

# MISSOURI UNIFORM CRASH REPORT PREPARATION MANUAL

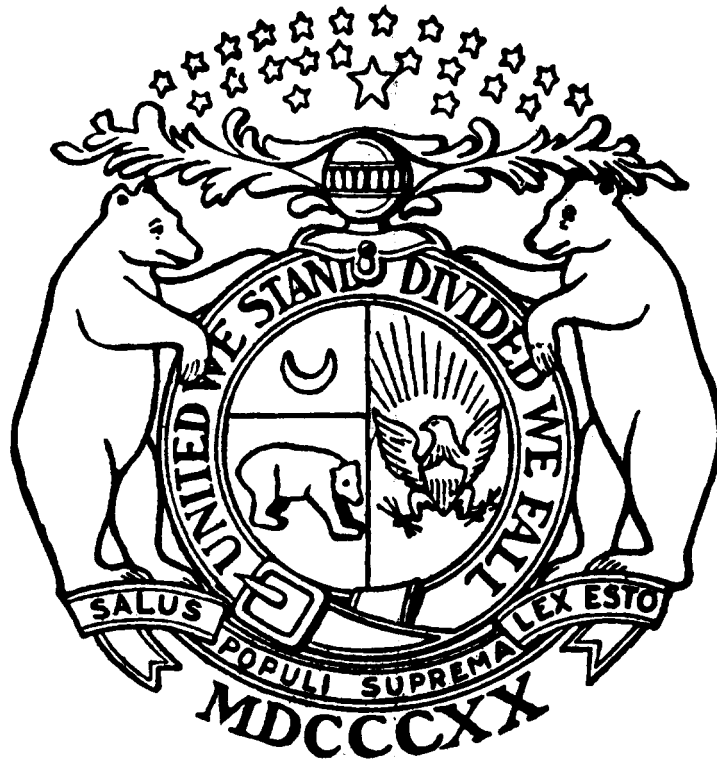

Revised  
January 1, 2024

**Prepared under the Direction of  
the Missouri STARS Committee**

Version 1.1



MISSOURI UNIFORM CRASH REPORT

1 - GENERAL CRASH INFORMATION				AGENCY NAME AND ORI			
SPACE USED FOR BARCODE							
LEFT THE SCENE	DRIVER NO.	CLEARED	CRASH CLASSIFICATION	PROPERTY DAMAGE ONLY	NO. INJURED	NO. KILLED	REPORT / CASE / INCIDENT NUMBER
<input type="checkbox"/> Yes <input type="checkbox"/> No		<input type="checkbox"/> Yes <input type="checkbox"/> No		<input type="checkbox"/>			
CRASH DATE MM/DD/YYYY	CRASH TIME (MIL)	NOTIFIED DATE	TIME NOTIFIED (MIL)	INVEST. DATE	TIME ARRIVED (MIL)	DATE OF RDWY. CLEAR	TIME OF RDWY. CLEAR
						<input type="checkbox"/> NA	<input type="checkbox"/> NA
CRASH TYPE	ROADWAY	NON-COLLISION	COLLISION INVOLVING		DIRECTIONAL ANALYSIS FOR IMPACT WITH MOTOR VEHICLE		
	<input type="checkbox"/> On Roadway <input type="checkbox"/> Off Roadway	<input type="checkbox"/> Overturning <input type="checkbox"/> Fire/Explosion <input type="checkbox"/> Immersion <input type="checkbox"/> Jackknife <input type="checkbox"/> Fall/Jumped From MV	<input type="checkbox"/> Cargo/Equip Loss/Shift <input type="checkbox"/> Other <input type="checkbox"/> Non-Collision <input type="checkbox"/> Thrower <input type="checkbox"/> Falling Object	<input type="checkbox"/> Animal <input type="checkbox"/> Pedalyclo <input type="checkbox"/> Fixed Object <input type="checkbox"/> Other Object	<input type="checkbox"/> Pedestrian <input type="checkbox"/> Struckby/Falling, Shifting Cargo or Anything Stat in Motion by Motor Vehicle <input type="checkbox"/> Railway Vehicle <input type="checkbox"/> Motor Vehicle in Transport <input type="checkbox"/> Parked Motor Vehicle <input type="checkbox"/> Working Motor Vehicle <input type="checkbox"/> Other Non-Motorist	<input type="checkbox"/> Front to Front <input type="checkbox"/> Front to Rear <input type="checkbox"/> Rear to Rear <input type="checkbox"/> Rear to Side <input type="checkbox"/> Angle (Front to Side)	<input type="checkbox"/> Sidewipe (Same Dir.) <input type="checkbox"/> Sidewipe (Opp. Dir.) <input type="checkbox"/> Other (Explain) <input type="checkbox"/> Unknown (Explain)
COMMERCIAL MOTOR VEHICLE INVOLVEMENT CRITERIA - Answer the following to determine if the "Commercial Vehicle" fields in Section 7H must be completed.							
1. Does this crash involve any of the following? 1a. A person fatally injured; OR 1b. A person transported for medical attention; OR 1c. A vehicle towed due to disabling damage.				2. Examine each vehicle to determine if it is a commercial vehicle based upon the following: 2a. A truck/cargo van with GVWR/GCWR of more than 10,000 lbs; OR 2b. A motor vehicle with seating for 9 or more including driver; OR 2c. A vehicle with a hazardous materials placard.			
EVIDENTIARY PHOTOS TAKEN		BY WHOM		AVAILABLE FROM		<input type="checkbox"/> Investigating Agency	
<input type="checkbox"/> Yes <input type="checkbox"/> No							
EVIDENTIARY VIDEO TAKEN		BY WHOM		AVAILABLE FROM		<input type="checkbox"/> Investigating Agency	
<input type="checkbox"/> Yes <input type="checkbox"/> No							
RECONSTRUCTION		BY WHOM		AVAILABLE FROM		<input type="checkbox"/> Investigating Agency	
<input type="checkbox"/> Yes <input type="checkbox"/> No							
2 - LOCATION							
COUNTY		MUNICIPALITY		BEAT / ZONE		TRP/DIST/PT	
						GPS COORDINATES (DD MM SS.S FORMAT)	
						LAT: N LONG: W	
ON				RDWY. DIR.		DISTANCE FROM	
				<input type="checkbox"/> NA Foot		LOCATION	
						<input type="checkbox"/> After <input type="checkbox"/> NA <input type="checkbox"/> Before <input type="checkbox"/> At	
SPEED LIMIT		ROADWAY MAINTAINED BY		SPEED LIMIT		INT. DIR.	
		<input type="checkbox"/> Unknown <input type="checkbox"/> State <input type="checkbox"/> County <input type="checkbox"/> Municipal <input type="checkbox"/> Private Property <input type="checkbox"/> Other				GEO - CODE	
TRAFFICWAY				ROADWAY ALIGNMENT		ROADWAY PROFILE	
<input type="checkbox"/> One-Way <input type="checkbox"/> Two-Way; Not Divided <input type="checkbox"/> Two-Way; Not Divided; Continuous Center Turn Lane				<input type="checkbox"/> Two-Way; Divided; Unprotected Median <input type="checkbox"/> Two-Way; Divided; Positive Median Barrier		<input type="checkbox"/> Other <input type="checkbox"/> Unknown (Explain)	
				<input type="checkbox"/> Straight <input type="checkbox"/> Curve <input type="checkbox"/> Unknown (Explain)		<input type="checkbox"/> Level <input type="checkbox"/> Downhill <input type="checkbox"/> Dip <input type="checkbox"/> Uphill <input type="checkbox"/> Hillcrest <input type="checkbox"/> Unknown (Explain)	
INTERSECTION TYPE		PERPENDICULAR		ANGLED/SKEWED		ROUNDABOUT / TRAFFIC CIRCLE	
<input type="checkbox"/> NA		<input type="checkbox"/> Cross Intersection (4-Way) <input type="checkbox"/> T-Intersection		<input type="checkbox"/> Y-Intersection <input type="checkbox"/> Five or More Legs and Not Circular		<input type="checkbox"/> Roundabout <input type="checkbox"/> Other Circular Intersection <input type="checkbox"/> Other (Explain) <input type="checkbox"/> Unknown (Explain)	
						Enter Codes	
						ROADWAY CONDITION	
						LIGHT CONDITION	
						WEATHER/ENVIRON CONDITION	
						ROADWAY SURFACE	
3 - DAMAGE TO PROPERTY OTHER THAN VEHICLES <input type="checkbox"/> None							
LIST OWNER'S NAME & ADDRESS, DESCRIPTION OF PROPERTY, AND DAMAGE. <input type="checkbox"/> MoDOT <input type="checkbox"/> County <input type="checkbox"/> Municipality							
4 - WITNESS <input type="checkbox"/> None Identified <input type="checkbox"/> Additional Witnesses In Narrative							
NAME & ADDRESS (Street, City, State, Zip)							PHONE NUMBER
5 - NON-MOTORIST <input type="checkbox"/> NA <input type="checkbox"/> Pedestrian <input type="checkbox"/> Pedestrian on Personal Conveyance <input type="checkbox"/> Pedalyclo <input type="checkbox"/> Other Non-Motorist							
(NOT OCCUPANT OF RAILWAY OR MOTOR VEHICLE)		<input type="checkbox"/> Prior Motor Vehicle Occupant <input type="checkbox"/> Yes <input type="checkbox"/> No		<input type="checkbox"/> Personal Conveyance Type (Enter Code) _____		<input type="checkbox"/> On Motorized Pedalyclo <input type="checkbox"/> No <input type="checkbox"/> Electric <input type="checkbox"/> Gas <input type="checkbox"/> Other (Explain)	
						<input type="checkbox"/> Occupant of Animal or Animal Drawn Device <input type="checkbox"/> Yes <input type="checkbox"/> No	
						PEDESTRIAN SPECIAL FUNCTION <input type="checkbox"/> NA	
						<input type="checkbox"/> Law Enforcement <input type="checkbox"/> Fire <input type="checkbox"/> Officer <input type="checkbox"/> ModOT Worker <input type="checkbox"/> Tow Operator <input type="checkbox"/> Other Trafficway Worker <input type="checkbox"/> EMS	
NO. NAME (Last, First, MI) & ADDRESS (Street, City, State, Zip)							PHONE NUMBER
DATE OF BIRTH		SEX	STRUCK BY VEH#:	INJ	TRANS. PORT	SAFETY DEVICES	LOCATION
							<input type="checkbox"/> In Driveway Access <input type="checkbox"/> On Roadway Within Crosswalk / Intersection <input type="checkbox"/> On Median / Separator / Crossing Island <input type="checkbox"/> On Sidewalk
							<input type="checkbox"/> In Driveway Access <input type="checkbox"/> On Roadway Outside Crosswalk / Intersection <input type="checkbox"/> On Median / Separator / Crossing Island <input type="checkbox"/> Shoulder / Roadside
							<input type="checkbox"/> Non-Trafficway Area <input type="checkbox"/> Shared-Use Path or Trail <input type="checkbox"/> Other (Explain) <input type="checkbox"/> Unknown
							BICYCLE LANE / FACILITY (Enter Code)
CROSSING ROAD <input type="checkbox"/> NA		ACTIONS <input type="checkbox"/> NA/None		ORIGIN / DESTINATION <input type="checkbox"/> NA			
<input type="checkbox"/> With Signal <input type="checkbox"/> Against Signal <input type="checkbox"/> No Signal <input type="checkbox"/> With Flashing Beacon <input type="checkbox"/> Unknown		<input type="checkbox"/> Intersection - Marked Crosswalk <input type="checkbox"/> Intersection - Unmarked Crosswalk <input type="checkbox"/> Midblock - Marked Crosswalk <input type="checkbox"/> Midblock - No Crosswalk <input type="checkbox"/> Unknown		<input type="checkbox"/> Getting On / Off Vehicle <input type="checkbox"/> Standing / Lying / Sitting in Trafficway <input type="checkbox"/> Pushing / Working on Vehicle <input type="checkbox"/> Behind / In Front of Parked / Stopped Veh.		<input type="checkbox"/> Working in Trafficway <input type="checkbox"/> Playing in Trafficway <input type="checkbox"/> Walking / Running / Cycling / Hiding in Trafficway <input type="checkbox"/> With Traffic <input type="checkbox"/> Against Traffic <input type="checkbox"/> Other (Explain) <input type="checkbox"/> Unknown	
						<input type="checkbox"/> Going To / From School <input type="checkbox"/> Getting On / Off School Bus <input type="checkbox"/> Both Of The Above <input type="checkbox"/> Going To / From Transit <input type="checkbox"/> Unknown (Explain)	
PROBABLE CONTRIBUTING CIRCUMSTANCES <input type="checkbox"/> None							
<input type="checkbox"/> Failed To Yield <input type="checkbox"/> Failure to Obey Traffic Signs, Signals, or Officer <input type="checkbox"/> Improper Lane Usage/Change		<input type="checkbox"/> Alcohol <input type="checkbox"/> Drugs <input type="checkbox"/> Wrong Way <input type="checkbox"/> Vision Obstructed (Explain)		<input type="checkbox"/> Physical Impairment (Explain) <input type="checkbox"/> Not Visible (Dark Clothing, No Lighting, etc.) <input type="checkbox"/> Improper Turn		<input type="checkbox"/> Improper Passing <input type="checkbox"/> Improper Signal <input type="checkbox"/> Improper Backing <input type="checkbox"/> Distracted / Inattentive (If marked, fill in Codes) ->	
						<input type="checkbox"/> Following Too Close <input type="checkbox"/> Improper Start from Park <input type="checkbox"/> In Roadway Improperly (Standing, Lying, Working, Playing, Stopped) <input type="checkbox"/> Other (Explain) <input type="checkbox"/> Unknown (Explain)	
						DISTRACTED / INATTENTIVE CODE(S) <input type="checkbox"/> NA ALCOHOL USE <input type="checkbox"/> Yes <input type="checkbox"/> No <input type="checkbox"/> Unknown	

6. COLLISION  
DIAGRAM

Compass Direction  
Before Crash Event(s)  
(Circle One)

**V1** N E S W U

**V2** N E S W U

**V3** N E S W U

**V4** N E S W U

**V5** N E S W U

**V6** N E S W U

INDICATE  
NORTH

INDICATE ROAD NAMES

DIAGRAM NOT TO SCALE

7 — DRIVERS, VEHICLES, OWNERS, & OCCUPANTS																														
7A. DRIVER — NAME (Last, First, MI) & ADDRESS (Street, City, State, Zip)										PHONE NUMBER																				
DRIVER LICENSE / ID NUMBER		STATE	LIC STATUS			LIC TYPE			ENDORSEMENTS																					
			<input type="checkbox"/> Valid <input type="checkbox"/> Expired <input type="checkbox"/> Susp / Rev / Denied <input type="checkbox"/> Dequal CDL <input type="checkbox"/> Cancelled / Oth Invalid <input type="checkbox"/> Unknown			<input type="checkbox"/> Operator Class _____ <input type="checkbox"/> Permit <input type="checkbox"/> Unknown (Explain) <input type="checkbox"/> CDL Class _____ <input type="checkbox"/> MC Only <input type="checkbox"/> Interm / Grad			<input type="checkbox"/> Yes (add code) <input type="checkbox"/> No <input type="checkbox"/> NA <input type="checkbox"/> Unk																					
DATE OF BIRTH	SEX	SEAT LOC	INJ	TRANS-PORT	EJECT-ION	AIR BAG	SAFETY DEVICES	INDICATION OF IMPROPER USE?	VISION OBSTRUCTED	Other (Explain)																				
								<input type="checkbox"/> Yes <input type="checkbox"/> No <input type="checkbox"/> Unk	<input type="checkbox"/> NA	<input type="checkbox"/> Moving Veh <input type="checkbox"/> Stopped Veh <input type="checkbox"/> Glare <input type="checkbox"/> Other (Explain) <input type="checkbox"/> Unknown (Explain)																				
DRIVER LICENSE RESTRICTIONS Alcohol Interlock Required on License? <input type="checkbox"/> Yes <input type="checkbox"/> No <input type="checkbox"/> Unknown <input type="checkbox"/> NA										Alcohol Interlock Present? <input type="checkbox"/> Yes <input type="checkbox"/> No <input type="checkbox"/> Unknown <input type="checkbox"/> NA																				
PROOF OF INSURANCE		INSURANCE COMPANY			PHONE NO. (Optional)			POLICY NUMBER			SAID																			
<input type="checkbox"/> Yes <input type="checkbox"/> No <input type="checkbox"/> Not Required											<input type="checkbox"/> Driver <input type="checkbox"/> Vehicle																			
7B. VEHICLE — OWNER NAME (Last, First, MI) & ADDRESS (Street, City, State, Zip)										PHONE NUMBER																				
										SAID																				
YEAR	MAKE	MODEL			COLOR	VEH. TYPE	TOTAL NO. OF OCC.																							
LICENSE — PLATE NO.		STATE	YEAR	VIN																										
TOWED FROM SCENE		TOWED BY			VEHICLE DAMAGE (Mark all damaged areas)				None / No Damage																					
<input type="checkbox"/> Yes <input type="checkbox"/> No		<input type="checkbox"/> Unknown <input type="checkbox"/> NA			INITIAL IMPACT NO: <table border="1" style="display: inline-table; vertical-align: middle;"><tr><td>2</td><td>3</td><td>4</td><td>5</td><td>6</td><td>7</td></tr><tr><td>1</td><td>15</td><td>16</td><td>17</td><td>8</td><td></td></tr><tr><td>14</td><td>13</td><td>12</td><td>11</td><td>10</td><td>9</td></tr></table>				2	3	4	5	6	7	1	15	16	17	8		14	13	12	11	10	9	18 - Undercarriage 22 - Cargo 19 - Windshield 23 - Unknown 20 - Burned 24 - Other (Explain) 21 - Trailer / Towed Unit			
2	3	4	5	6	7																									
1	15	16	17	8																										
14	13	12	11	10	9																									
TOWED DUE TO DIS. DAMAGE																														
<input type="checkbox"/> Yes <input type="checkbox"/> No																														
VEHICLE BODY TYPES — Automobiles / Specialty Vehicles <input type="checkbox"/> Vehicle Used As Public Conveyance <input type="checkbox"/> Vehicle Used for Electronic Ride-Hailing (Transportation Network Company)																														
<input type="checkbox"/> Passenger Car		<input type="checkbox"/> Small Bus (9-15 W/Driver)		<input type="checkbox"/> Motorcycle		<input type="checkbox"/> Autocycle		<input type="checkbox"/> Cargo Van		GW / GCW RATING (Not Licensed Weight) (Pickups, Cargo Vans, All Trucks, Truck Tractors, or Haz Mat Placed Veh. Only) <input type="checkbox"/> Less than or equal to 10,000 lbs. <input type="checkbox"/> 10,001 - 26,000 lbs. <input type="checkbox"/> Greater than 26,000 lbs. <input type="checkbox"/> Unknown																				
<input type="checkbox"/> Passenger Van (< 9 Seats)		<input type="checkbox"/> Large Bus (16+ W/Driver)		<input type="checkbox"/> ATV		<input type="checkbox"/> Recreational Off-Highway Vehicles (ROV)		<input type="checkbox"/> Pickup																						
<input type="checkbox"/> 9-12 Passenger Van								<input type="checkbox"/> Other Heavy Truck																						
<input type="checkbox"/> 15- Passenger Van								<input type="checkbox"/> Single-unit Truck; 2 axles, 6 tires																						
<input type="checkbox"/> Sport Utility Vehicle		<input type="checkbox"/> School Bus		<input type="checkbox"/> 2 Wh		<input type="checkbox"/> Motor Home		<input type="checkbox"/> Single-unit Truck; 3 or more axles																						
<input type="checkbox"/> Limousine (7-8 W/ Driver)		<input type="checkbox"/> Intercity		<input type="checkbox"/> 3 Wh		<input type="checkbox"/> Farm Implements		<input type="checkbox"/> Truck Tractor																						
<input type="checkbox"/> Limousine (9-15 W/ Driver)		<input type="checkbox"/> Transit / Commuter		<input type="checkbox"/> 4 Wh		<input type="checkbox"/> Construction Equip. Heavy Mach.																								
<input type="checkbox"/> Motorized Bicycle / Moped		<input type="checkbox"/> Charter / Tour		<input type="checkbox"/> 5 Wh / More		<input type="checkbox"/> Other Vehicle (Code) _____																								
		<input type="checkbox"/> Other		<input type="checkbox"/> Unknown		<input type="checkbox"/> Unknown (Explain)																								
								Number of Trailer / Towed Units: (Applies to all Vehicle Body Types MUST COMPLETE)																						
FIRST TRAILER / TOWED UNIT	YEAR	MAKE	MODEL			Record Subsequent Trailer / Towed Units in Section 9 — Narrative.																								
	LICENSE — PLATE NO.	STATE	YEAR	VIN																										
SECOND TRAILER / TOWED UNIT	YEAR	MAKE	MODEL																											
	LICENSE — PLATE NO.	STATE	YEAR	VIN																										
AUTOMATION SYSTEM OR SYSTEMS IN VEHICLE		If marked Yes, complete Automation System Levels Engaged at Time of Crash and Driver Coded Control fields			AUTOMATION SYSTEM LEVELS ENGAGED AT TIME OF CRASH				DRIVER CEDED CONTROL																					
<input type="checkbox"/> Yes <input type="checkbox"/> No <input type="checkbox"/> Unknown					<input type="checkbox"/> No Automation <input type="checkbox"/> Partial Automation <input type="checkbox"/> High Automation <input type="checkbox"/> Automation System(s) Engaged/Level/Unknown				<input type="checkbox"/> Yes <input type="checkbox"/> No <input type="checkbox"/> Unknown <input type="checkbox"/> NA																					
EMERGENCY VEHICLE INVOLVEMENT		A. Emergency Vehicle on Emergency Run			CONTRIBUTING TRAFFIC CONDITIONS																									
<input type="checkbox"/> Police <input type="checkbox"/> Ambulance <input type="checkbox"/> Fire <input type="checkbox"/> Other (Must check "A" or "B")		<input type="checkbox"/> A. Stationary With Emergency Equip. Activated			<input type="checkbox"/> Congestion Ahead <input type="checkbox"/> Crash Ahead <input type="checkbox"/> Other Incident Ahead <input type="checkbox"/> Unknown (Explain)																									
7C. VEHICLE ACTION / SEQUENCE OF EVENTS CODES <input type="checkbox"/> Additional Codes Listed in Narrative (See Codes in Section 8)																														
SEQUENCE OF EVENTS CODES						ANIMAL CODE(S)			FIXED OBJECT CODE(S)																					
<input type="checkbox"/> Unknown																														
ALCOHOL USE <input type="checkbox"/> Yes <input type="checkbox"/> No <input type="checkbox"/> Unknown <input type="checkbox"/> NA				MARIJUANA USE <input type="checkbox"/> Yes <input type="checkbox"/> No <input type="checkbox"/> Unknown <input type="checkbox"/> NA																										
7D. PROBABLE CONTRIBUTING CIRCUMSTANCES <input type="checkbox"/> Additional Codes Listed in Narrative (See Codes in Section 8)										DISTRACTED / INATTENTIVE CODE(S) (See Codes in Section 8)																				
										<input type="checkbox"/> NA																				
7E. WORK ZONE		TYPE OF WORK ZONE			LOCATION OF THE CRASH				LAW ENFORCEMENT PRESENT																					
<input type="checkbox"/> Yes <input type="checkbox"/> No <input type="checkbox"/> Unknown		<input type="checkbox"/> Lane Closure <input type="checkbox"/> Lane Shift / Crossover <input type="checkbox"/> Intermittent or Moving Work			<input type="checkbox"/> Before the First Work Zone Warning Sign <input type="checkbox"/> Advanced Warning Area				<input type="checkbox"/> Transition Area <input type="checkbox"/> Activity Area <input type="checkbox"/> Termination Area																					
Workers Present <input type="checkbox"/> Yes <input type="checkbox"/> No <input type="checkbox"/> Unknown		<input type="checkbox"/> Work on Shoulder or Median <input type="checkbox"/> Other Type of Work Zone <input type="checkbox"/> Unknown							<input type="checkbox"/> Yes <input type="checkbox"/> No <input type="checkbox"/> Unknown <input type="checkbox"/> NA																					
7F. TRAFFIC CONTROL		None <input type="checkbox"/> Unknown <input type="checkbox"/>			Electric: <input type="checkbox"/> Green / Yellow / Red <input type="checkbox"/> Flashing Red <input type="checkbox"/> Flashing Yellow <input type="checkbox"/> Ramp Meter <input type="checkbox"/> Other Electric (Explain)				CONTROL MALFUNCTIONING / INOPERATIVE / MISSING																					
Other Controls: <input type="checkbox"/> Stop Sign <input type="checkbox"/> Warning Sign / Device		<input type="checkbox"/> No Passing Zone <input type="checkbox"/> Railway Crossing Sign / Device			<input type="checkbox"/> Turn Restricted <input type="checkbox"/> School Zone <input type="checkbox"/> Officer / Flagman Yield Sign <input type="checkbox"/> Signal On School Bus <input type="checkbox"/> Other (Explain)				<input type="checkbox"/> Yes (Explain) <input type="checkbox"/> No <input type="checkbox"/> Unknown <input type="checkbox"/> NA																					
7G. OCCUPANTS — NAME (Last, First, MI) ADDRESS (Street, City, State, Zip)																														
DATE OF BIRTH	SEX	SEAT LOC	INJ	TRANS-PORT	EJECT-ION	AIR BAG	SAFETY DEVICES	IMPROPER USE?	PHONE NUMBER																					
								<input type="checkbox"/> Yes <input type="checkbox"/> No <input type="checkbox"/> Unk <input type="checkbox"/> NA																						
								<input type="checkbox"/> Yes <input type="checkbox"/> No <input type="checkbox"/> Unk <input type="checkbox"/> NA																						
								<input type="checkbox"/> Yes <input type="checkbox"/> No <input type="checkbox"/> Unk <input type="checkbox"/> NA																						
								<input type="checkbox"/> Yes <input type="checkbox"/> No <input type="checkbox"/> Unk <input type="checkbox"/> NA																						
								<input type="checkbox"/> Yes <input type="checkbox"/> No <input type="checkbox"/> Unk <input type="checkbox"/> NA																						

7 — DRIVERS, VEHICLES, OWNERS, & OCCUPANTS																													
7A. DRIVER — NAME (Last, First, MI) & ADDRESS (Street, City, State, Zip)										PHONE NUMBER																			
DRIVER LICENSE / ID NUMBER		STATE	LIC STATUS <input type="checkbox"/> Valid <input type="checkbox"/> Expired <input type="checkbox"/> Susp / Rev / Denied <input type="checkbox"/> Disqual CDL <input type="checkbox"/> NA <input type="checkbox"/> Canceled / Oth Invalid <input type="checkbox"/> Unknown			LIC TYPE <input type="checkbox"/> Operator Class _____ <input type="checkbox"/> Permit <input type="checkbox"/> Unknown (Explain) <input type="checkbox"/> CDL Class _____ <input type="checkbox"/> MC Only <input type="checkbox"/> NA <input type="checkbox"/> Intern / Grad <input type="checkbox"/> Unlicensed		ENDORSEMENTS <input type="checkbox"/> Yes (add code) <input type="checkbox"/> No <input type="checkbox"/> NA <input type="checkbox"/> Unk																					
DATE OF BIRTH	SEX	SEAT LOC	INJ	TRANS-PORT	EJEC-TION	AIR BAG	SAFETY DEVICES	INDICATION OF IMPROPER USE? <input type="checkbox"/> Yes <input type="checkbox"/> No <input type="checkbox"/> Unk <input type="checkbox"/> NA	VISION OBSTRUCTED <input type="checkbox"/> Not Obstructed <input type="checkbox"/> Windshield <input type="checkbox"/> Load on Veh <input type="checkbox"/> Trees / Brush <input type="checkbox"/> Building <input type="checkbox"/> Embankment <input type="checkbox"/> Sign <input type="checkbox"/> Hillcrest <input type="checkbox"/> Parked Veh <input type="checkbox"/> Moving Veh <input type="checkbox"/> Stopped Veh <input type="checkbox"/> Glare <input type="checkbox"/> Other (Explain) <input type="checkbox"/> Unknown (Explain)																				
DRIVER LICENSE RESTRICTIONS						Alcohol Interlock Required on License? <input type="checkbox"/> Yes <input type="checkbox"/> No <input type="checkbox"/> Unknown <input type="checkbox"/> NA		Alcohol Interlock Present? <input type="checkbox"/> Yes <input type="checkbox"/> No <input type="checkbox"/> Unknown <input type="checkbox"/> NA																					
PROOF OF INSURANCE <input type="checkbox"/> Yes <input type="checkbox"/> No <input type="checkbox"/> Not Required		INSURANCE COMPANY			<input type="checkbox"/> Expired		PHONE NO. (Optional)		POLICY NUMBER <input type="checkbox"/> NA		<input type="checkbox"/> Driver <input type="checkbox"/> Vehicle																		
7B. VEHICLE — OWNER NAME (Last, First, MI) & ADDRESS (Street, City, State, Zip) <input type="checkbox"/> SAD										PHONE NUMBER <input type="checkbox"/> SAD																			
YEAR	MAKE		MODEL			COLOR	VEH. TYPE	TOTAL NO. OF OCC.																					
LICENSE — PLATE NO. <input type="checkbox"/> Temporary Tag		STATE	YEAR	VIN																									
TOWED FROM SCENE <input type="checkbox"/> Yes <input type="checkbox"/> No		TOWED BY <input type="checkbox"/> Unknown <input type="checkbox"/> NA		VEHICLE DAMAGE (Mark all damaged areas)				<input type="checkbox"/> None / No Damage																					
TOWED DUE TO DIS. DAMAGE <input type="checkbox"/> Yes <input type="checkbox"/> No				INITIAL IMPACT NO: <table border="1" style="display: inline-table; border-collapse: collapse; text-align: center;"> <tr><td>2</td><td>3</td><td>4</td><td>5</td><td>6</td><td>7</td></tr> <tr><td>1</td><td>15</td><td>16</td><td>17</td><td>8</td><td></td></tr> <tr><td>14</td><td>13</td><td>12</td><td>11</td><td>10</td><td>9</td></tr> </table> <input type="checkbox"/> NA				2	3	4	5	6	7	1	15	16	17	8		14	13	12	11	10	9	18 - Undercarriage 22 - Cargo 19 - Windshield 23 - Unknown 20 - Burned 24 - Other 21 - Trailer / Towed Unit (Explain)			
2	3	4	5	6	7																								
1	15	16	17	8																									
14	13	12	11	10	9																								
VEHICLE BODY TYPES — Automobiles / Specialty Vehicles <input type="checkbox"/> Vehicle Used As Public Conveyance <input type="checkbox"/> Vehicle Used for Electronic Ride-Hailing (Transportation Network Company)																													
<input type="checkbox"/> Passenger Car		<input type="checkbox"/> Passenger Van (< 9 Seats)		<input type="checkbox"/> 9-12 Passenger Van		<input type="checkbox"/> 15- Passenger Van		<input type="checkbox"/> Sport Utility Vehicle		<input type="checkbox"/> Limousine (7-3W / Driver)																			
<input type="checkbox"/> Limousine (9-15 W / Driver)		<input type="checkbox"/> Motorized Bicycle / Moped		<input type="checkbox"/> Small Bus (9-15 W / Driver)		<input type="checkbox"/> Large Bus (16+ W / Driver)		<input type="checkbox"/> School Bus		<input type="checkbox"/> Intercity																			
<input type="checkbox"/> Transit / Commuter		<input type="checkbox"/> Charter / Tour		<input type="checkbox"/> Other		<input type="checkbox"/> Motorcycle		<input type="checkbox"/> ATV		<input type="checkbox"/> Autocycle																			
<input type="checkbox"/> Recreational Off-Highway Vehicles (ROV)		<input type="checkbox"/> Motor Home		<input type="checkbox"/> Farm Implements		<input type="checkbox"/> Construction Equip. Heavy Mach.		<input type="checkbox"/> Other Vehicle (Code)		<input type="checkbox"/> Unknown (Explain)																			
<input type="checkbox"/> Cargo Van		<input type="checkbox"/> Pickup		<input type="checkbox"/> Other Heavy Truck		<input type="checkbox"/> Single-unit Truck; 2 axles, 6 tires		<input type="checkbox"/> Single-unit Truck; 3 or more axles		<input type="checkbox"/> Truck Tractor																			
GW / GVW RATING (Not Licensed Weight) (Pickups, Cargo Vans, All Trucks, Truck Tractors, or Haz Mat Placard Veh. Only)		<input type="checkbox"/> Less than or equal to 10,000 lbs.		<input type="checkbox"/> 10,001 - 26,000 lbs.		<input type="checkbox"/> Greater than 26,000 lbs.		<input type="checkbox"/> Unknown		Number of Trailer / Towed Units: (Applies to all Vehicle Body Types MUST COMPLETE)																			
FIRST TRAILER / TOWED UNIT	YEAR	MAKE	MODEL			LICENSE — PLATE NO.		STATE	YEAR	VIN	Record Subsequent Trailer / Towed Units in Section 9 — Narrative.																		
SECOND TRAILER / TOWED UNIT	YEAR	MAKE	MODEL			LICENSE — PLATE NO.		STATE	YEAR	VIN																			
AUTOMATION SYSTEM OR SYSTEMS IN VEHICLE <input type="checkbox"/> Yes <input type="checkbox"/> No <input type="checkbox"/> Unknown		If marked Yes, complete Automation System Levels Engaged at Time of Crash and Driver Coded Control fields		AUTOMATION SYSTEM LEVELS ENGAGED AT TIME OF CRASH <input type="checkbox"/> No Automation <input type="checkbox"/> Partial Automation <input type="checkbox"/> High Automation <input type="checkbox"/> Driver Assistance <input type="checkbox"/> Conditional Automation <input type="checkbox"/> Full Automation <input type="checkbox"/> Unknown				Automation System(s) Engaged / Level / Unknown		DRIVER CEDED CONTROL <input type="checkbox"/> Yes <input type="checkbox"/> No <input type="checkbox"/> Unknown <input type="checkbox"/> NA																			
EMERGENCY VEHICLE INVOLVEMENT <input type="checkbox"/> NA		<input type="checkbox"/> Police <input type="checkbox"/> Ambulance <input type="checkbox"/> Fire <input type="checkbox"/> Other (Must check "A" or "B")		<input type="checkbox"/> A. Emergency Vehicle on Emergency Run <input type="checkbox"/> B. Stationary With Emergency Equip. Activated		CONTRIBUTING TRAFFIC CONDITIONS <input type="checkbox"/> NA <input type="checkbox"/> Congestion Ahead <input type="checkbox"/> Crash Ahead <input type="checkbox"/> Other Incident Ahead <input type="checkbox"/> Unknown (Explain)																							
7C. VEHICLE ACTION / SEQUENCE OF EVENTS CODES <input type="checkbox"/> Additional Codes Listed in Narrative (See Codes in Section 8)																													
SEQUENCE OF EVENTS CODES <input type="checkbox"/> Unknown						ANIMAL CODE(S)			FIXED OBJECT CODE(S)																				
ALCOHOL USE <input type="checkbox"/> Yes <input type="checkbox"/> No <input type="checkbox"/> Unknown <input type="checkbox"/> NA		MARIJUANA USE <input type="checkbox"/> Yes <input type="checkbox"/> No <input type="checkbox"/> Unknown <input type="checkbox"/> NA																											
7D. PROBABLE CONTRIBUTING CIRCUMSTANCES <input type="checkbox"/> Additional Codes Listed in Narrative (See Codes in Section 8)																													
<input type="checkbox"/> None <input type="checkbox"/> Unknown (Explain)		DISTRACTED / INATTENTIVE CODE(S) (See Codes in Section 8)				<input type="checkbox"/> NA																							
7E. WORK ZONE <input type="checkbox"/> Yes <input type="checkbox"/> No <input type="checkbox"/> Unknown		TYPE OF WORK ZONE <input type="checkbox"/> NA		LOCATION OF THE CRASH <input type="checkbox"/> NA <input type="checkbox"/> Unknown		LAW ENFORCEMENT PRESENT <input type="checkbox"/> Yes <input type="checkbox"/> No <input type="checkbox"/> Unknown <input type="checkbox"/> NA																							
Workers Present <input type="checkbox"/> Yes <input type="checkbox"/> No <input type="checkbox"/> Unknown		<input type="checkbox"/> Lane Closure <input type="checkbox"/> Lane Shift / Crossover <input type="checkbox"/> Intermittent or Moving Work <input type="checkbox"/> Unknown		<input type="checkbox"/> Work on Shoulder or Median <input type="checkbox"/> Other Type of Work Zone		<input type="checkbox"/> Before the First Work Zone Warning Sign <input type="checkbox"/> Advanced Warning Area		<input type="checkbox"/> Transition Area <input type="checkbox"/> Activity Area <input type="checkbox"/> Termination Area																					
7F. TRAFFIC CONTROL <input type="checkbox"/> None <input type="checkbox"/> Unknown		Electric: <input type="checkbox"/> Green / Yellow / Red <input type="checkbox"/> Flashing Red		<input type="checkbox"/> Flashing Yellow <input type="checkbox"/> Ramp Meter <input type="checkbox"/> Other Electric (Explain)		CONTROL MALFUNCTIONING / INOPERATIVE / MISSING <input type="checkbox"/> Yes (Explain) <input type="checkbox"/> No <input type="checkbox"/> Unknown <input type="checkbox"/> NA																							
Other: <input type="checkbox"/> Stop Sign <input type="checkbox"/> Warning Sign / Device		<input type="checkbox"/> No Passing Zone <input type="checkbox"/> Railway Crossing Sign / Device		<input type="checkbox"/> Turn Restricted <input type="checkbox"/> School Zone		<input type="checkbox"/> Officer / Flagman <input type="checkbox"/> Yield Sign		<input type="checkbox"/> Signal On School Bus <input type="checkbox"/> Other (Explain)																					
7G. OCCUPANTS — NAME (Last, First, MI)		DATE OF BIRTH	SEX	SEAT LOC	INJ	TRANS-PORT	EJEC-TION	AIR BAG	SAFETY DEVICES	IMPROPER USE? <input type="checkbox"/> Yes <input type="checkbox"/> No <input type="checkbox"/> Unk <input type="checkbox"/> NA	PHONE NUMBER																		
ADDRESS (Street, City, State, Zip)		MM-DD-YYYY								<input type="checkbox"/> Yes <input type="checkbox"/> No <input type="checkbox"/> Unk <input type="checkbox"/> NA																			
										<input type="checkbox"/> Yes <input type="checkbox"/> No <input type="checkbox"/> Unk <input type="checkbox"/> NA																			
										<input type="checkbox"/> Yes <input type="checkbox"/> No <input type="checkbox"/> Unk <input type="checkbox"/> NA																			
										<input type="checkbox"/> Yes <input type="checkbox"/> No <input type="checkbox"/> Unk <input type="checkbox"/> NA																			
										<input type="checkbox"/> Yes <input type="checkbox"/> No <input type="checkbox"/> Unk <input type="checkbox"/> NA																			

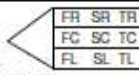
<b>7H — COMMERCIAL MOTOR VEHICLE</b> <input type="checkbox"/> NA		Required on vehicle if "Yes" was answered to questions in parts 1 and 2 in CMV involvement criteria and vehicle meets one of the three criteria in part 2.	
VEH NO.	MOTOR CARRIER IDENTIFICATION (Lessee, etc.) — NAME & ADDRESS (Street, City, State, Zip) <input type="checkbox"/> SAC		PHONE NUMBER <input type="checkbox"/> SAC
COMMERCIAL/ NON-COMMERCIAL	<input type="checkbox"/> Interstate Carrier <input type="checkbox"/> Intrastate Carrier	<input type="checkbox"/> Not In Commerce — Government Vehicle <input type="checkbox"/> Not In Commerce — Rental Vehicle	<input type="checkbox"/> Not In Commerce — Other Vehicle MC / MX / ICC NO.
CARGO BODY TYPE	<input type="checkbox"/> Enclosed Box <input type="checkbox"/> Cargo Tank	<input type="checkbox"/> Flatbed <input type="checkbox"/> Dump	<input type="checkbox"/> Concrete Mixer <input type="checkbox"/> Auto Transporter
	<input type="checkbox"/> Garbage/Refuse <input type="checkbox"/> Grain/Chip/Gravel	<input type="checkbox"/> Pole Trailer <input type="checkbox"/> Log	<input type="checkbox"/> Vehicle Towing Another Veh. <input type="checkbox"/> Intermodal Container Chassis <input type="checkbox"/> NA (No Cargo Body) <input type="checkbox"/> Other <input type="checkbox"/> Unknown
HAZARDOUS MATERIALS	PLACARD DISPLAYED <input type="checkbox"/> Yes <input type="checkbox"/> No <input type="checkbox"/> Unknown	4-DIGIT NO.	CLASS
			HM CARGO PRESENT <input type="checkbox"/> Yes <input type="checkbox"/> No <input type="checkbox"/> Unknown
			HM CARGO RELEASED <input type="checkbox"/> Yes <input type="checkbox"/> No <input type="checkbox"/> Unknown
HAZARDOUS MATERIAL NAME			
<b>8 — CODES</b>			
<b>ROADWAY CONDITION CODES</b>		<b>ROADWAY SURFACE CODES</b>	
1. Dry 2. Wet 3. Snow 4. Ice/Frost 5. Slush 7. Standing Water		8. Moving Water 9. Other (Explain) 11. Mud, Dirt, Gravel 12. Sand U. Unknown (Explain)	
		1. Concrete 2. Asphalt 3. Brick 4. Gravel 5. Dirt/Sand	
		6. Multi surface 7. Cobblestone 8. Other (Explain) U. Unknown (Explain)	
		<b>LIGHT CONDITION CODES</b>	
		1. Daylight 2. Dark-Lighted 3. Dark-Unlighted 6. Dark-Unknown Lighting 7. Other (Explain) 8. Dawn/Dusk U. Unknown (Explain)	
		<b>WEATHER/ ENVIRONMENTAL CONDITION CODES</b>	
		1. Clear 2. Cloudy 3. Rain 4. Snow 5. Sleet/Hail 6. Freezing (Temp)	
		7. Fog/Mist 10. Severe Crosswinds 11. Other (Explain) 12. Blowing Snow 13. Smoke/Smog U. Unknown (Explain)	
<b>SEAT LOCATION</b>		<b>INJURY</b> (Enter Numerical Value)	<b>TRANSPORTED</b> (For Medical Treatment)
XX — Not Known M — Motorcycle CP — Commercial/Passenger OE — Occupant — Enclosed Load Area OU — Occupant — Unenclosed Load Area RC — Rail Car VE — Riding on Motor Vehicle Exterior (non-trailing unit) SS — Sleeper Section of Cab (truck) TU — Trailing Unit SV — Other (Explain in Narrative) NA — Not Applicable		1. (K) Fatal Injury 2. (A) Suspected Serious Injury 3. (B) Suspected Minor Injury 4. (C) Possible Injury 5. (O) No Apparent Injury U. Unknown N. NA	1. No 2. EMS 3. Other U. Unknown N. NA
			<b>EJECTION</b>
			1. NA 2. No 3. Partially 4. Totally U. Unknown
			<b>AIRBAG</b>
			1. None / Not Applicable 3. Not Deployed 4. Removed 5. Deployed — Front 6. Deployed — Side 7. Deployed — Curtain 8. Deployed — Other (Knee, Air Belt, etc.) 10. Deployment Unknown U. Air Bag Presence Unknown
			<b>SAFETY DEVICES</b>
			1. None 2. Not Used 3. Shoulder Belt Only 4. Lap Belt Only 5. Shoulder and Lap Belt 7. DOT Compliant MC Helmet 8. No Helmet 10. Booster Seat 11. Child Restraint — Forward Facing 12. Child Restraint — Rear Facing
			13. Other Helmet 14. Reflective Clothing 15. Other (Explain) 16. Child Restraint — Type Unknown 17. Stretcher 19. Wheelchair 19. Lighting 20. Reflectors U. Use Unknown N. Not Applicable
<b>PERSONAL CONVEYANCE TYPE CODES</b>		<b>BICYCLE LANE/ FACILITY CODES</b>	
1. Scooter — Mobility Assistance/Motorized 2. Scooter — Stand-up/Motorized 3. Stand-up/Non-motorized 4. Stand-up/Motorized-Other		1. Signed Route (No Pavement Marking) 2. Shared Lane Markings 3. On-street Bike Lanes 4. On-street Buffered Bike Lanes 5. Separated Bike Lanes	
		6. Off-street Trails/ Sideways 7. Other (Explain) U. Unknown N. Not Applicable	
<b>DISTRACTED / INATTENTIVE CODES</b>			
1. External Distraction 2. Passengers 3. Stereo / Audio / Video Equipment 4. Navigation Device			
5. Communication Device — Hand-held 6. Communication Device — Hands-Free 7. Communication Device — Texting/ E-mailing 8. Communication Device — Web Browsing			
9. Eating / Drinking 10. Reading 11. Tobacco Use 12. Grooming			
13. Computer Equipment / Electronic Games / etc. 14. Adjusting Vehicle Controls 15. Other (Explain)			
<b>ENDORSEMENT CODES</b>			
1. H — Hazardous Materials 2. N — Tank Vehicle 3. P — Passenger 4. S — School 5. T — Double/ Triple Trailers 6. X — Combination of Tank Vehicle and Hazardous Materials 7. Other Non-commercial License Endorsements (e.g., Motorcycle, etc.)			
<b>VEHICLE TYPE CODES</b>		<b>OTHER VEHICLE CODES</b>	
1. Motor Vehicle In Transport 2. Parked Motor Vehicle 3. Working Motor Vehicle U. Unknown		1. Riding Mower / Garden Tractor 2. Golf Cart 3. Snowmobile 4. Forklift 6. Low Speed Vehicle (LSV) 7. Other (Explain)	
<b>VEHICLE ACTION / SEQUENCE OF EVENTS</b> (Items with double-asterisk [**] require additional coding)			
1. Going Straight 2. Overtaking 3. Making Right Turn 4. Right Turn on Road 5. Making Left Turn 6. Making U-Turn 7. Skidding/ Sliding 8. Slowing/ Stopping 9. Start in Traffic 10. Start From Parked 11. Backing 12. Stopped in Traffic 13. Parked 14. Changing/ Merging Lanes			
15. Avoiding 16. Cross Median 17. Cross Center Off Road 18. Cross Road 19. Airborne 20. Ran Off Roadway — Right 21. Ran Off Roadway — Left 22. Overturn/ Rollover 23. Fire/ Explosion 24. Immersion 25. Jackknife 26. Cargo/ Equipment Loss/ Shift 27. Equipment Failure			
28. Separation Of Units 29. Returned To Roadway 30. Collision Inv. Pedestrian (**) 31. Collision Inv. Bicycle/ Pedaicycle (**) 32. Collision Inv. Railway Vehicle 33. Collision Inv. Animal (**) 34. Collision Inv. MV in Transport 35. Collision Inv. Parked MV 36. Collision Inv. Fixed Object (**) 37. Collision Inv. Other Object (Explain) 38. Other Non-collision 41. Collision Inv. Working MV 42. Downhill Runaway			
43. Fall/ Jumped From MV 44. Thrown/ Falling Object 46. Ran Off Roadway — Other (Explain) 47. Cross Separator 48. Collision Inv. Other Non-motorist (**) 49. Struck By Falling, Shifting Cargo, Object Set in Motion by Motor Vehicle 50. End Departure (T-intersection, Dead-end, etc.)			
<b>ANIMAL CODES FOR VEHICLE ACTION / SEQUENCE OF EVENTS</b>			
60. Deer 61. Farm Animal 62. Dog 63. Other Animal U. Unknown			
<b>FIXED OBJECT CODES FOR VEHICLE ACTION / SEQUENCE OF EVENTS</b>			
20. Tree/ Stump (Standing) 21. Embankment/ Driveway/ Ground/ Rock Bluff 22. Guardrail Face 23. Utility Pole/ Guy Wire 24. Fence 25. Street Light Support			
26. Culvert 27. Highway Traffic Sign Post/ Support 28. Bridge Pier/ Abutment/ Support 29. Curb 30. Mail Box 31. Concrete Traffic Barrier			
32. Building 33. Traffic Signal/ Support 34. Impact Attenuator/ Crash Cushion 35. Fire Hydrant 36. Other (Explain) 37. Bridge Parapet End			
38. Bridge Rail 39. Guardrail End 40. Other Traffic Barrier 41. Overhead Sign Support 42. Ditch 43. Other Post/ Pole/ Support			
44. Wall 45. Cable Barrier 46. Bridge Overhead Structure 47. Overhead Line/ Cable U. Unknown			
<b>PROBABLE CONTRIBUTING CIRCUMSTANCES</b> (Items with double-asterisk [**] require additional coding)			
1. Vehicle Defects (Explain) 3. Improperly Stopped in Roadway 4. Speed — Exceeded Limit 5. Too Fast For Conditions 6. Improper Passing 7. Failure to Obey Traffic Signs, Signals, or Officer 8. Wrong Side (Not Passing) 9. Following Too Close			
10. Improper Signal 11. Improper Backing 12. Improper Turn 13. Improper Lane Usage/ Change 14. Wrong Way 15. Improper Start From Park 16. Improperly Parked 17. Failed To Yield 18. Alcohol			
19. Drugs 20. Physical Impairment (Explain) 21. Distracted/ Inattentive (**) 22. Vision Obstructed 23. Driver Fatigue/ Asleep 25. Failed to Dim Headlights 26. Failed to Use Lights 27. Improper Towing/ Pushing 28. Overcorrected			
29. Improper Riding/ Clinging To Vehicle Exterior 30. Failed To Secure Load/ Improper Loading 31. Animal(s) In Roadway 32. Object/ Obstruction in Roadway 33. Other (Explain)			





11. NARRATIVE / STATEMENTS CONTINUATION (If additional room is necessary use Narrative / Statements Continuation / Supplement)

A large rectangular area with horizontal ruling lines, intended for writing a narrative or continuation of statements.



# TABLE OF CONTENTS

	Page
<b>GENERAL INFORMATION</b>	
I. <a href="#">Introduction</a> .....	5
II. <a href="#">Purpose</a> .....	5
III. <a href="#">Authority</a> .....	5
IV. <a href="#">Missouri STARS Committee</a> .....	6
<b>GENERAL RULES</b>	
I. <a href="#">Reporting Criteria</a> .....	7
II. <a href="#">General Completion and Submission Procedures</a> .....	7
III. <a href="#">Collision Diagramming</a> .....	9
IV. <a href="#">Photos Taken / Video Taken / Reconstruction</a> .....	9
<b><a href="#">GLOSSARY OF GENERAL TERMS AND DEFINITIONS</a></b> .....	10
<b>SPECIFIC RULES FOR COMPLETING THE MISSOURI UNIFORM CRASH REPORT</b>	
Section 1 - <a href="#">General Crash Information</a> .....	27
Left the Scene / Driver No. / Cleared .....	27
Crash Classification .....	27
Report / Case / Incident Number .....	28
No. Veh. Inv. ....	28
Crash Date / Time .....	28
Notified Date / Time .....	28
Investigation Date .....	28
Time Arrived .....	28
Date of Roadway Clearance .....	28
Time of Roadway Clearance .....	29
Invest. at Scene .....	29
Crash Type .....	29
Roadway .....	29
Non-Collision .....	29
Collision Involving .....	30
Directional Analysis .....	36
Commercial Motor Vehicle Involvement Criteria .....	39
Evidentiary Photos Taken .....	40
Evidentiary Video Taken .....	40
Reconstruction .....	40
Section 2 - <a href="#">Location</a> .....	41
County / Municipality .....	41
Beat / Zone .....	41
Trp / Dist / Pct .....	41
GPS Coordinates .....	41
On .....	41
Rdwy. Dir. ....	43
Distance From .....	43
Location .....	43
Intersecting .....	44
Private Property Crash Examples .....	46
Speed Limit (On Street) .....	47
Roadway Maintained By .....	47
Speed Limit (Intersecting) .....	47
Int. Dir .....	48
Geo Code .....	48
Trafficway .....	48
Roadway Alignment .....	49
Roadway Profile .....	49
Intersection Type .....	50
Roadway Condition .....	51

Light Condition .....	51
Roadway Surface .....	51
Weather / Environmental Condition .....	51
Section 3 - <u>Damage to Property Other Than Vehicles</u> .....	52
Section 4 - <u>Witness</u> .....	53
Section 5 - <u>Non-Motorist (Not Occupant of Railway or Motor Vehicle)</u> .....	54
NA .....	54
Pedestrian .....	54
Pedestrian on Personal Conveyance .....	55
Pedalcyclist .....	55
Other Non-Motorist .....	55
Pedestrian Special Function .....	56
No. ....	56
Name / Address / Phone Number .....	56
DOB / Sex / Struck by Veh. # / Inj. ....	56
Transport .....	57
Safety Devices .....	57
Location .....	57
Bicycle Lane / Facility .....	58
Crossing Road .....	58
Actions .....	60
Origin / Destination .....	61
Probable Contributing Circumstances .....	61
Distracted / Inattentive Codes .....	63
Alcohol Use .....	63
Section 6 - <u>Collision Diagram</u> .....	64
Section 7 - <u>Drivers, Vehicles, Owners, &amp; Occupants</u> .....	66
Page Not Used .....	66
No. ....	66
A. <u>Driver</u> .....	66
Driver Name / Address / Phone Number .....	66
Driver License / ID Number .....	66
State / Lic. Status .....	67
Lic. Type .....	68
Endorsements .....	68
DOB / Sex / Seat Location / Injury .....	69
Transport, Ejection, Air Bag .....	69
Saf. Dev., .....	70
Vision Obstructed .....	70
Driver License Restrictions - Alcohol Interlock Required on License?, Alcohol Interlock Present? .....	71
Insurance - Proof .....	71
Insurance - Company, Phone, Policy Number, Driver / License .....	72
B. <u>Vehicle</u> .....	73
Owner Name / Address / Phone Number .....	73
Vehicle Year / Make / Model / Color .....	73
Veh. Type .....	74
Total No. of Occ. ....	74
License - Plate No. ....	74
Temporary Tag / State / Year / VIN .....	75
Towed From Scene .....	75
Towed Due to Dis. Damage .....	75
Towed By .....	75

Vehicle Damage.....	76
Vehicle Body Types .....	76
GVW / GCVW Rating.....	81
First Trailer Towed / Unit, Second Trailer Towed / Unit.....	82
Automation System or Systems in Vehicle .....	83
Automation System Levels Engaged at Time of Crash .....	84
Driver Ceded Control .....	85
Emergency Vehicle Involvement.....	85
Contributing Traffic Conditions.....	86
C. <u>Vehicle Action / Sequence of Events Codes</u> .....	86
Additional Codes Listed in Narrative.....	87
Sequence of Events Codes .....	87
Animal Codes.....	87
Fixed Object Codes .....	87
Alcohol Use.....	87
Marijuana Use.....	87
D. <u>Probable Contributing Circumstances</u> .....	88
Distracted / Inattentive Codes.....	88
E. <u>Work Zone-Related</u> .....	88
Work Zone.....	88
Workers Present .....	89
Type of Work Zone .....	90
Location of the Crash.....	90
Law Enforcement Present.....	91
F. <u>Traffic Control</u> .....	91
Control Malfunctioning / Inoperative / Missing .....	94
G. <u>Occupants</u> .....	94
Name / Address .....	95
DOB, Sex, Seat Loc., Inj., Transport, Ejection .....	95
Air Bag, Saf. Dev., Improper Use?, Phone Number .....	96
H. <u>Commercial Motor Vehicle</u> .....	96
NA .....	97
Veh No. ....	97
Motor Carrier ID - Name / Address / Phone Number.....	97
Commercial / Non-Commercial.....	97
MC / MX / ICC No. ....	98
USDOT No. ....	98
Cargo Body Type .....	98
Hazardous Materials .....	100
Placard Displayed .....	100
4-Digit No. ....	100
Class .....	101
HM Cargo Present .....	101
HM Cargo Released .....	101
Hazardous Material Name .....	101
Section 8 - <u>Codes</u> .....	102
Road Condition .....	102
Road Surface .....	103
Light Condition .....	103
Weather / Environmental Condition .....	104
Seat Location .....	105
Injury .....	106
Transported.....	107

Ejection.....	108
Air Bag.....	109
Safety Devices .....	110
Personal Conveyance Type Codes .....	112
Bicycle Lane / Facility Codes .....	114
Distracted / Inattentive Codes.....	115
Endorsements Codes.....	116
Vehicle Type Codes.....	117
Other Vehicle Codes.....	118
Vehicle Action / Sequence of Events.....	119
Animal Codes for Vehicle Action / Sequence of Events .....	123
Fixed Object Codes for Vehicle Action / Sequence of Events .....	123
Probable Contributing Circumstances .....	129
Section 9 - <u>Narrative / Statements</u> .....	132
Section 10 - <u>Reporting and Reviewing Officer Information</u> .....	134
Section 11 - <u>Narrative / Statements Continuation</u> .....	134
<b><u>MISSOURI UNIFORM CRASH REPORT CONTINUATION / SUPPLEMENT</u></b> .....	135
<b><u>RAILWAY VEHICLE CRASH CONTINUATION / SUPPLEMENT</u></b> .....	137
<b>APPENDIX A - <u>SHORT FORM INFORMATION</u></b> .....	149
<b>APPENDIX B - <u>DIAGRAMMING METHODS</u></b> .....	150
<b>APPENDIX C - <u>UNITED STATES, CANADA, &amp; MEXICO ABBREVIATIONS</u></b> .....	155
<b>APPENDIX D - <u>COMMERCIAL MOTOR VEHICLES</u></b> .....	156
How To Find the Correct U.S. Dot / ICC # And Carrier Name.....	156
Guidelines for Identifying Hazardous Materials by Shipping Papers.....	157
<b>APPENDIX E - <u>CLASSIFYING AND LOCATING CRASHES</u></b> .....	158
Non-intersection .....	158
Intersections .....	167
Roundabouts / Traffic Circles / Connectors .....	175
Interchanges .....	178
Diamond .....	178
Cloverleaf.....	184
Diverging Diamond .....	187
Directional or Combination .....	190
Junctions .....	193
Bridges .....	195
Rest Areas / Weigh Stations .....	196
Reversible Lanes .....	198
Driveway Access.....	199
Parking Lots / Private Roads.....	200
<b>APPENDIX F - <u>MISCELLANEOUS TABLES</u></b> .....	206
Time Chart.....	206
Roadway Name Abbreviations.....	206
Route Designation Abbreviations.....	206
Color Abbreviations.....	207
Trafficway Cross Section .....	207
<b>APPENDIX G - <u>DRIVER LICENSE STATUS AND TYPE</u></b> .....	209

# GENERAL INFORMATION

## I. Introduction

The Statewide Traffic Accident Records System (STARS) program, renamed Missouri Crash Analysis Reporting System (MOCARS), began in July 1971 with a grant through the National Highway Traffic Safety Administration. The purpose of MOCARS is to provide timely and accurate motor vehicle traffic crash information to federal, state, and local users in order to support both operational and management functions in motor vehicle traffic safety. The Missouri State Highway Patrol was selected as the statewide repository for motor vehicle crash data/reports and was given the responsibility of training law enforcement officers throughout the State on completing the MOCARS crash report form. The Missouri State Highway Patrol provides a means for collecting, processing, and analyzing crash data.

In January 1974, after approximately 2 ½ years of research, development, and testing, the Missouri State Highway Patrol, Traffic Division, (renamed Patrol Records Division) began receiving crash reports on a statewide basis. The Patrol Records Division codes and classifies the reports for entry into the MOCARS database and provides users with tools to compile various MOCARS statistical reports.

There have been six major revisions to MOCARS since its inception. These revisions have resulted in major changes to the Missouri Uniform Crash Report form, as well as field reporting procedures. Revisions occurred, in some instances to comply with federal guidelines, in 1984, 1993, 1996, 2002, 2012, 2019, and January 1, 2024.

## II. Purpose

All motor vehicle crash reports received by the Patrol Records Division are archived for permanent preservation and computerized. Where appropriate, and in compliance with federal and state laws, hard copies of the reports and / or data are furnished to numerous federal, state, local, and private entities for analysis.

The Patrol Records Division is responsible for maintaining the official count of motor vehicle crash fatalities for the state of Missouri. This information, which is current to the previous midnight, is disseminated daily to other agencies through the Missouri Uniform Law Enforcement System (MULES). Without MOCARS, it would be almost impossible to keep an up-to-date and accurate count of motor vehicle crash deaths in Missouri.

## III. Authority

MOCARS' authority and obligation for reporting are specified in the following Missouri statutes:

43.250. Law enforcement officers to file accident reports with patrol, when - Every law enforcement officer who investigates a vehicle accident resulting in **injury** to or death of a person, or total property **damage** to an apparent extent of five hundred dollars or more to one person, or who otherwise prepares a written or computer-generated report as a result of an investigation either at the time of and at the scene of the accident or thereafter by interviewing the participants or witnesses, shall forward a report of such accident to the superintendent of the Missouri state highway patrol within ten days after his or her investigation of the accident, except that upon the approval of the superintendent of the Missouri state highway patrol the report may be forwarded at a time and/or in a form other than as required in this section.

43.251. Report form-how provided, contents—approval by superintendent. – 1. The Missouri division of highway safety shall prepare and upon request supply to police departments, sheriffs, and other appropriate agencies or individuals forms for written accident reports as required by section 43.250 and this section. Reports shall call for sufficiently detailed information to disclose, with reference to a vehicle accident, the cause, conditions then existing, and the persons and vehicles involved.

2. Every written or computer-generated accident report required to be made shall be submitted on the appropriate form or in the appropriate computer format approved by the superintendent of the Missouri state highway patrol and shall contain all the information required therein unless not available.

#### **IV. Missouri STARS Committee**

Although MOCARS / STARS has satisfied a great number of traffic crash data requirements since its inception, certain deficiencies were identified which limited its capability. The intent of the STARS Committee is to provide the necessary direction and coordination required to make improvements to MOCARS and the Missouri Uniform Crash Report. The committee also approved renaming the Statewide Traffic Accident Records System (STARS) to the Missouri Crash Analysis Reporting System (MOCARS) to align with the national transition of the term "accident" to "crash."

The Standing Committee is appointed by the Superintendent of the Missouri State Highway Patrol and meets as necessary to review the crash report form and related procedures. Additional agencies may be appointed by the Superintendent.

The following agencies are currently represented on the Standing Committee:

- Cape Girardeau Police Department
- Federal Highway Administration
- Federal Motor Carrier Safety Administration
- Jefferson City Police Department
- Kansas City Police Department
- Platte County Sheriff's Department
- Missouri Department of Health and Senior Services
- Missouri Department of Revenue
- Missouri Department of Transportation
- Missouri Safety Center
- Missouri State Highway Patrol
- National Highway Traffic Safety Administration
- St. Charles County Police Department
- St. Joseph Police Department
- St. Louis County Department of Transportation
- St. Louis County Police Department
- St. Louis Metropolitan Police Department
- Springfield Police Department
- Town and Country Police Department



## GENERAL RULES

### I. Reporting Criteria

Refer to the table below for MOCARS requirements. Incidents that meet the criteria of [deliberate intent](#), [legal intervention](#), and/or [cataclysm](#) are not considered motor vehicle crashes. When available information is insufficient to determine whether the crash was the result of deliberate intent, legal intervention, and/or cataclysm, treat the event as a motor vehicle crash. A motor vehicle crash report may be completed as a supplement to the investigative / incident report. In these instances, where a fatality occurred, a copy of the crash and/or incident report should be submitted to the Missouri State Highway Patrol, Patrol Records Division, for review.

	CLASS OF CRASH	TYPE OF REPORT FORM REQUIRED
1.	Crash involving a death or a personal injury	Long Form
2.	Property damage crashes (\$500 and above)	
	a. An emergency vehicle	Long Form
	b. Hazardous materials	Long Form
	c. Damage to government property	Long Form
	d. A <a href="#">public conveyance</a> (includes all school buses)	Long Form
	e. A driver <a href="#">leaving the scene</a> of a crash	Long Form
	f. Completion of Commercial Motor Vehicle Subsection 7H	Long Form
	g. A <a href="#">non-motorist</a>	Long Form
	h. A <a href="#">railway vehicle</a>	Long Form
3.	All other <a href="#">property damage</a> crashes (\$500 and above)	Long or Short Form
4.	All <a href="#">property damage</a> crashes less than \$500	Report not Required for MOCARS Entry

The short form consists of the areas on the crash report with captions or borders shaded gray or yellow. These areas are only minimum requirements. Individual departments may require additional fields to be completed for their own use. (See [Appendix A](#), page 149, for a list of short form fields).

### II. General Completion and Submission Procedures

- a. All crash reports must be typed or printed legibly. Do not write the report in long hand (cursive). Computer generated report forms must be approved by the Missouri State Highway Patrol's Patrol Records Division prior to use. Electronic submission of motor vehicle crash reports/data must also be approved by the Patrol Records Division prior to implementation.

LEFT THE SCENE <input checked="" type="checkbox"/> Yes <input type="checkbox"/> No	DRIVER NO.	CLEARED <input checked="" type="checkbox"/> Yes <input type="checkbox"/> No	CRASH CLASSIFICATION	PROPERTY DAMAGE ONLY <input type="checkbox"/>	NO. INJURED 1	NO. KILLED 0	REPORT / CASE / INCIDENT NUMBER 01011200025	NO. VEH. INV. 2
CRASH DATE 01/01/2024	CRASH TIME (MIL.) 0130	NOTIFIED DATE 01/01/2024	TIME NOTIFIED (MIL.) 0145	INVEST. DATE 01/01/2024	TIME ARRIVED (MIL.) 0205	DATE OF RDWY. CLEAR 01/01/2024 <input type="checkbox"/> NA	TIME OF RDWY. CLEAR 0255 <input type="checkbox"/> NA	INVEST. AT SCENE <input checked="" type="checkbox"/> Yes <input type="checkbox"/> No

- b. Use an "X" in all cases where a mark is required. A checkmark (✓) is not acceptable.
- c. If a field on the crash report does not apply (not applicable), mark the "NA" box when available or neatly enter "NA" in the section. If the information for a field on the crash report is not known, mark the "Unknown" box when available or enter "UNK" or "Unknown." Every field on the report must have a response.

7 — DRIVERS, VEHICLES, OWNERS, & OCCUPANTS															
NO. 7A. DRIVER — NAME (Last, First, MI) & ADDRESS (Street, City, State, Zip)											PHONE NUMBER				
1 Doe, John E, 1515 North Morgan Drive, Jefferson City, MO 65201											(573) 222-5555				
DRIVER LICENSE / ID NUMBER		STATE		LIC STATUS			LIC TYPE			ENDORSEMENTS					
None		NA		<input type="checkbox"/> Valid <input checked="" type="checkbox"/> NA <input type="checkbox"/> Susp / Rev / Denied <input type="checkbox"/> Expired <input type="checkbox"/> Disqual CDL <input type="checkbox"/> Unknown			<input type="checkbox"/> Operator Class <input type="checkbox"/> CDL Class <input type="checkbox"/> Interm / Grad <input type="checkbox"/> Permit <input type="checkbox"/> MC Only <input checked="" type="checkbox"/> Unlicensed <input type="checkbox"/> Unknown (Explain)			<input type="checkbox"/> Yes (add code) <input checked="" type="checkbox"/> No <input checked="" type="checkbox"/> NA <input type="checkbox"/> Unk					
DATE OF BIRTH	SEX	SEAT LOC	INJ	TRANS-PORT	EJEC-TION	AIR BAG	SAFETY DEVICES	INDICATION OF IMPROPER USE?	VISION OBSTRUCTED	<input checked="" type="checkbox"/> Not Obstructed	<input type="checkbox"/> Trees / Brush	<input type="checkbox"/> Sign	<input type="checkbox"/> Moving Veh	<input type="checkbox"/> Other (Explain)	
01/01/1965	M	FL	2	2	1	5 6 7	2	<input type="checkbox"/> Yes <input checked="" type="checkbox"/> No <input type="checkbox"/> Unk <input checked="" type="checkbox"/> NA	<input type="checkbox"/> NA <input type="checkbox"/> Windshield <input type="checkbox"/> Load on Veh	<input type="checkbox"/> Building <input type="checkbox"/> Embankment <input type="checkbox"/> Parked Veh	<input type="checkbox"/> Hillcrest <input type="checkbox"/> Glare	<input type="checkbox"/> Stopped Veh <input type="checkbox"/> Unknown (Explain)			
DRIVER LICENSE RESTRICTIONS Alcohol Interlock Required on License? <input type="checkbox"/> Yes <input checked="" type="checkbox"/> No <input type="checkbox"/> Unknown <input type="checkbox"/> NA Alcohol Interlock Present? <input type="checkbox"/> Yes <input checked="" type="checkbox"/> No <input type="checkbox"/> Unknown <input type="checkbox"/> NA															
PROOF OF INSURANCE		INSURANCE COMPANY						PHONE NO. (Optional)		POLICY NUMBER		<input type="checkbox"/> NA		<input type="checkbox"/> Driver	
<input checked="" type="checkbox"/> Yes <input type="checkbox"/> No <input type="checkbox"/> Not Required		ABC Insurance Company						(573) 555-1212		L4528-986-77-5489				<input checked="" type="checkbox"/> Vehicle	

When completing the short form version, the "NA" or "UNK" response is necessary only in those fields required on the short form.

d. **PAGE NOT USED** block –This block generally used for hard copy crash reports submitted to MOCARS and is located at the top of two pages on the report, including the second page with *Section 7 - Drivers, Vehicles, Owners, & Occupants*, and the *Narrative / Statements Continuation* page. When these page(s) are not utilized, mark the block "Page Not Used." The page(s) should be counted sequentially as part of the report; however, "NA" should not be entered in the fields.

e. Periods should not be used in any fields except for the following:

i. Section 2

1. GPS Coordinates
2. Distance From (Miles)
3. Intersecting field when entering Emergency Reference Marker number
4. Geo-Code

ii. Section 7G

1. Hazardous Materials Class

iii. Section 9 - *Narrative / Statements*

iv. Train Supplement

1. Distance From Sign to Nearest Rail
2. DOT / AAR Crossing ID. No.

f. Indicate all dates and times on the report form as follows:

i. Date: Month-Day-Year (Example: January 3, 2024, should be shown as 01-03-2024). Note: All year entries must be four characters, i.e., 2024.

ii. Time: Records as 24-hour clock (military time). Example: Show one-thirty in the afternoon (1:30 p.m.) as 1330 hours. (See [page 28](#) for a [conversion chart](#)).

g. Continuation / Supplement Forms

All continuation and supplement forms must be submitted to MOCARS.

i. Continuation

A continuation form provided by MOCARS should be used when sufficient space is not available and is part of the original report. It is not necessary to repeat information; however, the report / case / incident number is required on every page of the report.

ii. Supplement

A supplement form provided by MOCARS should be used to report additional information not included in the original report. All header fields must be completed.

iii. Railway Vehicle Continuation / Supplement

When a [railway vehicle](#) is involved in a reportable crash, record applicable information (railway vehicle, track owner, signals, etc.) on the *Railway Vehicle Continuation / Supplement* form.

- h. All crash reports must be submitted to MOCARS within **10 days** after the initial investigation. It is imperative that fatal crashes be reported immediately to the Missouri State Highway Patrol, Patrol Records Division, via MULES, followed by the completed crash report as soon as possible.
- i. Upon learning of a [late death](#), the department submitting the report will notify the Patrol Records Division via MULES and submit an updated crash report or supplement. Late death reporting will include the date, time, and location of death. (Example: John Doe died on May 26, 2024, at 1411 hours at St. Mary's Hospital, Jefferson City, MO).
- j. Direct any problems with interpretation of this manual or the crash report form to the Missouri State Highway Patrol, Patrol Records Division, Post Office Box 568, Jefferson City, Missouri, 65102, telephone number 573-526-6113. Questions will be resolved at this level in order to ensure uniformity and consistency. Paper/hard copies of the Missouri Uniform Crash Report should also be submitted to the aforesaid address.

### III. Collision Diagramming

- a. Each agency will determine the method of collision diagramming used, e.g., the Institute of Transportation Engineers (ITE) symbols, template drawings, computer generated drawings, or any combination. See [Appendix B, page 150](#), for diagramming methods.
- b. A collision diagram **MUST** be included on all reports where enough evidence and/or facts can be obtained to adequately depict the crash scene. If a diagram is not made, write "None" in [Section 6 - Collision Diagram](#) and fully describe the crash in [Section 9 - Narrative / Statements](#). *All vehicles and pedestrians should be labeled accordingly. (Example: V1, V2, VA, VB, P1, P2, etc.).*
- c. A diagram is not necessary on the original report if a reconstruction report containing a crash diagram is submitted to MOCARS; however, a note (See reconstruction diagram.) should be made in [Section 6 - Collision Diagram](#). The original report / case / incident number must be included on the reconstruction report.

### IV. Photos Taken / Video Taken / Reconstruction

Each agency will determine use of these fields on the report form. They are strictly optional; the information will not be entered in MOCARS.

## GLOSSARY OF GENERAL TERMS AND DEFINITIONS

The *Manual on Classification of Motor Vehicle Traffic Crashes*, approved by the American National Standards Institute (ANSI D.16-2017), and the 5<sup>th</sup> Edition of the *Model Minimum Uniform Crash Criteria* (MMUCC) are used to provide a common language for studying and classifying traffic crashes. Much of the information, along with many of the illustrations and photographs in this manual, were derived from these publications.

Please note, the terms "accident" and "crash" may have been used interchangeably and refer to the same type of incident. While use of the term "crash" has become the standard, the term "accident" continues to be used by some entities.

Some basic definitions are listed below:

### A - B - C - D - E - F - G - H - I - J - K - L - M - N - O - P - Q - R - S - T - U - V - W - X - Y - Z

**ACTIVITY AREA** – Located adjacent to actual work area, whether workers and equipment were present or not.

**ADVANCE WARNING AREA** – Located after the first warning sign, but before the work area.

**BICYCLE FACILITY** – Any road, path, or way which is specifically designated as being open to bicycle/pedalcycle travel regardless of whether such facilities are designated for the exclusive use of bicycles/pedalcycles or are to be shared with other transportation modes.

**BICYCLE LANE** – An area adjacent to travel lanes of a [trafficway](#) which has been designated for preferential or exclusive use by [pedalcyclists](#) through striping, signage or pavement markings. It also includes a portion of roadway that has been designated by striping, pavement markings, or signs for preferential or exclusive use by pedalcyclists.

**BRIDGE PARAPET** – A low wall, which runs along the outermost edge of the roadway or sidewalk on the bridge, usually composed of brick, stone, or concrete.

**BUS** – A [motor vehicle](#) with seating for transporting nine or more persons, including the [driver](#), excluding [limousines](#). A small bus has seating for nine to fifteen persons, including the driver. A large bus has seating for sixteen or more persons, including the driver.

**CARGO** – Items (load) being carried on or in a [motor vehicle](#) or its trailing unit. Cargo is considered part of the vehicle as long as it is in or on the vehicle or has become dislodged from the vehicle but remains in motion. Dislodged cargo becomes an object(s), disassociated with any vehicle, once it comes to a complete stop. People in or on the vehicle are never considered cargo.

**CATAclysm** – A natural occurrence ("Act of God"). When a crash is due directly to a cataclysm, a crash has not occurred. However, if a crash occurs after a cataclysm has stopped, a crash has occurred. The following are typical definitions of cataclysms:

- **Avalanche** – A mass of snow, rock, and/or ice falling down a mountain or incline. (Source: National Weather Service).
- **Cloudburst** – An extreme rainfall sometimes mixed with hail and thunder, which normally lasts no longer than a few minutes, but is capable of creating minor flooding conditions.
- **Cyclone** – A large-scale circulation of winds around a central region of low atmospheric pressure, counterclockwise in the Northern Hemisphere. (Source: National Weather Service.) The winds must be 74 mph or greater to qualify as a cataclysm.
- **Downburst** – A strong downdraft current of air from a cumulonimbus cloud and often associated with intense thunderstorms. Downdrafts may produce damaging winds at the surface. The winds must be 74 mph or greater to qualify as a cataclysm.
- **Earthquake** – Shock waves detectable and sometimes causing violent tremors at the earth's surface, generally originating by movements along deep-seated fault planes.
- **Flood** – The inundation of a normally dry area caused by an increased water level in an established watercourse, such as a river, stream, or drainage ditch. A flash flood is caused by heavy or excessive rainfall in a short period of time, generally less than six hours. Also, at times a dam failure

can cause a flash flood, depending on the type of dam and time period during which the break occurs. (Source: National Weather Service).

- Hurricane – A tropical cyclone with surface winds in excess of 74 mph in the Western Hemisphere. (Source: National Weather Service).
- Landslide / Mudslide – Fast moving soil, rocks, and water that flow down hills, mountain slopes, and canyons. (Source: National Weather Service).
- Lightning – A visible electrical discharge produced by a thunderstorm. The discharge may occur within or between clouds, between the cloud and air, between a cloud and the ground, or between the ground and a cloud. (Source: National Weather Service).
- Tornado – A violently rotating column of air, usually pendant to a cumulonimbus cloud, with circulation reaching the ground. It nearly always starts as a funnel cloud and may be accompanied by a loud roaring noise. On a local scale, it is the most destructive of all atmospheric phenomena.
- Torrential Rain – Very heavy rain, downpours produced by a torrent. Oftentimes with raindrops of greater than 1/5" in diameter.
- Volcanic Eruption – Formed by the partial melting of existing rock and dissolved gases; the liberation of this gas and magma under considerable pressure is considered an eruption. Products of the volcanic eruption include lava flows, pyroclastic materials (volcanic glass), volcanic dust / ash, and gases.

Includes (but is not limited to):

- Any wind above the minimum speed associated with a category one hurricane (75 mph or more).
- **Damage** produced by very large hail.

Examples:

- A **motor vehicle in transport** is struck by lightning causing **damage** to the vehicle.
- A tornado, or winds in excess of 74mph, forces a tree over onto a motor vehicle in transport.
- A motor vehicle in transport is washed off a bridge during a flood.
- A landslide pushes a motor vehicle in transport off the **roadway** causing the vehicle to overturn.
- A motor vehicle sustains **damage** from very large rain drops during torrential rain.
- A motor vehicle in transport suffers **damage** from golf ball sized hail during a tornado.

Excludes:

- Natural events not listed above.

Examples:

- Rain, snow, fog, small hail, ice, smog, etc.
- Winds below the minimum speed associated with a category one hurricane (74 mph or less).
- A few small falling rocks not associated with a landslide or avalanche.
- An old tree falling only due to a rotting root system.
- Shallow standing water.

Crash Examples:

- A **motor vehicle** is driven into a river or creek after a bridge was washed out by a flood, and the flood has ended. The cataclysm has stopped; therefore, this would be a traffic crash.
- An earthquake buckled a road. After the earthquake stopped, a motor vehicle came along and crashed into the buckled roadway.
- A tree branch from a rotten tree, or a tree with a deteriorated root structure, falls across several motor vehicles in transport as a result of winds below 75 mph.
- A 25 mph wind propels a trash can from a city sidewalk into a passing motor vehicle.
- Power lines or an overhead traffic signal falling on a motor vehicle in transport.

**CHAIN REACTION CRASH** – When, in the same area in time and space, several **motor vehicles** are involved in a chain of events and the investigator is unable to determine whether there has been a **stabilized situation**, the chain of events should be considered a single crash.

**COMMERCIAL CARRIER** – A person, firm, corporation who is the current lessee, renter, or lawful user of the commercial motor vehicle at the time of the crash. Refer to **Appendix D** on **page 156** for instructions on how to properly identify the carrier.

**COMMERCIAL MOTOR VEHICLE** – Any motor vehicle meeting one or more of the following criteria:

1. having a hazardous materials placard; or
2. a truck / cargo van with a [GVWR](#) / [GCVWR](#) of more than 10,000 lbs.; or
3. having a seating capacity of 9 or more people including the driver.

**CONSTRUCTION ZONE** – See “[Work Zone](#).”

**CRASH** – See “[Motor Vehicle Traffic Crash](#).”

**CROSSING ISLAND** – A concrete, asphalt, or grassy area in the [trafficway](#) used by [pedestrians](#) when crossing the roadway.

**DAMAGE** – Harm to property that reduces the monetary value of that property.

Includes (but is not limited to):

- Harm to domestic animals that have monetary value.
- Fire starting in a [motor vehicle in transport](#).
- Damage from an animal flying against or into a motor vehicle in transport.
- An object falling on a motor vehicle in transport.

Excludes (but is not limited to):

- Harm to animals that have no monetary value where no other [property damage](#) or [injury](#) occurs.
- Mechanical failure during normal operation, such as a tire blowout, broken fan belt, or broken axle where no other property damage or injury occurs.

**DELIBERATE INTENT** – The classification used when a person acts deliberately to cause an event. Such intended events are excluded from motor vehicle crash classification.

Includes:

- Suicide
- Self-inflicted [injury](#)
- Homicide
- Injury or damage purposely inflicted
- [Legal intervention](#)

Excludes:

- Injury or damage beyond that which was intended.

**Note:** A [motor vehicle](#) that intentionally rams another motor vehicle causing [injury](#) and/or [property damage](#) is not a motor vehicle crash; however, a crash report may be completed and attached as a supplement to a criminal investigation report. If the event involves a fatality, the incident and/or crash report should be submitted to the MOCARS.

Examples:

- If the [motor vehicle](#) that was struck in the “Note” above loses control and collides with another motor vehicle resulting in further [property damage](#) and/or [injury](#), then a motor vehicle crash has occurred. A two-vehicle crash report should be submitted listing the vehicle that caused the first intentional event as Vehicle A, and the other two vehicles as Vehicles 1 and 2.
- A [driver](#) intentionally kills or injures himself with a motor vehicle by driving it against a fixed object or into a body of water, the driver’s death or injury is a result of deliberate intent.
- A driver intentionally kills or injures another person with a [motor vehicle](#) by running into a [pedestrian](#), the death or [injury](#) is a result of deliberate intent.
- A [driver](#) intentionally kills or injures himself with a motor vehicle by driving it against a [fixed object](#) and debris from the impact strikes a [pedestrian](#) causing serious physical injury. The injury and [damage](#) from the impact with the fixed object would be deliberate intent; however, the injury to the pedestrian goes beyond that which was intended and would be a motor vehicle crash.

**DISABLING DAMAGE** – [Damage](#) which precludes departure of the [motor vehicle](#) from the scene of the crash in its usual daylight-operating manner after simple repairs.

Inclusions:

- Damage to motor vehicles that could have been driven, but would have been further damage if so driven.

Exclusions:

- Damage which can be remedied temporarily at the scene without special tools or parts.
- Tire disablement without other damage even if no spare tire is available.
- Headlamp or taillight damage.
- Damage to turn signals, horn, or windshield wipers which makes them inoperative.

**DRIVER** – An [occupant](#) who in actual physical control of a vehicle or, for an out-of-control vehicle, an occupant who was in control until control was lost.

**DRIVEWAY** – A private way that provides vehicular access to the public from a [trafficway](#) to property, parking, or loading areas outside the boundaries of the trafficway, but is considered to be not open to the public for transportation purposes as a trafficway.

Includes (but is not limited to):

- A private drive providing access to a residence, businesses, and other private entities not open to the public for transportation purposes.

Excludes:

- Privately constructed and/or maintained roads open to the public for moving persons or property from one place to another.
- [Parking lots](#)
- Entrances to businesses and other entities open to the public for transportation purposes.
- Driveway access

**DRIVEWAY ACCESS** – A driveway access is a portion of the [trafficway](#) at the end of a driveway providing access to property adjacent to a trafficway. A driveway access is not considered an intersection. See [Appendix E](#), *page 199*.

Includes (but is not limited to):

- Entrance to a private residence.
- Entrances to gas stations.
- Sidewalks that cross over a driveway access.
- Entrance to a [parking lot](#).

Excludes:

- Entrances, sidewalks, etc. not within the boundaries of a trafficway.

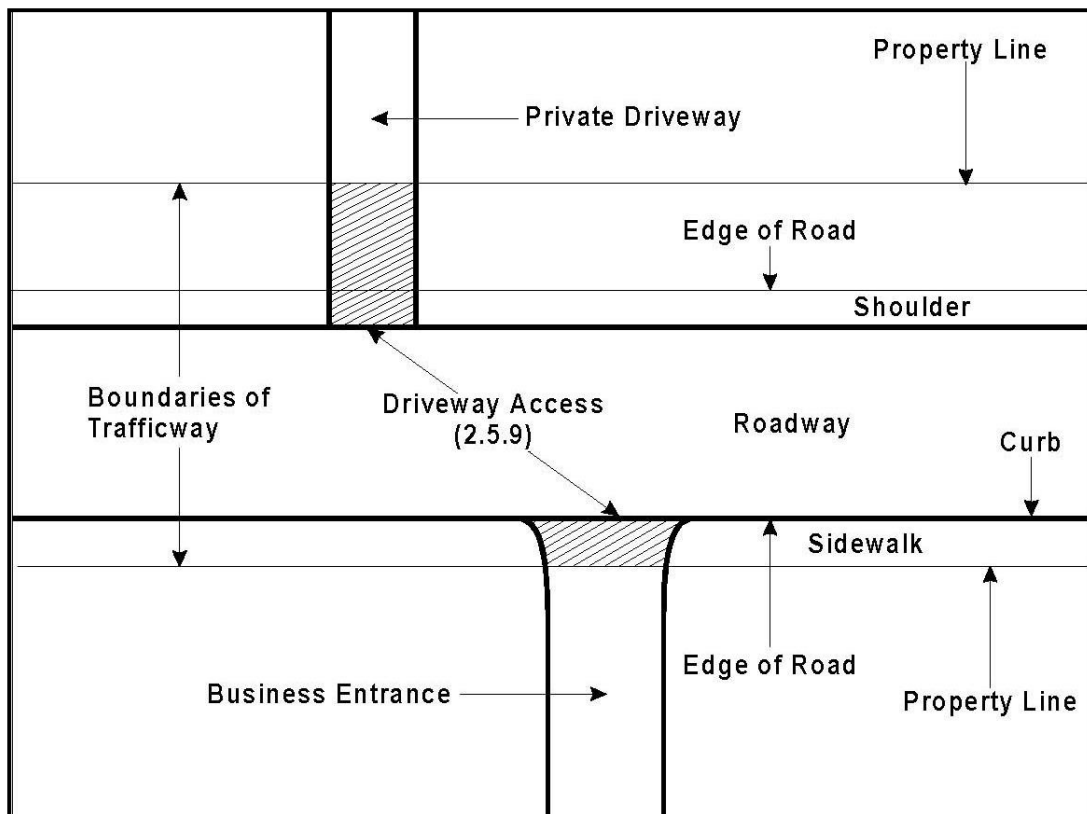

(Source: ANSI D.16 - 2017 Manual on Classification of Motor Vehicle Crashes, 8<sup>th</sup> Edition).

**EMERGENCY REFERENCE MARKER (ERM)** – ERMs are located statewide on most interstate highways and are normally spaced 0.2 mile apart. ERMs provide the direction of travel, interstate route, milepost, and tenth of a mile location. When used, crashes should be located to the nearest ERM, which should be 528 feet (0.1 mile) or less from the crash scene. See [photographs](#) on [page 46](#).

The only exception to this distance would be in the case of a missing ERM. Missing ERM locations should not be used, rather the nearest ERM that is not missing may be used (which may be farther than 528 feet away) or the nearest roadway or bridge as listed in the [MoDOT Interactive Mapping Tool](#).

**Note:** The abbreviation “ERM” must be used as a route designation when using an emergency reference marker as the “*Intersecting*” street, etc. in [Section 2 – Location](#) of the crash report. Emergency reference markers cannot be used in the “*On*” subsection to locate crashes.

**FIRST HARMFUL EVENT** – The first [injury](#), death, or [damage](#)-producing event.

**FIXED OBJECT** – A fixed object is any object not in motion and attached to, or part of, the terrain.

Includes (but is not limited to):

- Any object attached to or a part of the terrain.
- Tree/ stump (standing), embankment / [driveway](#) / ground / rock bluff, guardrail face, utility pole, fence, street light support, culvert, highway traffic sign post / support, bridge pier / abutment / support, curb, mailbox, concrete traffic barrier, building, traffic signal support, [impact attenuator / crash cushion](#), fire hydrant, [bridge parapet](#) end, bridge rail, guardrail end, [median](#) / other traffic barrier, overhead sign support, ditch, other posts / poles / supports, wall, cable barrier, bridge overhead structure, [work zone](#) / maintenance equipment, or overhead line / cable. Refer to [Section 8 - Codes](#) on [page 123](#) for a description of each of these objects.

**GCVWR (Gross Combined Vehicle Weight Rating)** – The combined weight ratings specified by the manufacturer for each truck and its trailing unit(s); this is not the licensed weight.



**GVWR (Gross Vehicle Weight Rating)** – The weight rating specified by the manufacturer for the vehicle; this is not the licensed weight.

**HARMFUL EVENT** – An occurrence resulting in [property damage](#), [injury](#), or death.

**IMPACT ATTENUATOR / CRASH CUSHION** – A device for controlling the absorption of energy released during a vehicle collision (“crash cushions”). Its most common application involves protection of fixed roadside objects such as bridge piers, elevated gores at exit ramps, etc. Examples include, but are not limited to, barrels filled with water or sand, plastic collapsible structures, collapsible guard rail ends, etc. See [photographs](#) on [page 126](#).

**IN COMMERCE** – Any instance when the [driver](#), vehicle owner, and/or [carrier](#) is involved in trade, traffic, or transportation of commodities or persons for financial consideration or exchange, or in the furtherance of a business enterprise. “In commerce” is no longer a factor to consider when determining whether to complete the [Section 7H – Commercial Motor Vehicle](#) section of the report.

**INJURY** – An injury is bodily harm to a person and includes fatal injury.

Includes (but is not limited to):

- Accidental poisoning from carbon monoxide generated by a [motor vehicle in transport](#).
- Breakage of a part on a motor vehicle in transport resulting in injury.
- An object unintentionally thrown towards a motor vehicle resulting in injury to the [driver](#) or [occupant](#).

Excludes:

- Injury due to a fight between occupants in a motor vehicle in transport.
- Self-inflicted injury.
- Effects of disease such as stroke, heart attack, etc.

**INTERSECTION** – An intersection consists of two or more [roadways](#) that intersect at the same level. It is an area which 1) contains a crossing or connection of two or more roadways not classified as [driveway access](#) and 2) is enclosed within the prolongation of the lateral curb lines or, if none, the lateral boundary lines of the roadways. Where the distance along a roadway between two areas meeting these criteria is less than 33 feet, the two areas and the roadway connecting them are considered to be parts of a single intersection. See [Appendix E, page 167](#) for examples.

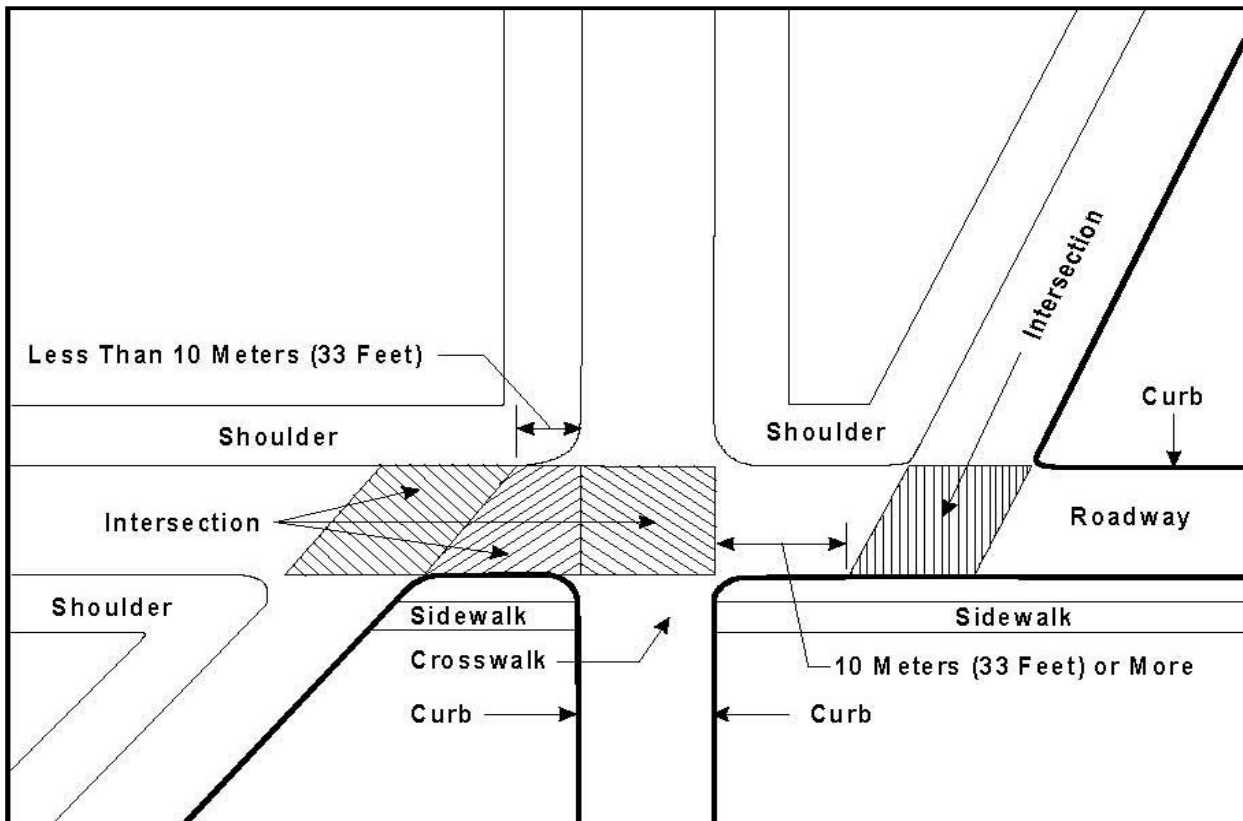

(Source: ANSI D.16 - 2017 Manual on Classification of Motor Vehicle Crashes, 8<sup>th</sup> Edition).

**INTRASTATE COMMERCE** – Commerce in any state where the transit between the points of origin and termination occurs entirely within the borders of the state of origin.

**INTERSTATE COMMERCE** – Commerce in the United States where the transit between the points of origin and termination does not occur entirely within the borders of the state of origin.

**IN TRANSPORT** – In regard to [motor vehicles](#), in-transport is the state or condition of a vehicle on a [roadway](#) or in motion within or outside the [trafficway](#). **A working motor vehicle is not considered to be “in-transport.”**

In roadway lanes used for travel during some periods and for parking during other periods, a [parked motor vehicle](#) should be considered to be in-transport during periods when parking is forbidden.

Includes (but is not limited to):

- [Motor vehicle](#) in traffic on a [roadway](#).
- Driverless motor vehicle in motion.
- Motionless, disabled, or abandoned motor vehicle on a roadway.
- Motor vehicle in motion outside the [trafficway](#).
- A stopped (not legally parked) motor vehicle with any portion of its primary outline as defined by the four sides of the vehicle (e.g., tires, bumpers, fenders) and load, if any, within the roadway.

Examples:

- A stopped motor vehicle partially on the [shoulder](#) with two tires on the roadway.
- A tractor trailer parked on the shoulder with its load hanging over the roadway edge line.
- A police vehicle patrolling or responding to an emergency.
- A police or emergency [motor vehicle](#) stopped on the [roadway](#) at the scene of a crash, traffic stop, or other police action, regardless of whether or not the emergency lights have been activated.
- Construction, maintenance, or utility work vehicles traveling on a [trafficway](#) from one work site to another location.
- Taxis, [limousines](#), or other passenger vehicles, with or without passengers, while on the roadway (not parked) or in-motion on a trafficway.
- A [school bus](#) stopped in a travel lane with signs and/or lights activated.

- A moving motor vehicle on a private [driveway](#).
- An ATV driving on a recreational trail inside or outside the trafficway.
- A motor vehicle (not a [working motor vehicle](#)) operating in the closed portion of the trafficway.
- A van left unattended in a lane during rush hour when parking is prohibited because it is in an open travel lane at that time.
- A tow truck on a [roadway](#) engaged in winching a vehicle from the ditch on a [trafficway](#).
- A garbage truck stopped on the roadway being loaded with trash.
- A riding motorized lawn mower, under its own power, being driven from one home to another upon a city street.
- A tractor hauling a trailer load of corn from a farm field to a storage facility.

Excludes:

- [Motor vehicle](#) legally stopped or parked off the [roadway](#), but within the [trafficway](#).
- Motor vehicle stopped / parked in a parking lane or on a roadway during a period when parking is allowed.
- Transport vehicle performing construction, maintenance, or utility work on a trafficway.
- A stopped (legally parked) motor vehicle with any portion of its primary outline as defined by the four sides of the vehicle (e.g., tires, bumpers, fenders) and load, if any, not within the roadway.

Examples:

- A disabled [motor vehicle](#) legally stopped / parked on the [shoulder](#), [median](#), or [roadside](#).
- An automobile parked in an area designated for parking against the curb of a residential street, or in a parking space / lane.
- A truck stopped on the shoulder where only the extended side-view mirror overhangs the [roadway](#) edge line.
- A paint striping highway truck in the act of painting the lines on a roadway.
- A concrete mixer discharging its load of concrete on a [trafficway](#).
- A snowplow removing snow from an interstate highway.

**LATE DEATH** – Any death occurring on a date other than the date of the crash, within 30 days, which is a result of an [injury](#) sustained from the crash.

**LEFT THE SCENE** – Leaving the scene of a motor vehicle crash consist of being the operator or [driver](#) of a vehicle on the highway or any publicly or privately owned parking lot or parking facility generally open for use by the public, and knowing that an injury has been caused to a person or damage has been caused to property, due to his or her culpability or to crash, he or she leaves the place of the injury, damage, or crash without stopping and giving his or her name, residence, including city and street number, motor vehicle number, and operator's license number, if any, to the injured party or to a police officer, or if no police officer is in the vicinity, to the nearest police station or judicial officer.

**Note:** Vehicles moved from final resting position to an area in close proximity to the crash scene for safety reasons did not leave the scene.

**LEGAL INTERVENTION** – A category of [deliberate intent](#) in which [injury](#) or [damage](#) is caused during an attempt to apprehend a law violator by a law-enforcing agent / officer. If in doing such intended acts, other [injury](#) or [damage](#) occurs that goes beyond the original intent, these events are unintentional and meet the specifications of a motor vehicle crash unless the contrary can clearly be established. Remember, the law enforcement officer must intend for the act to occur.

Legal Intervention Examples:

- A roadblock is set up or other devices deployed to stop a lawbreaker, and the lawbreaker crashes their motor vehicle into it either intentionally or unintentionally.
- A police car cuts in front of a car to force the car to the curb or shoulder and, as a result, the two cars collide.
- A lawbreaker loses control of their motor vehicle and crashes as a result of bullets fired into it from a police officer's gun.

Crash Examples:

- If a driver/vehicle other than the lawbreaker crashes unintentionally into a police road block or devices deployed to stop the lawbreaker, the crash is not considered to be a result of legal intervention.
- A lawbreaker, while eluding police, loses control of their motor vehicle and crashes into another motor vehicle.

A police car strikes a motor vehicle other than the subject of the pursuit.

**LIMOUSINE** – Any motor vehicle, other than a bus, operating [in commerce](#) having a capacity of 7-15 [occupants](#) (with the [driver](#)).

**LOW SPEED VEHICLE (LSV)** – A [motor vehicle](#) with four or more wheels whose top speed is greater than 20 miles-per-hour, but not greater than 25 miles-per-hour. LSVs are required to be equipped with basic items of safety equipment: headlamps, stop lamps, turn signal lamps, tail lamps, reflex reflectors, parking brake, windshields of either type AS-1 or AS-5 glazing, rearview mirrors, seat belts, and vehicle identification numbers (VINs).

Includes (but is not limited to):

- A conventional golf cart that was modified, after its original manufacture, so as to increase its top speed to the 20-25 mph range.
- An originally manufactured custom golf cart (that is not a modified conventional golf cart) that has a top speed of 20 to 25 mph.

Examples:

- Neighborhood Electric Vehicle (NEV)
- Fleet golf carts sold to golf courses that have been speed-modified to increase their top speed into the 20-25 mph range.
- Personal golf carts sold to individual persons that have been speed-modified or originally manufactured to achieve a top speed of 20 to 25 mph.
- Other low speed motor vehicle designed for transport on local streets.

Excludes:

- Conventional golf cart not modified or originally custom manufactured to achieve top speeds above 20 mph.
- Automobile
- Any [personal conveyance](#).
- Any size slow moving farm tractor / equipment.

Examples:

- A golf cart used solely to carry one or more people and golf equipment to play golf, sold to golf courses.
- A golf cart used to carry one or more people and may carry golf equipment to play golf, sold to individual persons who may use them to travel on trafficways to and from golf courses and to play golf, to travel on trafficways for purposes unrelated to golf, or for all of these purposes.
- A golf cart that has been speed-modified after its manufacture or originally custom manufactured to achieve top speeds greater than 25 mph.
- Motorized wheelchair
- Motorized skateboard
- Motorized handicapped scooter
- [Personal conveyances](#) such as a Segway.

**MEDIAN** – An area of [trafficway](#) between parallel [roads](#) separating travel in opposite directions. Flush or painted medians should be 4 or more feet wide between inside roadway edge lines. Medians fewer than 4 feet wide shall have a barrier to be considered a median. Flush or painted medians or raised areas between roads with travel in opposite directions less than four feet wide should be considered the center of the [road](#). Continuous left turn lanes are not considered painted medians. See [diagram](#) on [page 25](#).

Includes (but is not limited to):

- Physical barrier separating roads with travel in opposite directions (i.e., concrete traffic barrier, cable barrier, etc.).

- Depressed, raised, or flush area between roads with travel in opposite directions (i.e., grassy area, etc.).
- Painted median of four or more feet wide between roads with travel in opposite direction (i.e., a flushed painted median of 4 or more feet, etc.).

Excludes:

- [Shoulder](#)
- Turn lane
- Continuous left-turn lane

**MOTOR CARRIER** –The legal business entity, individual, partnership, corporation, or organization that directs, controls, and is responsible for the transportation of goods, property, or people. See [Commercial Carrier](#) on *page 11*.

**MOTOR VEHICLE** – Any motorized (mechanically or electrically powered) device used to move persons and/or property along with the device itself from one place to another and is not operated on rails, operated within the confines of a building, aircraft or watercraft, a [personal conveyance](#), or a weapon. The load/[cargo](#) or [occupants](#) upon or in the motor vehicle, or a device being towed by the motor vehicle, are considered part of the motor vehicle.

Includes (but is not limited to):

- Any object being towed by the motor vehicle.
- Any devices detached from the motor vehicle while in motion.
- Any devices set in motion by a motor vehicle such as during pushing.
- The load or occupants upon or in the motor vehicle, or upon or in the device being towed or pushed. Could include persons boarding or alighting from the vehicle.
- Electrically powered buses attached to cables.
- Trolleys on highway tires.
- [Low speed vehicles](#) such as golf carts.
- Motor-driven cycles such as mopeds and miniature motorcycles (pocket bikes).
- Movable devices such as construction, agricultural, industrial, residential equipment, etc. not designed primarily for moving persons or property for transportation purposes, but being used at the time outside the confines of a building for moving persons, property, or the device itself from one place to another (i.e., transportation purposes).

Examples:

- A tow truck using its winch to pull a vehicle out of a ditch.
- Electric or telephone company truck with a “cherry picker” repairing cables on a utility pole off the [trafficway](#).
- A road grader going from one work site to another.
- Garbage truck being loaded with trash.
- A riding motorized lawn mower, under its own power, being driven from one home to another upon a city street.

Excludes:

- Devices operated on rails.
- Devices operated within the confines of a building.
- Motorized [personal conveyances](#).
- Movable devices such as construction, agricultural, industrial, residential equipment, etc. being used at the time within the confines of a building or **not** being used for moving persons, property, or the device itself from one place to another (i.e., transportation purposes).
- Aircraft
- Watercraft

Examples:

- Motorized skateboard
- Motorized toy car
- Motorized wheelchairs or handicapped devices
- Segway-style devices

- Forklift operated within the confines of a building.
- Riding motorized lawn mower mowing a residential lawn off the [trafficway](#).

**MOTOR VEHICLE IN TRANSPORT** – The state or condition of a [motor vehicle](#) when it is being used for moving persons or property (including the vehicle itself) from one place to another, and is:

1. In motion; or
2. On a roadway, but not parked in a designated area.

Examples: [Motor vehicle](#) in traffic on a highway; driverless motor vehicle in motion; motionless motor vehicle abandoned on a roadway; disabled motor vehicle on a roadway; etc. In [roadway](#) lanes used for travel during rush hours and parking during off-peak hours, a [parked motor vehicle](#) is [in transport](#) during periods when parking is forbidden.

**MOTOR VEHICLE TRAFFIC CRASH** – Any motor vehicle crash in which the [unstabilized situation](#) originates on a [trafficway](#) or a [harmful event](#) occurs on a trafficway. If an unstabilized set of events originates and terminates off a trafficway and no harmful event occurs on a trafficway, the event is a motor vehicle crash but not a motor vehicle traffic crash. Both motor vehicle crashes and motor vehicle traffic crashes are included in MOCARS; however, MOCARS statistics only include motor vehicle traffic crashes.

To have a motor vehicle crash, the following elements must be present:

1. Involvement of at least one [motor vehicle in transport](#).
2. At least one [harmful event](#).
3. The harmful event must be the result of an unintentional act.
4. The harmful event is not the direct result of a [cataclysm](#).
5. The crash was not initiated by an action of an aircraft or watercraft.
6. The crash does not include any [harmful event](#) involving a [railway vehicle](#) in transport prior to involvement of a [motor vehicle in transport](#).

**Note:** If there is an intentional act with a [motor vehicle](#) resulting in a fatality, a motor vehicle crash report may be completed as a supplement to the investigative / incident report. In these instances, a copy of the crash and/or incident report should be submitted to the Missouri State Highway Patrol, Patrol Records Division, for review.

A collision involving a wild animal, i.e., having no monetary value, where no other [damage](#) is sustained is not a motor vehicle crash. Conversely, a collision involving a domestic animal with monetary value would be a motor vehicle crash regardless of any other damage sustained.

**MOTORCYCLE** - Any [motor vehicle](#) having a seat or saddle for the use of its operator and traditionally designed to travel on not more than three wheels in contact with the ground. Non-traditional designs exist with more than three wheels and these may be considered a motorcycle. See [examples](#), [page 79](#).

**NONCONTACT VEHICLE** – A noncontact [vehicle](#) is one in which the vehicle contributes to a crash without contact. A noncontact vehicle indirectly involved in a crash should not be counted as one of the vehicles involved and should not be listed in [Section 7](#) - Drivers, Vehicles, Owners, & Occupants. The involvement of noncontact vehicles should be explained in the narrative and identified as "Vehicle A," "Vehicle B," etc., [Section 6 - Collision Diagram](#) and [Section 9 - Narrative / Statements](#).

Examples:

- A [motor vehicle](#) changes lanes into the path of another motor vehicle (without making contact) causing a crash. The vehicle changing lanes is a noncontact vehicle.
- A motor vehicle exiting a private drive fails to yield to an oncoming vehicle on a city street. In an attempt to avoid a collision, the oncoming vehicle skids off the roadway and collides with a utility pole. The vehicle exiting the private drive is a noncontact vehicle.

**NON-MOTORIST** – Any person who is not an [occupant](#) of a [vehicle](#). This includes [pedestrians](#), bicyclists/[pedalcyclists](#), and occupants of other transport devices.

**NUMBER OF VEHICLES INVOLVED IN A CRASH** –The number of [motor vehicles](#) as well as [railway vehicles](#) directly involved in a motor vehicle crash before the situation [stabilizes](#). [Working motor vehicles](#) are included

when engaged in a harmful event with a separate motor vehicle **"in transport"** during the unstabilized event(s). Any subsequent contact after the situation stabilizes constitutes a separate crash.

Additionally, an object set in motion by a motor vehicle or railway vehicle is considered an extension of the vehicle and will be treated as such. EXAMPLE: An object falls from or is set in motion by a moving motor vehicle causing damage to a second or multiple motor vehicles before the object comes to rest and stabilizes. Record this as a two-vehicle crash or a multiple vehicle crash. Considering the first harmful event is a collision with the object that fell from or was set in motion by a moving vehicle, record the "crash type" as **"Struck By Falling, Shifting Cargo or Anything Set in Motion by Motor Vehicle."** **Note:** A motor vehicle is not considered an "object" for the purposes of this definition and, consequently, is not considered an extension of the striking vehicle. A motor vehicle put in motion when struck by a **motor vehicle in transport** or **other transport device** is considered a vehicle involved in the crash.

When a **motor vehicle** and / or its **driver** contribute to a crash without contact or direct involvement of a harmful event, include them in **Section 6 - Collision Diagram** and **Section 9 - Narrative / Statements**, identifying them as "Vehicle A," "Vehicle B," etc. Do not include these vehicles in the "Number of Vehicles Involved" box.

Motor vehicles involved in the same **unstabilized event**, which sustain **damage** or a **harmful event**, but do not strike each other are both included in the number of vehicles involved in a crash. For example, a westbound motor vehicle goes out of control and an eastbound motor vehicle runs off the road while avoiding the westbound vehicle. The westbound motor vehicle runs off the road and strikes a rock bluff and the eastbound vehicle also runs off the road and strikes an embankment. Neither motor vehicle strikes the other; however, since both vehicles sustained damage (both were involved in a harmful event) during the same unstabilized situation, the event is a single motor vehicle crash involving two motor vehicles.

**OCCUPANT** – Any person who is in or on a **vehicle**. Note: Occupants ejected from a vehicle and hit (prior to stabilization) are still part of the vehicle.

**OPERATOR** – See **"Driver."**

**OTHER NON-MOTORIST** – A person who is an occupant of a mechanically or electrically powered device that is **NOT** a **motor vehicle (in transport or parked)**, **working motor vehicle**, **railway vehicle**, **personal conveyance**, or **pedalcycle**. This would also include occupants of an "other transport device." For further information and **examples**, see **page 35**.

**OTHER TRANSPORT DEVICE** – A device or object other than a **motor vehicle**, **working motor vehicle**, **personal conveyance**, **pedalcycle**, aircraft, watercraft, **railway vehicle**, or weapon. The device or object may or may not be mechanically or electrically powered.

Includes (But not limited to):

- Horse and rider.
- Team of horses harnessed to a conveyance traveling on or off a trafficway.
- Road grader grading a surface off the **trafficway**.
- Riding lawn mower engaged in mowing off the trafficway.
- Farm tractor engaged in planting a field.
- Bulldozer engaged in excavating a construction site off the **trafficway**.

Excludes (But not limited to):

- Devices which do not move from one place to another, such as pipelines, elevators, escalators, ski lifts, conveyor belts systems, etc.
- Weapons such as guns, torpedoes, etc.
- Human-powered, non-motorized devices, such as skis, scooters, roller skates, baby carriages, etc.

**PARKED MOTOR VEHICLE** – A **motor vehicle** not **in-transport**, other than a **working motor vehicle**, that is not in motion and not located on the **roadway**. A "parked motor vehicle" should be considered to be in-transport during periods when parking is prohibited in roadway lanes used for travel during some periods and for parking during other periods. For further information and **examples**, see **page 33**.

**PARKING LOTS** - An area used primarily for parking road vehicles. When paved and marked it commonly includes parking stalls, parking lot aisles, and parking lot ways. See **Appendix E, page 200**, for examples.

**PARKING LOT AISLES** - Areas used primarily for vehicular access to parking stalls. Parking lot aisles are not [trafficways](#). See [Appendix E, page 200](#), for examples.

**PARKING LOT WAY** - Land ways used primarily for vehicle circulation within parking lots and for vehicular access to parking lot aisles. Parking lot ways in parking lots open to the public are [trafficways](#). See [Appendix E, page 200](#), for examples.

**PARKING STALLS** - Areas reserved primarily for parked road vehicles. Parking stalls are not [trafficways](#). See [Appendix E, page 200](#), for examples.

**PEDALCYCLE** – A device operated by pedals such as bicycles, tricycles, unicycles, pedal cars, etc., which can be propelled by human power and/or a motor. Excludes [motorized bicycles / mopeds](#). See [page 29](#) for [more information](#).

**PEDALCYCLIST** – Person who is an occupant of a pedalcycle in transport. Excludes a person standing on their feet next to or pushing a pedalcycle. See [page 30](#) for [more information](#)

**PEDESTRIAN** – Any person who is not an [occupant](#), in or on, a vehicle. Excludes [pedalcyclists](#) and [other non-motorists](#). For further information and [examples](#), see [page 32](#).

**PERSONAL CONVEYANCE** – A device other than a [motor vehicle](#), aircraft, watercraft, [railway vehicle](#), or [pedalcycle](#) used by a pedestrian for personal mobility assistance or recreation. These devices can be motorized or human powered, but not propelled by pedaling.

Includes (but is not limited to):

- Rideable Toys
  - Roller skates, in-line skates
  - Skateboard
  - Toy Car
  - Baby Carriage
  - Scooter
  - Toy Wagon
- Motorized Rideable Toys
  - Motorized Skateboard
  - Motorized Toy Car
- Devices for Personal Mobility Assistance
  - Segway-style Device
  - Motorized and Non-motorized Wheelchair
  - Handicapped Scooter

Excludes:

- Golf Cart
- [Low Speed Vehicle](#) (LSV)
- Go-carts
- Minibike
- "Pocket" Motorcycle
- Motor Scooter
- Moped

**PROPERTY DAMAGE (PDO)** – A crash that results in damage to the [motor vehicle](#) or other property, but without [injury](#) to any [occupants](#) or [non-motorists](#).

**PUBLIC CONVEYANCE** – A [motor vehicle](#), either publicly or privately owned, engaged in the business of passenger transportation services. This includes, but is not limited to, buses, taxis, [limousines](#), and shuttle services with or without passengers at the time of the crash. Private carpooling is not included under this definition.

**RAMP** – An auxiliary [roadway](#) used for entering or leaving through-traffic lanes at interchanges. Ramps will be identified in the [MoDOT Interactive Mapping Tool](#) by a unique number and have a designation of RP.



**Note:** Access to weigh scales (WS) and rest areas (RA) are not ramps.

**RAILWAY VEHICLE** – Any device, with or without coupled cars, designed for transport on a railway. Includes any device designed to operate on railway tracks under its own power, such as a motor vehicle equipped with flange wheels. A non-motorized device, unattached from the power unit, or not set in motion by a power unit, is not a railway vehicle, e.g., boxcar sitting on rails not attached to an engine is an "Other Object."

**REVERSIBLE LANES** – Reversible lanes are those that the direction of travel is reversed at certain designated times.

**ROAD** – That part of a [trafficway](#) including both the roadway and any [shoulder](#) alongside the roadway. See [diagram](#) on *page 25*.

**ROADSIDE** – The outermost part of the trafficway from the property line or other boundary into the edge of the first road. Does not include persons on a sidewalk. See [diagram](#) on *page 25*.

**ROADWAY** – The part of a [trafficway](#) designed, improved, and ordinarily used for vehicular travel. See [diagram](#) on *page 25*.

Note:

- The roadway is the traveled portion of the trafficway.
- An undivided trafficway has one roadway.
- A divided highway or expressway has more than one roadway, one for each direction of travel.
- The [shoulder](#) is not considered a part of the roadway.

**SAFETY DEVICE** – A device used to restrain, protect, and/or identify vehicle [drivers](#) / [occupants](#) and/or [non-motorists](#) to minimize likelihood of [injury](#).

**SCHOOL BUS** – Any [motor vehicle](#) used for transporting school pupils at or below the 12<sup>th</sup> grade level, to or from a public or private school, or school-related activity, or going to pick up or returning from delivering school pupils, and only if it is externally identifiable by the following characteristics:

1. Yellow in color.
2. The words "school bus" on front and rear.
3. Equipped with flashing red lights on front and rear.
4. Lettering on both sides identifying the school or district served, or company operating the bus.

A motor vehicle is NOT a school bus while it is being used to transport non-school pupils, on trips which involve the transportation exclusively of other passengers such as senior citizens or migrant workers, or exclusively for purposes other than the transportation of school pupils.

**SEPARATOR** – The area of a [trafficway](#) between parallel [roads](#) separating travel in the same direction or separating a frontage road (outer road or service road) from other roads. See [diagram](#) on *page 25*.

Includes (but is not limited to):

- Physical barrier separating roads with travel in the same direction (i.e., concrete or cable barrier, etc.).
- Physical barrier separating a frontage road from other roads of a trafficway (i.e., concrete or cable barrier, etc.).
- Depressed, raised, or flush area between roads with travel in the same direction.
- Depressed, raised, or flush area between a frontage road and other roads of a trafficway. This includes areas between a ramp and the roadway the ramp is exiting from or connecting to.

Excludes:

- [Shoulder](#), [Median](#)

**SHARED-USE PATH OR TRAIL** – Bikeway physically separated from [motor vehicle](#) traffic by an open space or barrier. They may also be used by [pedestrians](#), skaters, wheelchair users, joggers, and other non-motorized users. Most have two-way travel.

**SHORT FORM FIELDS** – These fields have captions or borders shaded gray. (See *page 149* for list of [fields](#)).

**SHOULDER** – The part of the [trafficway](#) contiguous with the [roadway](#) which may accommodate stopped motor vehicles, emergency use, or lateral support of the roadway structure. See [diagram](#) on *page 25*.

Note:

- The shoulder is not considered part of the [roadway](#).
- The shoulder and the roadway combine to make up the [road](#).
- The line between the roadway and shoulder may be a painted edge line, a change in surface color or material, or a curb.

**STABILIZED EVENT** – Marks the end of an [unstabilized event](#). This generally occurs when persons and property come to final rest, and nothing further will occur insofar as the event itself is concerned. Another unstabilized event may follow because of subsequent actions closely related to the first event; however, it should be treated as a separate event.

**TRAFFICWAY** – The entire width between property lines, or other boundary lines, of every way or place, other than an airway or waterway, of which any part is open to the public as a matter of right or custom and used for moving persons or property from one place to another. See [diagram](#) on *page 25*.

- Airway - A transport way reserved primarily for use by aircraft taking off, in flight, or landing.
- Waterway - A transport way reserved primarily for use by watercraft.

Includes (but is not limited to):

- Areas within guarded entrances, such as military posts or private residential developments, are trafficways provided the guards customarily admit public traffic.
- Privately constructed and/or maintained roads open to the public for moving persons or property for transportation purposes.
- Local [roads](#) in a residential development open to the public.
- Land way providing vehicular access and/or circulation from a trafficway to a business open to the public.
- [Parking lot ways](#). See example in [Appendix E](#), *page 200*.

Excludes:

- Areas under construction are not a trafficway if traffic is prohibited from entering by signing or barriers, which are in conformance with applicable standards. However, if any part of the trafficway is open to traffic while the remainder is closed, the part that is open is a trafficway. Likewise, any temporary bypass of a construction site is a trafficway.
- A trafficway temporarily closed to travel and marked by signing or barriers, which are in conformance with applicable standards, is not a trafficway even though used by authorized vehicles, such as maintenance vehicles, or when intentionally or inadvertently used by unauthorized vehicles. A trafficway open only to local traffic is **not** considered closed.
- [Roads](#) in a gated community only open to residents and their guests.
- Land ways not open to the public.
- [Parking spaces](#) and [parking aisles](#). See example in [Appendix E](#), *page 200*.

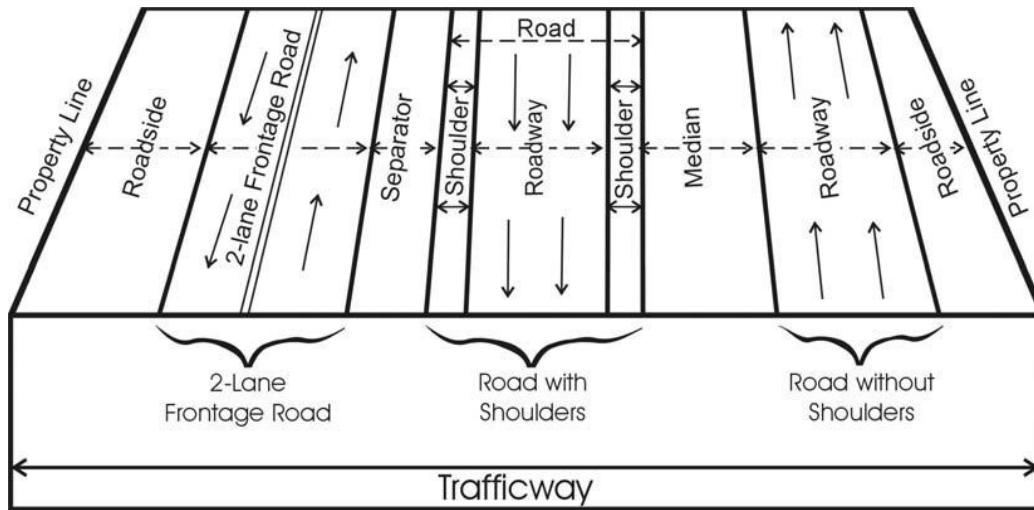

(Source: ANSI D.16 - 2017 Manual on Classification of Motor Vehicle Crashes, 8<sup>th</sup> Edition).

**TRUCK TRACTOR** – A **motor vehicle** consisting of a single motorized transport device primarily designed for pulling semi-trailers.

**UNSTABILIZED EVENT** – An event, or set of events, that originates when control is lost and terminates when control is regained; or in the absence of persons who are able to regain control, when all persons and property are at rest.

**Note:** If thorough investigation fails to establish whether a motor vehicle crash scene is the result of one or more unstabilized events, then it should be treated as a single unstabilized event. For instance, a **chain reaction crash** in which stabilization cannot be determined.

Examples:

- In a motor vehicle crash live electric wires fall on a **motor vehicle**, but there is no **injury** from the electric current while the **occupants** remain in the motor vehicle. The unstabilized event ends with the occupants in a temporary position of safety. Any subsequent injury resulting from attempts by the occupants to leave the motor vehicle or attempts by others to rescue the occupants is part of a new unstabilized event.
- In a motor vehicle crash the **occupants** of the motor vehicle are carried or thrown into water, but there is no **injury** from the submersion and the occupants reach a temporary position of safety. At this point, the unstabilized event has ended. Any subsequent injury from attempts by the occupants to reach shore, or from attempts by others to rescue the occupants is part of a new unstabilized event. An occupant of a vehicle that is a sinking vehicle, or that enters into swift moving water, is not in a 'position of safety'. In these occurrences, the unstabilized situation has not ended and any damage or injury is still part of the same unstabilized situation.
- In a motor vehicle crash the **motor vehicle** catches on fire and is burning, but all occupants have been rescued and the fire is under control. No additional **property damage** is expected. This is the end of the unstabilized event. If the heat of the fire ignites nearby combustible materials, any subsequent **injury** or **damage** from the induced ignition is not part of the original unstabilized event.
- A **pedestrian** is struck by a **motor vehicle in transport**. The pedestrian comes to rest in the **roadway**. Any subsequent **injury** resulting from contact with another motor vehicle in transport is part of a new unstabilized event.
- A **pedestrian** is struck by a **motor vehicle** and thrown into the path of another motor vehicle and the pedestrian is struck a second time before coming to rest. There is only one unstabilized event.
- A motor vehicle in transport brakes in an attempt to avoid a **pedestrian** crossing the **roadway**; however, the motor vehicle strikes the pedestrian. At the same time (i.e., when the first motor vehicle started to brake and before it came to rest), a second motor vehicle in transport swerves to avoid a collision with the

braking vehicle and strikes a utility pole. The two motor vehicles in transport did not strike each other, but these events are all within one unstabilized event.

**VEHICLE** – Any [motor vehicle](#) or [railway vehicle](#).

**WORK ZONE** – A work zone is an area of a [trafficway](#) where construction, maintenance, or utility work activities are identified by warning signs / signals / indicators, including those on transport devices (e.g., signs, flashing lights, channelizing devices, barriers, pavement markings, flagmen, warning signs and arrow boards mounted on the vehicles in a mobile maintenance activity) that mark the beginning and end of a construction, maintenance, or utility work activity.

A work zone extends from the first warning sign, signal, or flashing lights to the "End Road Work" sign or the last traffic control device pertinent for that work activity.

Work zones also include [roadway](#) sections where there is ongoing, moving (mobile) work activity such as lane line painting / marking or roadside mowing only if the beginning of the ongoing, moving (mobile) work activity is designated by warning signs or signals.

**WORK ZONE-RELATED** – A crash that occurs in or related to a construction, maintenance, or utility work zone, whether or not workers were actually present at the time of the crash. "Work zone-related" crashes may also include those involving motor vehicles slowed or stopped because of the work zone, even if the first harmful event occurred before the first warning sign. See [diagram](#) of work zone area on *page 91*.

**WORKING MOTOR VEHICLE** – A [motor vehicle](#) in the act of performing construction, maintenance, or utility work related to the [trafficway](#). This "work" may be located within open or closed portions of the trafficway and motor vehicles performing these activities can be within or outside of the trafficway boundaries. For instance, a utility truck parked off the trafficway in a field placing a concrete culvert on the trafficway. See *page 34*, [Working MV](#), for inclusions and exclusions.

# SPECIFIC RULES FOR COMPLETING THE MISSOURI UNIFORM CRASH REPORT

## I. SECTION 1 – GENERAL CRASH INFORMATION

This section is used to record general information about the crash.

### MISSOURI UNIFORM CRASH REPORT

PAGE \_\_\_\_\_ OF \_\_\_\_\_

1 — GENERAL CRASH INFORMATION					AGENCY NAME AND ORI							
SPACE USED FOR BARCODE												
LEFT THE SCENE		DRIVER NO.		CLEARED		CRASH CLASSIFICATION	PROPERTY DAMAGE ONLY	NO. INJURED	NO. KILLED	REPORT / CASE / INCIDENT NUMBER		NO. VEH. INV.
<input type="checkbox"/> Yes <input type="checkbox"/> No				<input type="checkbox"/> Yes <input type="checkbox"/> No			<input type="checkbox"/>					
CRASH DATE: MM/DD/YYYY		CRASH TIME (MIL.)		NOTIFIED DATE		TIME NOTIFIED (MIL.)		INVEST. DATE		DATE OF RDWY. CLEAR		TIME OF RDWY. CLEAR
										<input type="checkbox"/> NA		<input type="checkbox"/> NA
CRASH TYPE	ROADWAY	NON-COLLISION			COLLISION INVOLVING				DIRECTIONAL ANALYSIS FOR IMPACT WITH MOTOR VEHICLE			
	<input type="checkbox"/> On Roadway <input type="checkbox"/> Off Roadway	<input type="checkbox"/> Overturning <input type="checkbox"/> Fire/Explosion <input type="checkbox"/> Immersion <input type="checkbox"/> Jackknife <input type="checkbox"/> Fell / Jumped From MV	<input type="checkbox"/> Cargo / Equip Loss / Shift <input type="checkbox"/> Other Non-Collision <input type="checkbox"/> Thrown or Falling Object	<input type="checkbox"/> Animal <input type="checkbox"/> Pedalcycle <input type="checkbox"/> Fixed Object <input type="checkbox"/> Other Object	<input type="checkbox"/> Pedestrian <input type="checkbox"/> Struck by Falling, Shifting Cargo or Anything Set in Motion by Motor Vehicle <input type="checkbox"/> Railway Vehicle <input type="checkbox"/> Motor Vehicle in Transport <input type="checkbox"/> Parked Motor Vehicle <input type="checkbox"/> Working Motor Vehicle <input type="checkbox"/> Other Non-Motorist	<input type="checkbox"/> Front to Front <input type="checkbox"/> Front to Rear <input type="checkbox"/> Rear to Rear <input type="checkbox"/> Rear to Side <input type="checkbox"/> Angle (Front to Side)	<input type="checkbox"/> Sideswipe (Same Dir.) <input type="checkbox"/> Sideswipe (Opp. Dir.) <input type="checkbox"/> Other (Explain) <input type="checkbox"/> Unknown (Explain)					
<b>COMMERCIAL MOTOR VEHICLE INVOLVEMENT CRITERIA</b> — Answer the following to determine if the "Commercial Vehicle" fields in Section 7H must be completed.												
1. Does this crash involve any of the following? 1a. A person fatally injured; OR 1b. A person transported for medical attention; OR 1c. A vehicle towed due to disabling damage.												
<input type="checkbox"/> No — No commercial vehicle fields need completion. <input type="checkbox"/> Yes — Go to number 2.												
2. Examine each vehicle to determine if it is a commercial vehicle based upon the following: 2a. A truck / cargo van with GVWR / GCWVR of more than 10,000 lbs; OR 2b. A motor vehicle with seating for 9 or more including driver; OR 2c. A vehicle with a hazardous materials placard.												
<input type="checkbox"/> No — No commercial vehicle fields need completion. <input type="checkbox"/> Yes — Complete Section 7H for appropriate vehicle.												
EVIDENTIARY PHOTOS TAKEN		BY WHOM		AVAILABLE FROM				<input type="checkbox"/> Investigating Agency				
<input type="checkbox"/> Yes <input type="checkbox"/> No												
EVIDENTIARY VIDEO TAKEN		BY WHOM		AVAILABLE FROM				<input type="checkbox"/> Investigating Agency				
<input type="checkbox"/> Yes <input type="checkbox"/> No												
RECONSTRUCTION		BY WHOM		AVAILABLE FROM				<input type="checkbox"/> Investigating Agency				
<input type="checkbox"/> Yes <input type="checkbox"/> No												

- a. **PAGE \_\_\_ OF \_\_\_** – The first blank is the page number and the second is the total number of pages. Number additional pages using the same format.
- b. **AGENCY NAME AND ORI** – Enter agency name and Originating Agency Identifier (ORI) number. Other information pertinent to the department may be shown here.
- c. **LEFT THE SCENE** – Mark "Yes" if one or more of the [drivers](#) involved left the crash scene as defined in the glossary, page 1.
- d. **DRIVER NO.** – Enter the assigned number of the [driver\(s\)](#) who left the scene. Up to four can be shown. If more than four drivers left the scene, list additional vehicle / driver number(s) in the narrative.
- e. **CLEARED** – Complete this section if "Left the Scene" is marked "Yes." Each agency will use its own criteria to determine cleared status.  
  
**Yes** – Mark "Yes" if the status of the "Left the Scene" crash is cleared according to agency criteria.  
  
**No** – Mark "No" if the status of the "Left the Scene" crash is not cleared.
- f. **CRASH CLASSIFICATION**

**Note:** When there are no deaths, injuries, or property [damage](#), there is no crash.

[Property Damage Only](#) – Mark when no person is injured or killed.

**No. Injured** – Show the number of persons injured (Person Injury Code 2 to 4) in the crash. See [page 106](#) for a description of the [injury codes](#). Do not include fatalities.

**No. Killed** – Show the number of persons killed (Person Injury Code 1) in the crash. See *page 106* for a description of the [injury codes](#). A number higher than zero in this space indicates a fatal crash.

- g. **REPORT / CASE / INCIDENT NUMBER** – Enter report, case, or incident number assigned by the submitting agency, if applicable.
- h. **NO. VEH. INV.** – (Number of Vehicles Involved) The number of motor vehicles as well as railway vehicles directly involved in a motor vehicle crash before the situation stabilizes. **Working motor vehicles are included when engaged in a harmful event with a separate motor vehicle “in transport.”** Any subsequent contact after the situation [stabilizes](#) constitutes a separate crash.
- i. **CRASH DATE** – Enter date the crash occurred. (Use MM-DD-YYYY format).
- j. **CRASH TIME** – Using military time, enter time the crash occurred (see [General Rules](#) on *page 8* for proper format). Valid times are 0000 through 2359; 2400 is NOT a valid time.

### TIME CHART

ORDINARY TIME	MILITARY TIME	ORDINARY TIME	MILITARY TIME
1 a.m.-----	0100	1 p.m.-----	1300
2 a.m.-----	0200	2 p.m.-----	1400
3 a.m.-----	0300	3 p.m.-----	1500
4 a.m.-----	0400	4 p.m.-----	1600
5 a.m.-----	0500	5 p.m.-----	1700
6 a.m.-----	0600	6 p.m.-----	1800
7 a.m.-----	0700	7 p.m.-----	1900
8 a.m.-----	0800	8 p.m.-----	2000
9 a.m.-----	0900	9 p.m.-----	2100
10 a.m.-----	1000	10 p.m.-----	2200
11 a.m.-----	1100	11 p.m.-----	2300
Noon-----	1200	Midnight-----	0000

**Note:** For 12:00 a.m. to 12:59 a.m., the hour is "00." For example, for 12:33 a.m., the time is shown as "0033" hours. Do not use colons with military time.

- k. **NOTIFIED DATE** – Enter date the officer was notified of the crash. (Use MM-DD-YYYY format).
  - l. **TIME NOTIFIED** – Using military time, enter time the officer was notified, witnessed, or discovered the crash.
- Note:** Date and time notified cannot be before date and time of the crash.
- m. **INVESTIGATION DATE** – Enter date the officer initiated the investigation of the crash. (Use MM-DD-YYYY format).
  - n. **TIME ARRIVED** – Using military time, enter time the officer arrived at the scene of the crash.

**Note:**

- Enter the same time in "Crash Time," "Time Notified," and "Time Arrived" fields when the officer witnesses the crash.
  - Enter the same time in "Time Notified" and "Time Arrived" fields when the officer discovers the crash scene before being notified.
  - Enter "NA" if the officer does not go to the crash scene.
  - "Investigation Date" and "Time Arrived" cannot be before date and time notified.
- o. **DATE OF RDWY. CLEARANCE** – Enter the date that all [roadway](#) lanes are available for traffic flow after the crash. Mark "NA" if traffic flow is not impeded as a result of the crash.

- p. **TIME OF RDWY. CLEARANCE** – Enter the time that all **roadway** lanes are available for traffic flow after the crash. Mark “NA” if traffic flow is not impeded as a result of the crash.
- q. **INVEST. AT SCENE** – Mark "Yes" if **any** on-scene investigation was made (even if the investigation at the scene was conducted after all vehicles, etc. are removed).
- r. **CRASH TYPE** – Classifies motor vehicle crashes by type of occurrence associated with the **first harmful event**.
  - i. **ROADWAY** – Crashes are categorized in relation to **roadway** at the time of the first harmful event.
    - 1. **On Roadway** – Mark if the **first harmful event** occurred on the roadway.
 

**Note:** If the first harmful event involves a "**Parked Motor Vehicle**," then "Off-Roadway" must be marked.
    - 2. **Off Roadway** – Mark if the first harmful event occurred off the roadway.
  - ii. **NON-COLLISION** – A crash involving a **motor vehicle in transport** in which the **first harmful event** occurs in a manner other than collision.
    - 1. **Overturning** – A **motor vehicle** that has overturned at least 90 degrees to its side. This includes **motorcycles** overturning on their side.
    - 2. **Fire / Explosion** – A fire / explosion that was the first harmful event. (Make certain the fire / explosion occurred while the motor vehicle was **in transport**.)
    - 3. **Immersion** – A **motor vehicle** encounters the first harmful event by immersion into a liquid, not as a result of a **cataclysm**. Partial degree of immersion is included as long as the immersion results in a ‘harmful’ event.
    - 4. **Jackknife** – An uncontrolled articulation between a **motor vehicle** and its trailing unit(s) causing contact and damage to the vehicle and/or trailing unit(s).
    - 5. **Fell / Jumped From MV** – Motor vehicle **occupant** either involuntarily fell or intentionally leapt (not with suicidal or self-harming intentions) from the vehicle causing injury. Mark if the occupant falls or jumps from the vehicle and is struck by the vehicle.
    - 6. **Cargo / Equipment Loss / Shift** – Refers to the loss or shift of items carried on or in a **motor vehicle** or its trailing unit. **Occupants** are not considered **cargo**. The loss or shift would have to cause **damage** to the motor vehicle or occupants that is transporting the cargo / equipment or the cargo or equipment itself. If cargo / equipment is lost and strikes another vehicle that is a collision event. In regard to *Sequence of Events under Section 7*, as a non-collision event, a cargo / equipment loss or shift is not necessarily harmful. For example, the loss or release of the goods being transported from the cargo compartment of the truck, or the shifting of position of the load affecting its balance.
    - 7. **Other Non-Collision** – A crash involving a **motor vehicle in transport**, other than a collision or those circumstances listed above.

Includes, but is not limited to:

- a. When the damaging event is the undercarriage of the **motor vehicle** striking the **roadway** over which the vehicle is traveling. This includes a motor vehicle striking a pavement blow-up.
- b. Driving off a cliff where **damage** is not the result of an overturn or a collision with a **fixed object**.

- c. An unbelted **occupant** hits his or her head on the roof of a motor vehicle and is injured when the vehicle travels over a sharp dip in the road.
- d. Situations where an occupant is sickened or dies due to carbon monoxide fumes leaking from a **motor vehicle in transport**.
- e. Breakage of any part of motor vehicle, resulting in **injury** or in further property **damage** to the same vehicle or **occupants**.
- f. Toxic or corrosive chemicals leaking out of motor vehicle.
- g. **Injury** or **damage** involving only **motor vehicle** of non-collision nature, such as an overpass bridge giving way under the weight of a motor vehicle, without overturning or collision.
- h. Other **injury** or **damage** originating on or in motor vehicle.
- i. A towed unit becomes disengaged from the power unit and strikes or does damage to the power unit.

Excludes:

- a. Events not associated with transport, such as a fight between **occupants**, occupant injured by a burning cigarette, firearm discharging in a motor vehicle, or similar events.
  - b. Carbon monoxide poisoning in a **motor vehicle not in transport**.
  - c. Breakage of any **motor vehicle** part, such as a fan belt or axle, with no additional **damage** or **injury**.
  - d. **Injury** or **damage** resulting from working on a motor vehicle not in transport.
8. **Thrown / Falling Object** – The **motor vehicle** is struck by a thrown or falling object. This excludes contacts with loads/**cargo** or objects set in-motion from/by another **motor vehicle in transport**. It also excludes thrown or fallen objects that have come to rest as these would be considered “**other objects**.”

Examples:

- A tree limb falls from a tree onto a motor vehicle in-transport that is not a direct result of a cataclysm.
- A person unintentionally throws a baseball into the windshield of a motor vehicle in-transport.
- A riding mower engaged in a mowing operation (not a working motor vehicle) projects a rock onto a motor vehicle in-transport causing damage.
- And others.

- iii. **COLLISION INVOLVING** – A crash involving a **motor vehicle in transport** in which the **first harmful event** occurs during a collision with one of the following:

- 1. **Animal** – This includes only live animals. Dead animals are considered “other objects.” An animal being ridden or an animal drawn conveyance with a person(s) is considered an “**other non-motorist**.” An animal drawn conveyance not occupied by a person(s) is considered an “**other object**.”

Indicate the type of animal under *Animal Codes* in [Section 8 - Codes](#) and its disposition in [Section 9 - Narrative / Statements](#).

A collision involving a wild animal, i.e., having no monetary value, where no other **damage** is sustained is not a motor vehicle crash. Conversely, a collision involving a domestic animal with monetary value would be a motor vehicle crash regardless of any other **damage** sustained.

- 2. **Pedalcycle** – A device operated by pedals, which can be propelled by human power and/or a motor.

Includes (but is not limited to): Bicycle, tricycle, unicycle, or pedal car, etc. Also includes a sidecar or trailer attached to any of these devices.



Excludes: [Motorized bicycles/mopeds](#). Also, these devices when towed by a motor vehicle including "hitching" (clinging to or being pulled by a motor vehicle).

Mark when the cyclist was in transport at the time of the crash. A stopped pedalcycle is in transport if it is attended and in readiness for motion, such as stopped at a stop sign, traffic light, or waiting in traffic. The cyclist need not be occupying the riding saddle/seat, but cannot be pushing the pedalcycle. A person pushing a pedalcycle is a [pedestrian](#). A coasting pedalcycle with a rider is in transport.

3. **Fixed Object** – A fixed object is any object not in motion and attached to, or part of the terrain. Indicate the fixed object(s) struck under *Fixed Object Code(s) in Section 8 - Codes*. Describe [damaged](#) property, other than vehicles, in *Section 3 - Damage to Property Other Than Vehicles*.

Includes (but is not limited to):

- a. Any object attached to or a part of the terrain.
- b. Tree / stump (standing), embankment / [driveway](#) / ground / rock bluff, guardrail face, utility pole / guy wire, fence, street light support, culvert, highway traffic sign post / support, bridge pier / abutment / support, curb, mailbox, concrete traffic barrier, building, traffic signal support, [impact attenuator / crash cushion](#), fire hydrant, [bridge parapet](#) end, bridge rail, guardrail end, [median](#) / other traffic barrier, overhead sign support, ditch, other posts / poles / supports, wall, cable barrier, bridge overhead structure, overhead line / cable, or crops. (Refer to [Section 8 - Codes](#) on page 123 for a description of each of these objects).
- c. When the first damaging event is the undercarriage striking something OFF the [roadway](#) over which the vehicle was traveling.

**Note:** Crashes in which the first damaging event occurs when the vehicle overturns should be marked "Overturning" (above under "Non-collision") rather than "Fixed Object."

4. **Other Object** – An object which is moveable or moving and not fixed. Describe other objects struck in *Section 9 - Narrative / Statements* and list [damaged](#) property in *Section 3 - Damage to Property Other Than Vehicles*.

Includes (but is not limited to):

- a. Deceased person
- b. Objects dropped from [motor vehicle](#), but not in motion
- c. Special devices not considered [in transport](#) or fixed objects
- d. Fallen tree or stone
- e. Landslide or avalanche materials not in motion
- f. Collision with a snowbank
- g. [Pedalcycle](#) not [in transport](#)
- h. Railway devices moved by human power
- i. Non-motorized devices not set in motion by [railway vehicle](#) such as a railway boxcar not set in motion by a railway vehicle
- j. Unattached trailer not set in motion by a [motor vehicle](#)
- k. All other objects excluding those listed below
- l. [Work zone](#) / maintenance equipment - Any object intentionally placed **for an official purpose** such as traffic barricades, road or construction machinery (not a [working motor vehicle](#) or motor vehicle [in transport](#)), construction materials, or similar objects placed on or along the [roadway](#) for the purposes of a work zone or for maintenance.

- m. **Motor vehicles** within the confines of a building
- n. Dead animal or animal carcass
- o. Animal drawn conveyance without a person(s)

Excludes:

- a. Live animal
  - b. **Pedalcycle**
  - c. **Fixed object**
  - d. **Pedestrian**
  - e. **Railway vehicle**
  - f. Animal drawn vehicle / animal ridden transportation (**other non-motorist**)
  - g. **Motor vehicle in transport**
  - h. **Parked motor vehicle**
  - i. **Working motor vehicle**
  - j. Objects set in motion by aircraft, watercraft, pedalcycle with pedalcyclist, **railway vehicle, motor vehicle in transport, working motor vehicle, or other transport device with other non-motorist.**
  - k. Objects set in motion by **cataclysm.**
5. **Pedestrian** – Any person who is not an **occupant**, in or on, a **vehicle** or **other transport device**.

**Note:** It is important to ascertain exactly where the person was located in relationship to their transition into or out of the vehicle. Once the **unstabilized situation** begins, a pedestrian remains a pedestrian until the crash stabilizes.

- If a person is on his/her feet outside the vehicle, he/she is considered a pedestrian.
- If a person is entering or exiting a vehicle, ensure he/she has successfully completed the transition from pedestrian to occupant or vice-versa.

Includes (but is not limited to):

- a. Person on foot
- b. Person walking, running, jogging, hiking, sitting, or lying within the **trafficway** or on private property, etc.
- c. Persons in buildings
- d. Person on **personal conveyance**
  - i. Rideable toys
    - 1. Roller skates, in-line skates
    - 2. Skateboard
    - 3. Toy car (Not motorized)
    - 4. Baby carriage
    - 5. Scooter (Not motorized)
    - 6. Toy wagon
  - ii. Motorized rideable toys
    - 1. Motorized skateboard
    - 2. Motorized toy car
  - iii. Devices for personal mobility assistance
    - 1. Segway-style device
    - 2. Motorized and non-motorized wheelchair
    - 3. Handicapped scooter
- e. A person ejected from a transport vehicle who has come to rest during a prior unstabilized situation and is not deceased; and is struck in a second or subsequent unstabilized situation.

Excludes:

- a. A person ejected from a transport vehicle during one unstabilized situation who has not come to rest is still considered an occupant and not a pedestrian for the purposes of that unstabilized situation.
- b. A deceased person is considered an "Other Object." For example, a pedestrian is fatally struck, comes to rest on the roadway, and the crash event stabilizes. The corpse is then struck by another motor vehicle. The corpse involved in the second crash is considered an "Other Object."
- c. Pedalcyclists and other non-motorists.

6. **Struck by Falling, Shifting Cargo or Anything Set in Motion by Motor Vehicle** – A motor vehicle "in transport" is struck by load/cargo or anything that is set in motion by a separate motor vehicle resulting in a harmful event. A load/cargo that falls from a motor vehicle is considered part of the motor vehicle until the load/cargo comes to rest at which point it becomes an "other object." The motor vehicle that was struck as well as the motor vehicle losing the cargo or setting something in motion should be counted as vehicles involved in the crash.

Examples:

- A motor vehicle in transport is struck by cargo that falls from a pickup truck also in transport before the cargo comes to rest on the roadway.
  - A motor vehicle in transport is struck by an object that is in motion after being struck by another motor vehicle in transport. The first / initial impact between the object and motor vehicle did not result in a harmful event.
  - A motor vehicle in transport is struck by an animal that is in motion after being struck by another motor vehicle in transport. The first / initial impact between the animal and motor vehicle did not result in a harmful event.
7. **Railway Vehicle** – Any device, with or without coupled cars, designed for transport on a railway. Includes any device designed to operate on railway tracks under its own power, such as a motor vehicle equipped with flange wheels. A non-motorized device, unattached from the power unit, or not set in motion by a power unit, is not a railway vehicle, e.g., boxcar sitting on rails not attached to an engine is an "other object."
8. **Motor Vehicle In Transport** – A motor vehicle being used for moving persons or property from one place to another, and is either in motion, in readiness for motion, or on a roadway, but not parked in a designated parking area. Includes a motor vehicle moving, stopped, disabled, or abandoned on a roadway other than areas designated for parking. **Note:** Occupants ejected from a motor vehicle and hit (before stabilization) are still part of the vehicle.
9. **Parked Motor Vehicle** – A parked motor vehicle is a motor vehicle not in-transport, other than a working motor vehicle, that is not in motion, not located on the roadway, and is in a designated parking area.

In roadway lanes used for travel during some periods and for parking during other periods, a parked motor vehicle should be considered to be in-transport during periods when parking is forbidden.

If a vehicle is stopped and legally parked, it is considered a parked motor vehicle and the vehicle is considered "off roadway." If a vehicle is stopped on a roadway, but not in a designated parking area, it is considered a motor vehicle in transport and the vehicle is considered "on roadway." This is regardless of whether the vehicle is occupied or not.

Includes:

Any stopped motor vehicle where the entirety of the vehicle's primary outline as defined by the four sides of the vehicle (e.g., tires, bumpers, fenders) and load, if any, is not on the **roadway**.

Examples:

- i. A driver of a **motor vehicle** stopped curbside on a city street opens his door into the travel lane.
- ii. A truck stopped on the **shoulder** where only the extended side-view mirror overhangs the roadway edge line.
- iii. A motionless motor vehicle on the **shoulder, median, or roadside**.
- iv. A truck stopped at a gas station pump or stopped at the exit from a gas station and waiting to enter the roadway.
- v. A car parked in a metered parking lane, even when the meter time has expired.
- vi. A car stopped as far to the right as possible on a gravel **road** (i.e., legally parked), but with part of the car still on the traveled portion of the road.

Excludes:

- a. A **motor vehicle** in motion.
- b. A motor vehicle stopped and not in a designated parking area.
- c. A motor vehicle left unattended on a **roadway**, where parking is always prohibited.

Examples:

- i. A motor vehicle driving down the road **shoulder, median, or roadside**.
- ii. A driverless motor vehicle without engine power starts in motion from a stopped position on the **shoulder**.
- iii. A stopped motor vehicle partially on the **shoulder** of an interstate highway with two tires on the **roadway**.
- iv. A tractor-trailer with part of its load extending over the roadway edge line.
- v. A motor vehicle left unattended in a lane during rush hour when parking is prohibited because it is in an open travel lane at the time.
- vi. A delivery service driver leaves his/her truck stopped at the curb of a street marked with "no parking at any time" signs while making a delivery.

10. **Working Motor Vehicle** – A **motor vehicle** in the act of performing construction, maintenance, or utility work related to the **trafficway**. This "work" may be located within open or closed portions of the trafficway and motor vehicles performing these activities can be within or outside of the trafficway boundaries. Working motor vehicles are not considered "in-transport."

Includes (but is not limited to):

- a. A **motor vehicle** at work in a marked **work zone**.
- b. A motor vehicle at work on the **median, shoulder, or roadside**.
- c. A mobile maintenance convoy.
- d. A law enforcement **motor vehicle** participating strictly in a stationary construction or mobile maintenance activity as a traffic slowing, control, signaling, or calming influence.

Examples:

- i. Asphalt roller working in a highway **work zone**.
- ii. State highway maintenance crew mowing grass on **roadside**.
- iii. Utility truck performing maintenance on the power lines along the **roadway**.
- iv. A private excavating company contracted by the state digging the foundation for a new overpass.

Excludes:

- a. A **motor vehicle** performing a private construction / maintenance activity not in association with the **trafficway**.
- b. A law enforcement motor vehicle performing other work activities, such as traffic stops, crash investigation, patrolling and traffic control not related to construction, maintenance, or utility work on the **trafficway**.
- c. A motor vehicle performing a work activity other than highway construction, maintenance or utility work.
- d. A construction, maintenance, utility **motor vehicle** while moving from one job site to another.
- e. A utility motor vehicle parked on the **trafficway** where no component of the vehicle is engaged in the work being performed.
- f. A homeowner mowing the portion of their lawn within the trafficway boundary because they are not hired or contracted to perform the trafficway maintenance activity.

Examples:

- i. An excavation company digging a foundation for a new building.
- ii. Garbage truck, delivery truck, taxi, emergency vehicle, tow truck, etc.

11. **Other Non-Motorist** – A person who is an occupant of a mechanically or electrically powered device that is **NOT** a **motor vehicle** (in **transport** or **parked**), **working motor vehicle, railway vehicle, personal conveyance, or pedalcycle**. Other non-motorists would also include occupants of an "**other transport device**."

**Note:** The other transport device that is occupied by the "other non-motorist" is still considered "other non-motorist."

Examples:

- i. Person on a riding mower engaged in a mowing operation off the trafficway.
- ii. Person on agriculture equipment (tractor, combine, etc.) engaged in an agriculture operation in a farm field such as disking, plowing, harvesting, etc.
- iii. Person on construction equipment (stationary or moving) digging a ditch off the trafficway.
- iv. Person on a buggy or other device harnessed to a horse or other animal on or off the trafficway.
- v. Person on a horse or other animal on or off the trafficway.

#### iv. DIRECTIONAL ANALYSIS FOR IMPACT WITH MOTOR VEHICLE

Identifies the manner in which two **motor vehicles**, either **parked** or **in transport**, or a **working motor vehicle**, initially came together without regard to the direction of force. This refers only to crashes where the **first harmful event** involves a motor vehicle in transport, parked motor vehicle, or working motor vehicle.

(Source of Illustrations: MMUCC)

1. **Front to Front** – The front end of one motor vehicle collides with the front end of another vehicle.

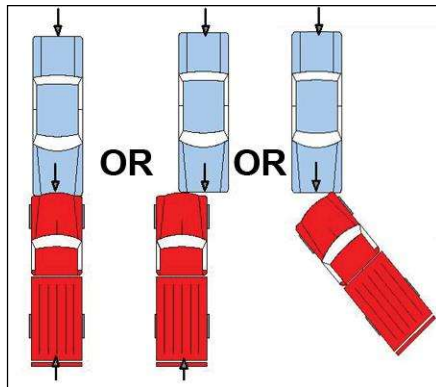

2. **Front to Rear** – The front end of one motor vehicle collides with the back of another vehicle or vice-versa (the rear of one vehicle collides with the front of another).

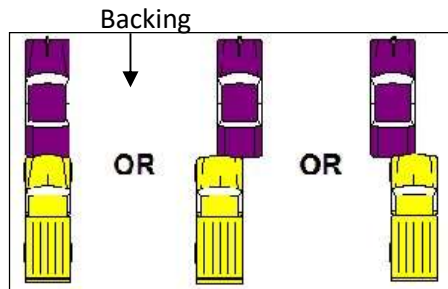

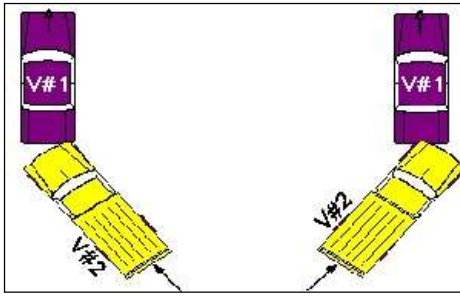

3. **Rear to Rear** – The rear of a **motor vehicle** makes contact with the rear of another. This can happen when two vehicles are backing up or when one vehicle backs into the rear of a parked vehicle.

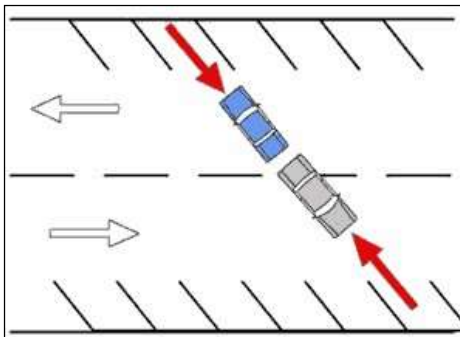
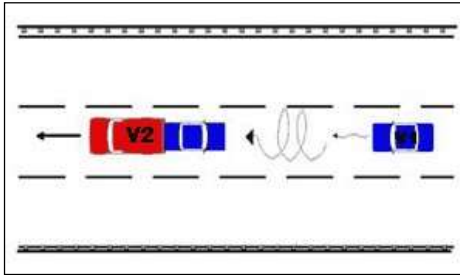

4. **Rear to Side** – The rear of a **motor vehicle**, not the front, makes contact with the side of another vehicle.

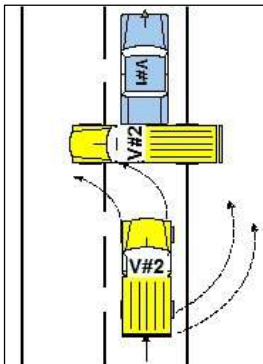

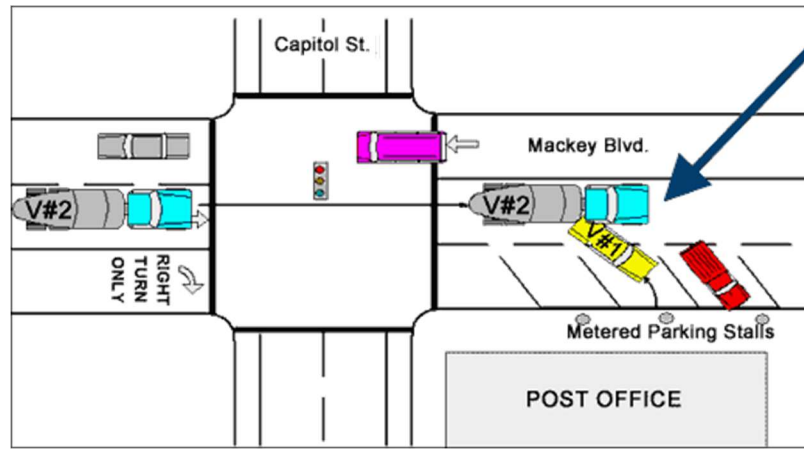

5. **Angle** – Two motor vehicles impact at an angle front to side.

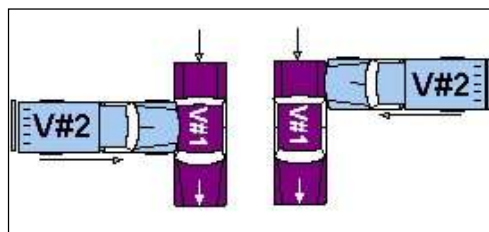
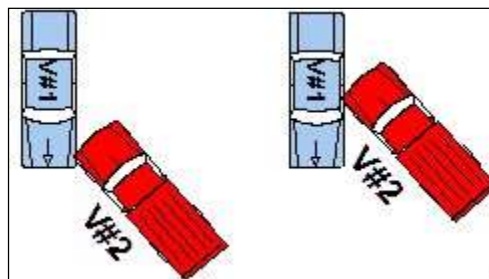
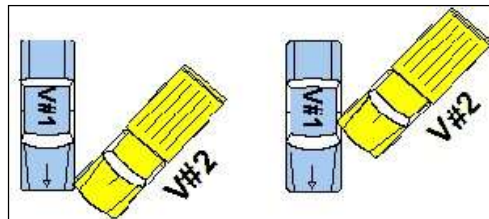

6. **Sideswipe (Same Dir.)** – Two motor vehicles traveling or facing in the same direction impact one another where the initial engagement does not overlap the corner of either vehicle so that there is not significant involvement of the front or rear surface areas. The impact then swipes along the surface of the vehicle parallel to the direction of travel.

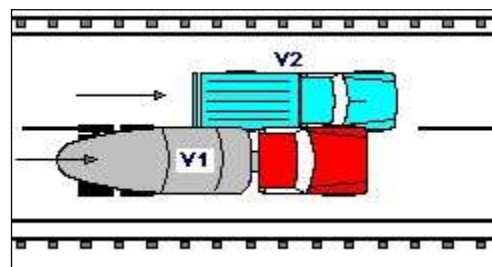



7. **Sideswipe (Opp. Dir.)** – Two **motor vehicles** traveling or facing in the opposite direction impact one another where the initial engagement does not overlap the corner of either vehicle so that there is no significant involvement of the front or rear surface areas. The impact then swipes along the surface of the vehicle parallel to the direction of travel.

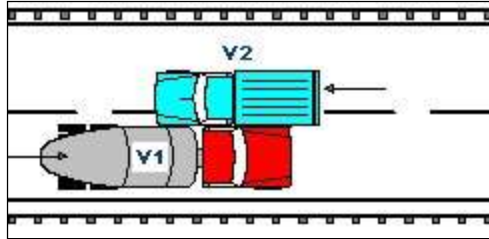

8. **Other (Explain)** – Used for any collision between two **motor vehicles** where the collision is not described by the other attributes above. Describe direction of collision in [Section 9 - Narrative / Statements](#).

Examples:

- a. When one motor vehicle is airborne and makes contact with its front to the other vehicle's hood or top.
- b. A motor vehicle **occupant** or motorcyclist falls or is thrown from a vehicle striking or is struck by another vehicle.
- c. A wheel / tire or other **motor vehicle** part comes off a motor vehicle in-transport striking another motor vehicle.
- d. A rock or other debris, not part of a motor vehicle's cargo, is put in motion by a motor vehicle in-transport striking another motor vehicle.

9. **Unknown (Explain)** – Used when direction of collision is unknown. Explain why this is unknown in [Section 9 - Narrative / Statements](#).

- s. **COMMERCIAL MOTOR VEHICLE INVOLVEMENT CRITERIA** – Complete to identify whether the *Commercial Motor Vehicle* portion of [Section 7H - Commercial Motor Vehicle](#) must be completed.

1. **Does this crash involve any of the following?**

- 1a. A person fatally injured; OR
- 1b. A person transported for medical attention; OR
- 1c. A vehicle towed due to disabling damage.

**NO** – If none of these apply, mark "No" and do not continue to number 2 of the commercial motor vehicle involvement criteria and do not complete [Section 7H - Commercial Motor Vehicle](#).

**YES** – If any of these apply, mark "Yes" and continue to number 2 of the Commercial Motor Vehicle Involvement Criteria.

2. **Examine each vehicle to determine if it is a commercial vehicle based upon the following:**

- 2a. A truck / cargo van with Gross Vehicle Weight Rating (**GVWR**) or Gross Combined Vehicle Weight Rating (**GCVWR**) of more than 10,000 pounds; OR

2b. A **motor vehicle** with seating capacity of 9 or more including the driver; OR

2c. A vehicle displaying hazardous materials placard.

**NO** – If none of these were involved, mark "No" and do not complete [Section 7H - Commercial Motor Vehicle](#).

**YES** – If any of these were involved, mark "Yes" and complete [Section 7H - Commercial Motor Vehicle](#).

- t. **EVIDENTIARY PHOTOS TAKEN** – Mark the appropriate box to indicate whether photos were taken, obtained, or collected as part of the crash investigation, either by, or at the direction of, the investigator.

**YES** – Photos were taken, obtained, or collected as part of the crash investigation.

**NO** – Photos were not taken, obtained, or collected as part of the crash investigation.

i. **By Whom** – Enter photographer's name.

ii. **Available From** – Mark the "Investigating Agency" box if the photos are available from the investigator's agency. If not, enter the department, division, or officer storing the photos.

- u. **EVIDENTIARY VIDEO TAKEN** – Mark the appropriate box to indicate whether a video(s) was recorded, obtained, or collected as part of the crash investigation, either by, or at the direction of, the investigator. This would include video from surveillance / security cameras, vehicle dash camera system, etc.

**YES** – Video(s) was recorded, obtained, or collected of the motor vehicle crash or as part of the crash investigation.

**NO** – Video(s) was not recorded, obtained, or collected of the motor vehicle crash or as part of the crash investigation.

i. **By Whom** – Enter videographer's name.

ii. **Available From** – Mark the "Investigating Agency" box if the video(s) is available from the investigator's agency. If not, enter the department, division, or officer storing the video(s).

- v. **RECONSTRUCTION** – Mark the appropriate box to indicate whether the crash was reconstructed.

**YES** – A reconstruction was completed of the motor vehicle crash.

**NO** – A reconstruction was not completed of the motor vehicle crash.

i. **By Whom** - Enter the reconstructionist's name.

ii. **Available From** - Mark the "Investigating Agency" box if the reconstruction report is available from the investigator's agency. If not, enter the department, division, or officer from whom the report is available.

## II. SECTION 2 – LOCATION

This section describes the location of the crash. Crashes should be located based on the following: If the **first harmful** (**injury** or **damage** producing) event occurred on the **roadway**, locate the crash to the roadway where the event occurred. If the vehicle left the roadway unintentionally before the **first harmful event**, locate the crash to where the vehicle initially left the roadway (even if the vehicle returns to and the first harmful event occurs on the roadway). See examples in [Appendix E, page 158](#).

2—LOCATION										
COUNTY		MUNICIPALITY		BEAT / ZONE	TRP/DIST/PCT	GPS COORDINATES (DD MM SS.S FORMAT)				
						LAT: N		LONG: W		
ON			RDWY. DIR.	DISTANCE FROM	LOCATION		INTERSECTING			
				<input type="checkbox"/> NA	<input type="checkbox"/> After <input type="checkbox"/> NA					
				Feet	<input type="checkbox"/> Before					
				Miles	<input type="checkbox"/> At					
SPEED LIMIT	ROADWAY MAINTAINED BY <input type="checkbox"/> Unknown					SPEED LIMIT		INT. DIR.	GEO—CODE	
	<input type="checkbox"/> State <input type="checkbox"/> County <input type="checkbox"/> Municipal <input type="checkbox"/> Private Property <input type="checkbox"/> Other									
TRAFFICWAY				ROADWAY ALIGNMENT			ROADWAY PROFILE			
<input type="checkbox"/> One-Way <input type="checkbox"/> Two-Way; Not Divided <input type="checkbox"/> Two-Way; Divided; Unprotected Median <input type="checkbox"/> Other				<input type="checkbox"/> Straight <input type="checkbox"/> Curve			<input type="checkbox"/> Level <input type="checkbox"/> Downhill <input type="checkbox"/> Dip			
<input type="checkbox"/> Two-Way; Not Divided; Continuous Center Turn Lane <input type="checkbox"/> Two-Way; Divided; Positive Median Barrier <input type="checkbox"/> Unknown				<input type="checkbox"/> Unknown (Explain)			<input type="checkbox"/> Uphill <input type="checkbox"/> Hillcrest <input type="checkbox"/> Unknown (Explain)			
INTERSECTION TYPE				ROUNDABOUT / TRAFFIC CIRCLE			ROADWAY CONDITION		ROADWAY SURFACE	
<input type="checkbox"/> NA				<input type="checkbox"/> Roundabout <input type="checkbox"/> Other (Explain)			LIGHT CONDITION		WEATHER / ENVIRON CONDITION	
<input type="checkbox"/> PERPENDICULAR				<input type="checkbox"/> Other Circular Intersection <input type="checkbox"/> Unknown (Explain)						
<input type="checkbox"/> Cross Intersection (4-Way)										
<input type="checkbox"/> T-Intersection										
<input type="checkbox"/> ANGLED/SKEWED										
<input type="checkbox"/> Y-Intersection										
<input type="checkbox"/> Five or More Legs and Not Circular										

- COUNTY** – Enter the name of the county in which the crash occurred. Exception: Crashes occurring in the City of St. Louis enter "St. Louis City."
- MUNICIPALITY** – Enter name of the incorporated city, town, or village in which the crash occurred. If the area is unincorporated, enter "NA."
- BEAT / ZONE** – Enter the appropriate number(s) or letter(s) to indicate the beat or zone in which the crash occurred. Enter "NA" if this field is not applicable.
- TRP / DIST / PCT** – Enter the appropriate number(s) or letter(s) to indicate the troop, district, or precinct in which the crash occurred. Enter "NA" if this field is not applicable.
- GPS COORDINATES** – Enter the appropriate location latitude and longitude coordinates using the DD MM SS.S (decimal seconds) format and WGS84 datum setting. The maximum latitude can be 40 degrees with the minimum being 35. The maximum longitude can be 95 degrees with the minimum being 89.
- ON** – Street, highway, or privately owned or public **trafficway** or property on which the crash occurred.

Crashes should be located based on the following: If the **first harmful event** occurred on the **roadway**, locate the crash to the roadway where the event occurred. If the vehicle left the roadway unintentionally before the first harmful event, locate the crash to where the vehicle initially left the roadway. If a crash does not involve a roadway, locate the crash at the first harmful event. See examples in [Appendix E, page 158](#).

Enter **route designation** (IS, US, MO, RT, CST, RP, etc.), then the number, letter, or full street name (70, 63, 13, A, Broadway AVE, etc.) of the road, street, or highway on which the crash occurred as listed in the, [MoDOT Location Book](#) or [MoDOT HPMAPS](#). Example: IS 70, US 63, MO 13, RT A, CST Broadway AVE, RP 104221, etc. Bridge names / numbers, Emergency Reference Markers (ERM), and junction values cannot be shown in this field.

See examples for crashes occurring at weigh station (WS) or rest areas (RA) in [Appendix E, page 196](#). See an example for a crash occurring on a **reversible** (RV) roadway in [Appendix E, page 198](#).

**Note:** Crashes within interchanges are located to the roadway on which they occur, i.e., **ramps**, overpasses, primary roadway, etc. Ramp numbers must be used when a crash occurs on a ramp. The numbers can be found on the MoDOT Location Book or the MoDOT Interactive Mapping Tool. For example, a crash occurring on ramp number 6998, located on IS 70

eastbound at US 54, will be shown in this field as "RP 6998." See example in [Appendix E, page 178](#). Ramps can overlap other ramps. The method for locating crashes on overlapping ramps is explained in [Appendix E, Example #7 \(Diverging Diamond Interchanges\), page 187](#), and [Example #8 \(Directional Interchanges\), page 190](#).

When route names are not appropriate or there is no name, it is permissible to use "private lane," "private road," "alley," "city street (unnamed)," etc. However, there must be a route designation (PP, PVT, ALY, etc.) shown preceding the name. Roadways that are maintained by government agencies, but are not state, city, or county routes (i.e., roads on state university campuses, park roads, airport roads, etc.) should be assigned the PVT route designator.

See [page 46](#) for [examples](#) of locating private property crashes.

The following standard abbreviations must be used in street names (rather than spelling out the entire word). **DO NOT use periods at the end of these abbreviations:**

Avenue	AVE
Boulevard	BLVD
Circle	CIR
Court	CT
Cutoff	CUTOFF (Not abbreviated)
Drive	DR
Expressway	EXPY
Highway	HWY
Lane	LN
Parkway	PKWY
Park Road	PK
Place	PL
Road	RD
Street	ST
Terrace	TER
Trafficway	TRFY

The exact address or block number (with the street name) of the crash may be indicated in this field; however, the route designation, along with the "Roadway Direction," "Distance From," "Location," and "Intersecting Street or Roadway" fields must be completed.

Example:

ON CST 4325 West 25th AVE		RDWY. DIR. S	DISTANCE FROM 150 <input type="checkbox"/> NA Foot	LOCATION <input checked="" type="checkbox"/> After <input type="checkbox"/> NA <input type="checkbox"/> Before <input type="checkbox"/> At	INTERSECTING CST College CIR
SPEED LIMIT 25	ROAD MAINTAINED BY <input type="checkbox"/> Unknown <input type="checkbox"/> State <input type="checkbox"/> County <input checked="" type="checkbox"/> Municipal <input type="checkbox"/> Private Property <input type="checkbox"/> Other		Miles		SPEED LIMIT NA
					INT. DIR. E
					GEO - CODE NA

When entering roadway information, the following route designations must be used:

IS	Interstate	CO	Connector for Wye Leg
US	U.S. Highway	EOR	East Outer Road
MO	State Numbered	NOR	North Outer Road
RT	State Lettered	SOR	South Outer Road
AL	Alternate Route	WOR	West Outer Road
LP	Loop (Interstates Only)	PVT	Private Road
BU	Business Route (US or MO only)	RV	Reversible
SP	Spur	RA	Rest Area
CST	City Street	WS	Weigh Station
RP	Ramp	ALY	Alley
CRD	County Road	BRIDGE	Bridge
PP	Private Property	ERM	Emergency Reference Marker
DOD	Department of Defense	COE	Corp of Engineers
FWS	Fish and Wildlife	NFS	National Forest Service
NPS	National Park Service	PK	Park Road

**Note:** "PP" (Private property) includes unnamed private roads, private property other than marked (or named) private roads and [parking lots](#). "PVT" (Private Road) is used for named private roads.

- g. **RDWY. DIR.** - (Roadway Direction) Enter the route direction (N, S, E, or W) in this field. Only "N", "S", "E", or "W" can be used. For instance, "NE" or "SW" cannot be used. If the [first harmful event](#) occurred off the [roadway](#), use the roadway direction of the lane where the vehicle initially left the roadway. If the first harmful event is on the roadway, use the roadway direction of the lane where the first harmful event occurred. For one lane bridges used by vehicles traveling in opposite directions as well as continuous left turn lanes, either roadway direction can be used.

Enter "NA" for crashes occurring on private property (PP). (See [examples](#) on [page 46](#)).

The route direction is listed on the [MoDOT Location Book](#) or the [MoDOT Interactive Mapping Tool](#) along with associated intersecting routes. All even numbered routes are east / west, and all odd numbered routes are north / south; this includes circumferential routes such as IS 435, IS 270, etc. The lettered route direction, i.e., RT A, is determined by the overall direction of the route from beginning to end. The direction of travel can be determined by comparing intersections on the [MoDOT Location Book](#) or the [MoDOT Interactive Mapping Tool](#) with intersections on the route where the crash occurred.

**Note:** This is the overall [roadway](#) direction and not necessarily the compass direction the motor vehicles were traveling. If the compass direction of the vehicle differs from the overall direction of the roadway (for instance a vehicle proceeding northbound on an east / west roadway), note this information in the narrative.

- h. **DISTANCE FROM** – Enter the distance to the crash scene from the nearest intersecting street, [roadway](#), [ramp](#), or beginning of a bridge structure as listed on the [MoDOT Location Book](#) or the [MoDOT Interactive Mapping Tool](#). The distance from the crash scene to an Emergency Reference Marker ([ERM](#)) may also be used. Enter distances in feet or miles. If entered in miles, distances must be reported in no less than hundredths, i.e., 3.13. The distance must be measured to the nearest edge of the roadway, beginning of a bridge structure, or from an [ERM](#). When locating a crash on a ramp, measure to or from the painted gore (where the ramp leaves or joins a roadway) or to the nearest [roadway](#) when a gore is not present. If the distance cannot be determined, enter "Unk" in either the "Feet" or "Miles" fields. "Unk" cannot be entered if the crash was investigated at the scene.

**NA** – Mark if the crash is at the intersecting street, [roadway](#), [ERM](#), or beginning of a bridge structure. If "NA" is selected, then "At" must be selected in the "Location" field (below). "NA" cannot be selected for private property (PP) crashes (i.e., parking lots, fields, yards, unmarked / unnamed private roads, etc.), but can be used for crashes occurring on a marked / named private road (PVT).

See [page 46](#) for examples of locating [private property crashes](#).

See definition of "[intersection](#)" in glossary ([page 15](#)) and examples of measurements to intersections in [Appendix E, page 158](#).

- i. **LOCATION** – Indicate crash location from intersecting street, [roadway](#), [ramp](#), or BEGINNING of a bridge structure as listed on the [MoDOT Location Book](#) or the [MoDOT Interactive Mapping Tool](#), or Emergency Reference Marker ([ERM](#)), by marking "After" or "Before" the referenced [intersection](#), ramp, ERM, or bridge structure in the same county as the 'On' street or highway. Always use the roadway direction relating to the "On" field to determine "After" or "Before." See examples in [Appendix E, page 158](#).

**After** – Mark if the crash occurred after an intersection, [ERM](#), or beginning of bridge structure (entered in the "Intersecting" field). "After" is based on the roadway direction (entered in the "Rdwy. Dir." field) of the lane in which the [first harmful event](#) occurred or the lane where the [motor vehicle](#) initially left the [roadway](#).

**Before** – Mark if the crash occurred before an [intersection](#), [ERM](#), or beginning of bridge structure (entered in the "Intersecting" field). "Before" is based on the roadway direction (entered in the "Rdwy. Dir." field) of the lane in which the [first harmful event](#) occurred or the lane where the [motor vehicle](#) initially left the [roadway](#).

**At** – Mark if the crash occurred within the confines of the [intersection](#), or at an [ERM](#) or beginning of a bridge structure. If marked, then "NA" must be selected in the "Distance From" field (above).

**NA** – Mark if this information is unknown or the crash occurs on private property (PP), (i.e., [parking lots](#), fields, yards, unmarked / unnamed private roads, etc.) If selected for a crash on private property (PP), a valid number (feet or miles) must be entered in the "Distance From" field (above). See [page 46](#) for examples of locating [private property crashes](#).

j. **INTERSECTING**

- i. Intersecting street, [roadway](#), [ramp](#), bridge structure, or emergency reference marker ([ERM](#)) in the same county as the 'On' street or highway.

The intersecting street name, roadway name, ramp number, or bridge structure number MUST match the name or number listed on the [MoDOT Location Book](#) or the [MoDOT Interactive Mapping Tool](#).

- **Intersecting roadways** – Enter route designation (IS, US, MO, RT, CST, RP, etc.), then the number, letter, or full street name (70, 63, 13, A, Broadway AVE, etc.) of the nearest intersecting road, street, highway, or ramp listed on the [MoDOT Location Book](#) or the [MoDOT Interactive Mapping Tool](#). Example: IS 70, US 63, MO 13, RT A, CST Broadway AVE, RP 104221, etc. Location of crashes to or from unnamed roadways, such as unnamed private roads, should be avoided.

Intersecting [roadways](#) listed on the [MoDOT Location Book](#) or the [MoDOT Interactive Mapping Tool](#) will be used except when a crash occurs within an [intersection](#) where the intersecting roadway is not listed. In these cases, the crash must be shown as occurring at the unlisted roadway. The crash location to the nearest street, roadway, ramp, or bridge structure listed on the [MoDOT Location Book](#) or the [MoDOT Interactive Mapping Tool](#) must then be identified in [Section 9 - Narrative / Statements](#). The "Distance From" and "Location" fields must be shown along with the route designator (US, MO, RT, RP, BRIDGE, etc.) and name of the street, roadway, bridge structure number, or ramp number. (See examples in [Appendix E, page 158](#)).

Crashes that occur on ramps listed on the [MoDOT Location Book](#) or the [MoDOT Interactive Mapping Tool](#) are referenced to the entrance or exit gore (where the ramp leaves or joins a roadway), or to the roadway intersecting with the ramp. (See example in [Appendix E, page 178](#)).

When two [roadways](#) with the same name intersect more than once within a county, the following must be entered in parenthesis after the roadway name:

- If two or three [intersections](#), use the appropriate letters from the [MoDOT Location Book](#) or the [MoDOT Interactive Mapping Tool](#): (NJ) - North Junction; (SJ) - South Junction; (EJ) - East Junction; (WJ) - West Junction; (MJ) - Middle Junction to indicate the junction being referenced. See diagram in [Appendix E, page 193](#).
- If four or more intersections, the [MoDOT Location Book](#) or the [MoDOT Interactive Mapping Tool](#) MUST be used to obtain the appropriate numerical value assigned to the specific junction. See diagram in [Appendix E, page 194](#).

- **Ramps** – [Ramps](#) may only be used in the "Intersecting" field if the crash did not occur on a ramp. Crashes occurring on a ramp must be measured to the nearest intersecting roadway (other than a ramp) or bridge.
- **Bridge** – When using a bridge in the "Intersecting" field, the word "BRIDGE" and the bridge number are required (BRIDGE A2601). When locating crashes on or referenced to a bridge, the bridge number on the [MoDOT Location Book](#) or the [MoDOT Interactive Mapping Tool](#) identifies the beginning of the bridge structure in conjunction with the direction of the roadway. Therefore, crashes must be measured to the BEGINNING (not the middle or end) of a bridge structure as it relates to the roadway direction entered in the "Rdwy. Dir." field. The bridge structure does not include any attached guardrail or crash barriers.

**Bridge names must not be used in locating the crash** (i.e., Poplar Street Bridge, Paseo Bridge, Missouri River Bridge, Mississippi River Bridge, etc.). If needed, the bridge name may be included in [Section 6 - Collision Diagram](#) and/or [Section 9 - Narrative / Statements](#).



In cases where a crash occurs on a bridge connecting to another state, the state line in the lane entering Missouri must be used as the beginning of the bridge structure.

Example: If locating a crash to the eastbound lane of an east-west roadway, the crash would be referenced to the beginning of the bridge structure in the eastbound lane. See diagram in [Appendix E, page 195](#).

- **Emergency Reference Markers (ERM)** – ERMs are located statewide on most interstate highways, along with some US highways and other numbered routes. ERMs, which are normally spaced 0.2 mile apart, can be used to locate crashes. ERMs provide the direction of travel, interstate route, milepost, and tenth of a mile location. When used, crashes should be located to the nearest ERM, which should be 528 feet (0.1 mile) or less from the crash scene. Missing ERM locations must not be used. In these cases, the nearest ERM that is not missing or the nearest roadway or bridge as listed on the [MoDOT Location Book](#) or the [MoDOT Interactive Mapping Tool](#) must be used.

**Note:** The abbreviation "ERM" must be used as a route designation when using an emergency reference marker as the "Intersecting" street, etc. in [Section 2 - Location](#) of the crash report. Emergency reference markers cannot be used in the "On" field to locate crashes.

The exact information contained on the ERM must be shown in this field. Examples:



- A crash logged to the 10.0 ERM on the westbound lanes of IS 64 (above) will be shown as "ERM West IS 64 Mile 10.0".

ON IS 64		RDWY. DIR. W	DISTANCE FROM 100	LOCATION <input type="checkbox"/> NA <input checked="" type="checkbox"/> After <input type="checkbox"/> Before <input type="checkbox"/> At	INTERSECTING ERM West IS 64 Mile 10.0
SPEED LIMIT 70	ROAD MAINTAINED BY <input checked="" type="checkbox"/> State <input type="checkbox"/> County <input type="checkbox"/> Municipal <input type="checkbox"/> Private Property <input type="checkbox"/> Other		<input type="checkbox"/> Feet <input type="checkbox"/> Miles		SPEED LIMIT INT. DIR. GEO - CODE NA NA NA



- A crash logged to the 220.4 ERM on the westbound lanes of IS 70 (above) will be shown as "ERM West IS 70 Mile 220.4".

ON IS 70		RDWY. DIR. W	DISTANCE FROM 50	LOCATION <input checked="" type="checkbox"/> After <input type="checkbox"/> Before <input type="checkbox"/> At	INTERSECTING ERM West IS 70 Mile 220.4
SPEED LIMIT 70	ROAD MAINTAINED BY <input checked="" type="checkbox"/> State <input type="checkbox"/> County <input type="checkbox"/> Municipal <input type="checkbox"/> Private Property <input type="checkbox"/> Other		<input type="checkbox"/> Feet <input type="checkbox"/> Miles		SPEED LIMIT INT. DIR. GEO - CODE NA NA NA

**Note:** Bridge numbers, ERMs, and junction values can only be used in the "Intersecting" field.

**Private Property Crashes** – Locate private property crashes by street address; if no address can be determined, use the most descriptive method possible. In those cases where the "Location" and "Roadway Direction" fields are inappropriate, mark or enter "NA."

Example #1: A crash occurs in a large parking lot at 2487 Williamsburg Blvd. in front of the Wal-Mart building entrance, 157 feet west of Williamsburg Blvd. Complete these fields in the following manner:



ON PP Parking Lot at 2487 Williamsburg BLVD		RDWY. DIR. NA	DISTANCE FROM 157 <input type="checkbox"/> NA Feet	LOCATION <input type="checkbox"/> After <input checked="" type="checkbox"/> NA <input type="checkbox"/> Before <input type="checkbox"/> At	INTERSECTING West of CST Williamsburg BLVD
SPEED LIMIT NA	ROAD MAINTAINED BY <input type="checkbox"/> Unknown <input type="checkbox"/> State <input type="checkbox"/> County <input type="checkbox"/> Municipal <input checked="" type="checkbox"/> Private Property <input type="checkbox"/> Other		_____ Miles		SPEED LIMIT NA
					INT. DIR. NA
					GEO - CODE NA

(See Examples in [Appendix E, page 200.](#))

Example #2: A crash occurs on an unnamed private road between two fescue fields 210 feet north of Route V and 1.2 miles west of Route F. There is no known address for the location. Complete these fields in the following manner:

ON PP Unnamed Private Road		RDWY. DIR. NA	DISTANCE FROM 210 <input type="checkbox"/> NA Feet	LOCATION <input type="checkbox"/> After <input checked="" type="checkbox"/> NA <input type="checkbox"/> Before <input type="checkbox"/> At	INTERSECTING North of RT V, 1.2 miles West of RT F
SPEED LIMIT NA	ROAD MAINTAINED BY <input type="checkbox"/> Unknown <input type="checkbox"/> State <input type="checkbox"/> County <input type="checkbox"/> Municipal <input checked="" type="checkbox"/> Private Property <input type="checkbox"/> Other		_____ Miles		SPEED LIMIT NA
					INT. DIR. NA
					GEO - CODE NA

(See Example in [Appendix E, page 200.](#))

Example #3: A crash occurs on a privately maintained road, Jake's Lane. Jake's Lane is a north-south roadway and the crash occurred in the northbound lane, 300 feet south of Jones Circle. Jones Circle is an east-west roadway. Both roadways may or may not be found on the [MoDOT Location Book](#) or the [MoDOT Interactive Mapping Tool](#).

ON PVT Jake's LN		RDWY. DIR. N	DISTANCE FROM 300 <input type="checkbox"/> NA Feet	LOCATION <input type="checkbox"/> After <input type="checkbox"/> NA <input checked="" type="checkbox"/> Before <input type="checkbox"/> At	INTERSECTING PVT Jones CIR
SPEED LIMIT NA	ROAD MAINTAINED BY <input type="checkbox"/> Unknown <input type="checkbox"/> State <input type="checkbox"/> County <input type="checkbox"/> Municipal <input checked="" type="checkbox"/> Private Property <input type="checkbox"/> Other		_____ Miles		SPEED LIMIT NA
					INT. DIR. E
					GEO - CODE NA

(See Example in [Appendix E, page 205.](#))

- k. **SPEED LIMIT** – ("On" Roadway Speed Limit) Enter the posted speed limit pertaining to the "On" roadway. Advisory speed signs (black and yellow in color) must not be used.

**Note:**

- The speed limit on a [ramp](#) is the same as that of the [roadway](#) the ramp is exiting. For example, a ramp exiting IS 70 to US 54 would have the same limit as IS 70 (70 mph). A ramp exiting US 54 to IS 70 would have the same limit as US 54 at that location (45 mph).

- l. **ROADWAY MAINTAINED BY** – Enter an "X" in the appropriate box indicating who maintains the [roadway](#) shown in the "On" field. Interstate and most U.S. highways, including their ramps, are state-maintained roadways. Use "Other" for crashes on roadways maintained by the Corps of Engineers, National Forest Service, or any other federally owned property.

- Unknown** – Mark if it cannot be determined who maintains the roadway.
- State** – Mark if an entity of Missouri state government maintains the roadway. This includes MoDOT along with any other state agency such as the Department of Natural Resources, Department of Conservation, state university, etc.
- County** – Mark if the county where the crash occurred maintains the [roadway](#). This includes special road districts.
- Municipal** – Mark if the municipality where the crash occurred maintains the roadway.
- Private Property** – Mark if the roadway is maintained by a private entity.
- Other** – Mark if the [roadway](#) is not private property and is not maintained by the state, county, or municipality. This includes roadways maintained by a federal agency such as the Corps of Engineers and National Park Service. Explain in [Section 9 - Narrative / Statements](#).

- m. **SPEED LIMIT** – (Intersecting Speed Limit) When a crash occurs within an [intersection](#), enter the posted speed limit pertaining to the intersecting street or roadway. Enter "NA" when the crash does not occur within an intersection.

**Note:**

- The speed limit on a **ramp** is the same as that of the **roadway** the ramp is exiting. For example, a ramp exiting IS 70 to US 54 would have the same limit as IS 70 (70 mph). A ramp exiting US 54 to IS 70 would have the same limit as US 54 at that location (45 mph).
- n. **INT. DIR.** – (Intersecting Direction) Enter the direction (N, S, E, or W) of the **roadway** lane entered in the "Intersecting" field to which the crash is being referenced. For example, if measuring to the northbound lane of a north-south roadway, enter "N". See examples in [Appendix E, page 158](#). Enter "NA" if the crash is referenced to an **ERM** or bridge and not to a roadway or if the on-street designator is PP.
- o. **GEO CODE** – Enter appropriate crash location geo-code if required by agency.
- p. **TRAFFICWAY** – Mark to best describe **trafficway** configuration at crash location.
  - i. **One-Way** – **Roadway** in which movement of **motor vehicles** is allowed only in one direction.
  - ii. **Two-Way; Not Divided; Continuous Center Turn Lane** – Roadway that has a continuous two-way left-turn lane in the center for left turns and one or more lanes in opposite directions for through traffic.



(Source: MoDOT).

- iii. **Two-Way; Not Divided** – **Roadway** that is not divided and in which movement of motor vehicles is allowed in opposite directions.



(Source: MoDOT).

- iv. **Two-Way; Divided; Unprotected Median** – **Trafficway** that has one **roadway** with one or more lanes in which traffic goes one direction and another roadway with traffic going in opposite direction, and in which the two roadways are divided by a **median** that is open and without any type of protective barrier.



- v. **Two-Way; Divided; Positive Median Barrier** – **Trafficway** that has one **roadway** with one or more lanes in which traffic goes one direction and another roadway with traffic going in opposite direction, and in which the two roadways are divided by any protective concrete, metal, or other type of longitudinal manufactured barrier.



**Cable Barrier**

(Source: MMUCC).



- vi. **Other** – Mark if the **trafficway** configuration is not described above and for private property crashes not on a trafficway. Describe in [Section 9 - Narrative / Statements](#).
- vii. **Unknown** – Mark if the **trafficway** configuration at the crash scene is unknown. Explain in [Section 9 - Narrative / Statements](#). "Unknown" cannot be marked if the crash was investigated at the scene.

q. **ROADWAY ALIGNMENT** – The alignment of the **roadway** at the crash location.

- i. **Straight** – Mark if the roadway alignment was straight.
- ii. **Curve** – Mark if the roadway alignment was a curve.
- iii. **Unknown (Explain)** – Mark if the **roadway** alignment is unknown. Explain in [Section 9 - Narrative / Statements](#). "Unknown" cannot be marked if the crash was investigated at the scene.

**Note:** In the case of a private property crash, choose the roadway alignment that best describes the crash location.

r. **ROADWAY PROFILE** – The characteristics of the "On" **roadway** as related to the direction entered in the "Rdwy. Dir." field. Mark one box to indicate whether the roadway was:

- i. **Level** – Predominantly flat section of roadway. No inclination of the roadway.
- ii. **Uphill** – Upward inclination of the roadway.
- iii. **Downhill** – Downward inclination of the **roadway**.
- iv. **Hillcrest** – The top section of a hill or bridge where the grade transitions from an upgrade to a downgrade.
- v. **Dip** – The bottom section of a hill or bridge where the grade transitions from a downgrade to an upgrade. Also known as a "sag."
- vi. **Unknown (Explain)** – Mark if the roadway profile is unknown and explain in [Section 9 - Narrative / Statements](#). "Unknown" cannot be marked if the crash was investigated at the scene.

**Note:** In the case of a private property crash, choose the roadway profile that best describes the crash location.

s. **INTERSECTION TYPE** – If the crash is located at an [intersection](#) as defined in the glossary ([page 15](#)), identify the intersection type. See examples in [Appendix E, page 167](#).

i. **NA** – Mark if "Location" field is shown as "After," "Before," or "NA." Also, mark if "Location" is "At" and the route designation for the "Intersecting" field is BRIDGE or [ERM](#). See examples in [Appendix E, page 158](#).

ii. **PERPENDICULAR**



Cross-Intersection (4-way)

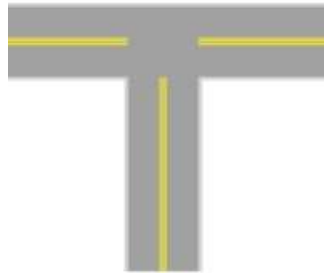

T-Intersection

iii. **ANGLED / SKEWED**



Y-Intersection



Five or More Legs and Not Circular

iv. **ROUNDAABOUT / TRAFFIC CIRCLE**



Roundabout



Other Circular Intersections

- v. **Other (Explain)** – Mark if the crash is located within an intersection not described above. Explain in [Section 9 - Narrative / Statements](#).
- vi. **Unknown (Explain)** – Mark "Unknown" and explain in [Section 9 - Narrative / Statements](#) if the information is not known. "Unknown" cannot be marked if the crash was investigated at the scene.
- t. **ROADWAY CONDITION** – The [roadway](#) surface condition at the time and place of the crash. Up to two codes can be entered. Selections should be made without regard to whether or not the roadway surface conditions contributed to the cause of the crash. Use the codes listed in [Section 8 - Codes](#). For a description of the codes, refer to [Section 8 - Codes](#) in this manual (*page 102*).
- u. **LIGHT CONDITION** – The type / level of light that existed at the time of the crash. Only one code can be entered. Use the codes listed in [Section 8 - Codes](#). For a description of the codes, refer to [Section 8 - Codes](#) in this manual (*page 103*).
- v. **ROADWAY SURFACE** – Indicates the primary surface of the [roadway](#) at the crash location. Only one code can be entered. Use the codes listed in [Section 8 - Codes](#). For a description of the codes, refer to [Section 8 - Codes](#) in this manual (*page 103*).
- w. **WEATHER / ENVIRONMENTAL CONDITIONS** – The prevailing weather, environmental, or atmospheric condition(s) that existed at the time of the crash. Up to three codes can be entered. Selections should be made without regard to whether or not the conditions contributed to the cause of the crash. Use the codes listed in [Section 8 - Codes](#). For a description of the codes, refer to [Section 8 - Codes](#) in this manual (*page 104*).

### III. SECTION 3 – DAMAGE TO PROPERTY OTHER THAN VEHICLES

List all damaged property not qualifying for entry in *Section 7 - Drivers, Vehicles, Owners, & Occupants*. If additional space is needed, record additional property damage, owners, etc., in Section 9 - Narrative / Statements. The object and ownership are more important than the amount of damage.

Includes (but is not limited to):

- Injury to domestic animals that have monetary value.
- Damage to trees, shrubs, crops, or property of determinable value.
- Government property such as highway signs, guard rails, lamp poles, etc.
- Damage to a [pedalcycle](#) with or without a [pedalcyclist](#).
- Damage to a [personal conveyance](#) without or without a [pedestrian](#).
- Injury to an animal being ridden by a person.
- Injury and damage to an animal drawn conveyance with or without a person(s).
- Damage to an [other transport device](#) occupied by an [other non-motorist](#).

Excludes:

- Property that is in or on a [motor vehicle](#) or [railway vehicle](#).
- Property that has fallen from a motor vehicle or railway vehicle in-transport but has not come to rest.

3 — DAMAGE TO PROPERTY OTHER THAN VEHICLES <input type="checkbox"/> None
LIST OWNER'S NAME & ADDRESS, DESCRIPTION OF PROPERTY, AND DAMAGE. <input type="checkbox"/> MoDOT <input type="checkbox"/> County <input type="checkbox"/> Municipality

- NONE** – Mark if there is no [damage](#) to property other than what is shown in *Section 7 – Drivers, Vehicles, Owners, & Occupants*.
- MODOT** – Mark and list description and [damage](#) sustained if the property is owned by the Missouri Department of Transportation. MoDOT's address is not necessary.
- COUNTY** – Mark and list description and [damage](#) sustained if the property is owned by the county in which the crash occurred. The county's address is not necessary.
- MUNICIPALITY** – Mark and list description and [damage](#) sustained if the property is owned by the municipality in which the crash occurred. The municipality's address is not necessary.
- OWNER'S NAME AND ADDRESS** – Enter owner's name and address (street, city, state, zip). This is not necessary if "MoDOT" is marked and there is no other personal property damaged. The name, but not the address, is required when "County" or "Municipality" is marked.
- DESCRIPTION OF PROPERTY** – Describe property damaged as a result of the crash.
- DAMAGE** – Enter the nature of the property [damage](#) (i.e., utility pole broken, 8 feet of guardrail damaged, 10 feet of fence and two fence posts damaged, etc.).

#### IV. SECTION 4 – WITNESS

Complete this section with information pertaining to persons who witnessed the crash.

4 – WITNESS <input type="checkbox"/> None Identified <input type="checkbox"/> Additional Witnesses In Narrative	
NAME & ADDRESS (Street, City, State, Zip)	PHONE NUMBER

- a. **NONE IDENTIFIED** – Mark if no witnesses are identified.
- b. **ADDITIONAL WITNESSES IN NARRATIVE** – Mark and list additional witnesses in [Section 9 - Narrative / Statements](#) if there are more witnesses than space provided.
- c. **NAME** – Enter the current legal name of witness. Begin with either the first or last name.
- d. **ADDRESS** – Enter the witness's current address (street, city, state, and zip).
- e. **PHONE** – Enter the witness's telephone number, including the area code.

## V. SECTION 5 – NON-MOTORIST (NOT OCCUPANT OF RAILWAY OR MOTOR VEHICLE)

Complete this section with information pertaining to **non-motorists** (pedestrians, pedalcyclists and other non-motorists) involved in the crash. Use the *Non-Motorists / Occupants Continuation / Supplement* if more than one non-motorist is involved.

**Note:** It is important to ascertain exactly where the person was located in relationship to their transition into or out of the **vehicle, pedalcycle, or other transport device**. Once the **unstabilized situation** begins, a pedestrian, pedalcyclist, or non-motorist remains as such until the crash **stabilizes**.

- If a person is on his/her feet, they should be considered a **pedestrian**.
- If a person is entering or exiting a vehicle or other transport device, or getting onto or off of a pedalcycle, ensure they have successfully completed the transition from pedestrian to **occupant** or vice-versa.

Examples of **Pedestrian**:

- A driverless vehicle begins to roll down a driveway. A person outside the vehicle tries to enter the driver's door but falls out before getting into the driver's seat.
- A pedestrian grabs onto the door handle to enter a stopped vehicle. In an attempt to flee, the driver accelerates the vehicle dragging the pedestrian 300 feet.
- A **school bus** is dropping off children. A child steps off the bus and her coat gets caught in the bus door when it closes. The bus begins to pull away and drags the child, causing fatal injury.
- A person is on his/her feet guiding a team of horses harnessed to a conveyance.
- A person pushing a **pedalcycle**.
- A person has one foot on the ground and one foot on the step of a road grader when the grader starts to roll forward.

5 — <b>NON-MOTORIST</b> <input type="checkbox"/> NA <input type="checkbox"/> Pedestrian <input type="checkbox"/> Prior Motor Vehicle Occupant <input type="checkbox"/> Yes <input type="checkbox"/> No		<input type="checkbox"/> Pedestrian on Personal Conveyance <input type="checkbox"/> Personal Conveyance Type (Enter Code) _____		<input type="checkbox"/> Pedalcyclist <input type="checkbox"/> On Motorized Pedalcycle <input type="checkbox"/> No <input type="checkbox"/> Gas <input type="checkbox"/> Electric <input type="checkbox"/> Other (Explain)		<input type="checkbox"/> Other Non-Motorist <input type="checkbox"/> Occupant of Animal or Animal Drawn Device <input type="checkbox"/> Yes <input type="checkbox"/> No		PEDESTRIAN SPECIAL FUNCTION <input type="checkbox"/> NA <input type="checkbox"/> Law Enforcement Officer <input type="checkbox"/> Fire <input type="checkbox"/> MoDOT Worker <input type="checkbox"/> Tow Operator <input type="checkbox"/> Other Trafficway Worker <input type="checkbox"/> EMS	
NO. NAME (Last, First, MI) & ADDRESS (Street, City, State, Zip)								PHONE NUMBER	
DATE OF BIRTH		SEX	STRUCK BY VEH#:	INJ	TRANSPORT	SAFETY DEVICES	LOCATION <input type="checkbox"/> In Driveway Access <input type="checkbox"/> On Roadway Within Crosswalk / Intersection <input type="checkbox"/> On Roadway Outside Crosswalk / Intersection <input type="checkbox"/> On Median / Separator / Crossing Island <input type="checkbox"/> On Sidewalk / Shoulder / Roadside	<input type="checkbox"/> Non-Trafficway Area <input type="checkbox"/> Shared-Use Path or Trail <input type="checkbox"/> Other (Explain) <input type="checkbox"/> Unknown	BICYCLE LANE / FACILITY (Enter Code)
CROSSING ROAD <input type="checkbox"/> NA <input type="checkbox"/> With Signal <input type="checkbox"/> Against Signal <input type="checkbox"/> No Signal <input type="checkbox"/> With Flashing Beacon <input type="checkbox"/> Unknown		<input type="checkbox"/> Intersection—Marked Crosswalk <input type="checkbox"/> Intersection—Unmarked Crosswalk <input type="checkbox"/> Midblock—Marked Crosswalk <input type="checkbox"/> Midblock—No Crosswalk <input type="checkbox"/> Unknown		ACTIONS <input type="checkbox"/> NA / None <input type="checkbox"/> Getting On / Off Vehicle <input type="checkbox"/> Standing / Lying / Sitting In Trafficway <input type="checkbox"/> Pushing / Working On Vehicle <input type="checkbox"/> Behind / In Front of Parked / Stopped Veh.		<input type="checkbox"/> Working In Trafficway <input type="checkbox"/> Playing In Trafficway <input type="checkbox"/> Walking / Running / Cycling / Riding In Trafficway <input type="checkbox"/> With Traffic <input type="checkbox"/> Against Traffic		ORIGIN / DESTINATION <input type="checkbox"/> NA <input type="checkbox"/> Going To / From School <input type="checkbox"/> Getting On / Off School Bus <input type="checkbox"/> Both Of The Above <input type="checkbox"/> Going To / From Transit <input type="checkbox"/> Unknown (Explain)	
PROBABLE CONTRIBUTING CIRCUMSTANCES <input type="checkbox"/> None <input type="checkbox"/> Failed To Yield <input type="checkbox"/> Alcohol <input type="checkbox"/> Drugs <input type="checkbox"/> Vision Obstructed (Explain) <input type="checkbox"/> Physical Impairment (Explain) <input type="checkbox"/> Not Visible (Dark Clothing, No Lighting, etc.) <input type="checkbox"/> Improper Turn		<input type="checkbox"/> Improper Passing <input type="checkbox"/> Improper Signal <input type="checkbox"/> Improper Backing <input type="checkbox"/> Distracted / Inattentive (if marked, fill in Codes) →		<input type="checkbox"/> Following Too Close <input type="checkbox"/> Improper Start from Park <input type="checkbox"/> In Roadway Improperly (Standing, Lying, Working, Playing, Stopped)		DISTRACTED / INATTENTIVE CODE(S) <input type="checkbox"/> NA		ALCOHOL USE <input type="checkbox"/> Yes <input type="checkbox"/> No <input type="checkbox"/> Unknown	

- NA** – Mark if there is no **non-motorist** involved in the crash.
- PEDESTRIAN** – Mark if the **non-motorist** involved in the crash is a **pedestrian**.

**Prior Motor Vehicle Occupant** – Indicates if a pedestrian involved in the crash was a previous occupant of a **motor vehicle** just prior to their involvement in the motor vehicle crash.

**Yes** – Mark if the **pedestrian** was a **motor vehicle occupant** whose planned travel was interrupted by an event resulting in their decision to become a pedestrian prior to the crash event.

Includes (but is not limited to) an **occupant** that exits a motor vehicle:

- To repair a flat tire.
- Due to the vehicle running out of gas or having a mechanical issue.



- Being involved in a previous crash.
- To assist another motorist involved in an incident.

Excludes:

- **Pedestrians** who are serving a special function / activity, such as law enforcement, fire, EMS, tow operator, MoDOT worker, or other trafficway worker. Exiting a **motor vehicle** is typically part of their special function / activity.

**No** – Mark if the **pedestrian** was a **motor vehicle occupant** whose choice to be a pedestrian was decided as part of their trip and not influenced by an unplanned event. Also, mark if the pedestrian was not a prior motor vehicle occupant or was serving a special function / activity.

Includes (but is not limited to) an occupant that exits a **motor vehicle**:

- At a school drop off location or to walk to school.
- Run for exercise.
- From a designated parking location and walk to work or transit.
- To hitchhike.
- To serve a special function / activity such as law enforcement, fire, EMS, tow operator, MoDOT worker, or other trafficway worker.

Also:

- A **pedestrian** who was not a prior motor vehicle occupant.

- c. **PEDESTRIAN ON PERSONAL CONVEYANCE** – Mark if the **pedestrian** was in or on a **personal conveyance** at the time of the crash.

**Personal Conveyance Type (Enter Code)** – Enter one code that best depicts the type of personal conveyance the pedestrian was in or on at the time of the crash. Use the codes listed in **Section 8 - Codes**. For a description of the codes, refer to **Section 8 - Codes** in this manual (page 112).

- d. **PEDALCYCLIST** – Mark if the **non-motorist** was on a **pedalcycle** when the crash occurred. This includes operators and passengers of the pedalcycle as well as a person being pulled by a pedalcycle (e.g., in a bike trailer, wagon, etc.).

#### **On Motorized Pedalcycle**

- i. **No** – Mark if the pedalcycle was not motorized and could be propelled only by pedaling.
  - ii. **Electric** – Mark if the pedalcycle was motorized by an electric motor allowing it to be propelled by pedaling and/or the electric motor.
  - iii. **Gas** – Mark if the pedalcycle was motorized by a gas motor allowing it to be propelled by pedaling and/or the gas motor.
  - iv. **Other (Explain)** – Mark if the pedalcycle was motorized by a motor that is not fully electric or gas allowing it to be propelled by pedaling and/or the motor. For instance, a hybrid motor that is both gas and electric powered.
- e. **OTHER NON-MOTORIST** – Mark if the **non-motorist** involved in the crash is an "**other non-motorist**."

#### **Occupant of Animal or Animal Drawn Device**

- i. **Yes** – Mark if the other non-motorist was in or on an animal or animal drawn vehicle / device at the time of the crash.

- ii. **No** – Mark if the other non-motorist was not in or on an animal or animal drawn vehicle / device at the time of the crash.
- f. **PEDESTRIAN SPECIAL FUNCTION** – Identifies [pedestrians](#) involved in the crash that are engaged in a specific function or activity. This does not apply to [pedalcyclists](#) or [other non-motorists](#).
- i. **Law Enforcement Officer** – Mark if a sworn on-duty law enforcement officer acting in an official capacity is the listed pedestrian involved in the crash. This does not include civilian or off-duty law enforcement personnel.
  - ii. **Tow Operator** – Mark if any on-duty tow operator personnel acting in an official capacity is the listed pedestrian involved in the crash.
  - iii. **EMS** – Mark if any on-duty EMS personnel acting in an official capacity is the listed [pedestrian](#) involved in the crash. Includes full-time, part-time, and volunteer. This does not include off-duty EMS personnel.
  - iv. **Fire** – Mark if any on-duty fire personnel acting in an official capacity is the listed pedestrian involved in the crash. Includes full-time, part-time, and volunteer. Fire department personnel performing EMS activities would still be considered fire personnel. This does not include off-duty fire personnel.
  - v. **MoDOT Worker** – Mark if any on-duty Missouri Department of Transportation worker acting in an official capacity is the listed [pedestrian](#) involved in the crash.
  - vi. **Other Trafficway Worker** – Mark if any other on-duty trafficway worker acting in an official capacity is the listed pedestrian involved in the crash. This includes county and municipality highway workers along with contract highway workers. Workers not associated with repairs, construction, or maintenance to the trafficway are excluded, i.e., utility workers, adopt-a-highway volunteers, etc.
  - vii. **NA** – Mark if no [pedestrian](#) is involved in the crash, or the pedestrian involved in the crash does not meet any of the above specific functions or activities.
- g. **NO.** – The unique number assigned to the [non-motorist](#) ([pedestrian](#), [pedalcyclist](#), or [other non-motorist](#)).
- h. **NAME (LAST, FIRST, MI)** – Enter the [non-motorist's](#) name. Enter individual's current legal name using last name, first name, and middle initial format. **Note:** Do not enter a period after an initial. Enter "Unknown" if the name cannot be determined.
- i. **ADDRESS (STREET, CITY, STATE, ZIP)** – Enter the [non-motorist's](#) address.
- j. **PHONE NUMBER** – Enter the non-motorist's telephone number, including the area code.
- k. **DATE OF BIRTH** – Enter the [non-motorist's](#) date-of-birth in the month, day, and year (mm-dd-yyyy) format. Enter "Unk" if unknown.
- l. **SEX** – Enter "M" for Male, "F" for Female, or "U" if the information is unknown.
- m. **STRUCK BY VEH #:** – Enter the unique number assigned to the first motor vehicle that struck the [non-motorist](#). If one person is pushed into another person, identify the vehicle that struck the first person for both non-motorists.
- n. **INJ** – (Injury) Enter one code to indicate the [non-motorist's injury](#) severity. Use the codes listed in [Section 8 - Codes](#). For a description of the codes, refer to [Section 8 - Codes](#) in this manual ([page 107](#)).

**Note:** Injuries should be classified on the basis of conditions at the scene of the crash. The exception to this rule applies to fatal injuries (*late death*). Injuries that do not meet these criteria may be documented in *Section 9 - Narrative / Statements*. Enter "5" (No Apparent Injury) for non-motorists who are not injured but transported from the scene to a medical facility for precautionary measures. Explain in *Section 9 - Narrative / Statements*.

- o. **TRANSPORT** – Enter one code to indicate whether and how the *non-motorist* was transported from the scene to a medical facility for treatment of crash-related *injuries*. Use the codes listed in *Section 8 - Codes*. For a description of the codes, refer to *Section 8 - Codes* in this manual (*page 108*).

List the name of the transporting agency or person, and medical facility they were transported to in *Section 9 - Narrative / Statements* if applicable.

**Note:** Enter "1" (No) for *non-motorists* who are not injured but transported from the scene to a medical facility for precautionary measures. In addition, mark "No" if a non-motorist deceased at the scene is transported. In either case, explain in *Section 9 - Narrative / Statements*.

- p. **SAFETY DEVICES** – Enter up to three codes to indicate the type of *safety device(s)* used, if any, by the *non-motorist*. If only one safety device is applicable, then leave the second and third safety device fields blank. Use the codes listed in *Section 8 - Codes*. For a description of the codes, refer to *Section 8 - Codes* in this manual (*page 110*). Enter "2" if no safety device was used.
- q. **LOCATION** – The location of the *non-motorist* with respect to the *trafficway* at the time they were struck. Mark the box that best represents the non-motorist location. Only one option can be marked / selected.
  - i. **On Roadway Within Crosswalk / Intersection** – The non-motorist was on the *roadway* and within a crosswalk or *intersection*.
  - ii. **On Sidewalk** – The non-motorist was on a sidewalk when struck. This does not include a non-motorist in a crosswalk.
  - iii. **In Driveway Access** – The *non-motorist* was in the access to a driveway when struck.

A driveway access is a portion of the *trafficway* at the end of a *driveway* providing access to property adjacent to a trafficway. This includes entrances to private residences, entrances to a gas station, and sidewalks which cross over a driveway access. It excludes any area not within a trafficway.

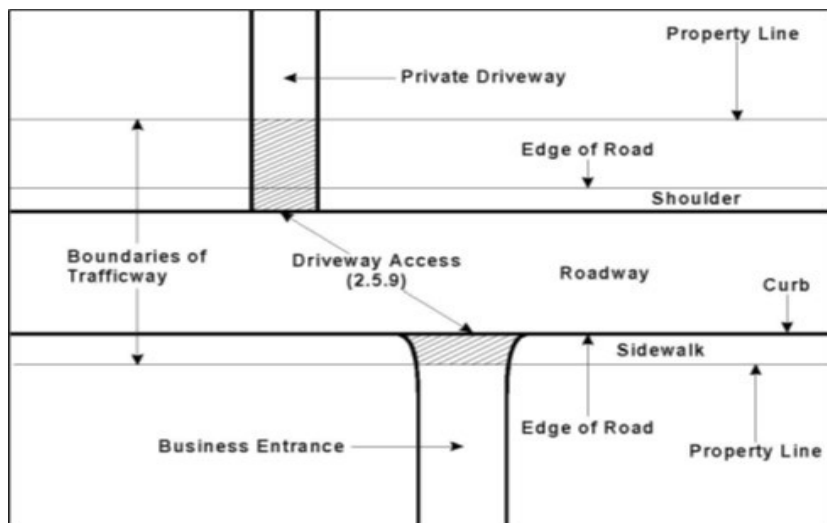

(Source: ANSI D.16 - 2017 Manual on Classification of Motor Vehicle Crashes, 8<sup>th</sup> Edition).

iv. **On Roadway Outside Crosswalk / Intersection**– The [non-motorist](#) was on the [roadway](#), but **not** within a [crosswalk](#) or [intersection](#) when struck.

v. **On Median / Separator / Crossing Island** – The non-motorist was either in a median, separator, or on a crossing island when struck.

A median is an area of [trafficway](#) between parallel [roads](#) separating travel in opposite directions. Flush or painted medians should be 4 or more feet wide between inside [roadway](#) edge lines. Medians less than 4 feet wide shall have a barrier to be considered a median. Continuous left turn lanes are not considered painted medians.

A separator is an area of the trafficway between parallel roads separating travel in the same direction or separating a frontage road (outer or service road) from other roads. A crossing island is a concrete or grassy area in the [trafficway](#) that is used by non-motorists when crossing the [roadway](#).

vi. **Shoulder / Roadside** – The [non-motorist](#) was on the shoulder or roadside when struck.

Shoulder is that part of a [trafficway](#) contiguous with the roadway for emergency use, for accommodation of stopped motor vehicles, and lateral support of the roadway structure.

Roadside is the outermost part of the trafficway from the property line or other boundary into the edge of the first road. For non-motorists on a sidewalk that is located on the roadside, select "On Sidewalk."

vii. **Non-Trafficway Area** – The non-motorist was not physically located on any area / component of the trafficway when struck. For example: a person in a [parking stall](#) of a [parking lot](#), a yard, a person in a closed portion of a work zone, or in a house.

viii. **Shared-Use Path or Trail** – The [non-motorist](#) was on a shared-use path or trail when struck. A shared-use path or trail is a bikeway physically separated from motor vehicle traffic by an open space or barrier. They may also be used by [pedestrians](#), skaters, wheelchair users, joggers, and other non-motorized users. Most have two-way travel.

ix. **Other (Explain)** – The non-motorist was at a location that is not reflected in the listed attributes of the "Location" field when they were struck. Explain in [Section 9 - Narrative / Statements](#).

x. **Unknown** – The location of the [non-motorist](#) is unknown when they were struck.

r. **BICYCLE LANE / FACILITY** – Identifies the type of bicycle lane or bicycle facility the [non-motorist](#) was in or on when struck (if applicable). Only one code can be entered. Use the codes listed in [Section 8 - Codes](#). For a description of the codes, refer to [Section 8 - Codes](#) in this manual ([page 114](#)).

A bicycle facility is any road, path, or way which is specifically designated as being open to bicycle/[pedalcycle](#) travel regardless of whether such facilities are designated for the exclusive use of bicycles/[pedalcycles](#) or are to be shared with other transportation modes.

A bicycle lane is an area adjacent to travel lanes of a [trafficway](#) which has been designated for preferential or exclusive use by [pedalcyclists](#) through striping, signage or pavement markings. It also includes a portion of [roadway](#) that has been designated by striping, pavement markings, or signs for preferential or exclusive use by [pedalcyclist](#).

s. **CROSSING ROAD** – Indicates signal and crosswalk information in regard to the [non-motorist](#) crossing the road (if applicable). Up to two selections can be made.

i. **NA** – Mark if the non-motorist was not crossing the **road** when they were struck.

ii. **Signal**

1. **With Signal** – Mark if a traffic signal was present and the non-motorist was crossing with a walk light or other signal indicating crossing was permissible when he or she was struck.
2. **Against Signal** – Mark if a traffic signal was present and the **non-motorist** was crossing with a do not walk light or other signal indicating crossing was not permissible when he or she was struck.
3. **No Signal** – Mark if no non-motorist or other traffic signal designed to indicate when crossing is permissible was present. Examples include, but are not limited to, intersections with only stop signs or flashing lights.
4. **With Flashing Beacon** – Mark if a flashing beacon was present and operating / flashing when the **non-motorist** was crossing the road. A flashing beacon is a traffic control device designed to help individuals safely cross roadways at midblock crossings and uncontrolled intersections by utilizing a flashing beacon. This beacon could be located above the roadway or on the side of the roadway.

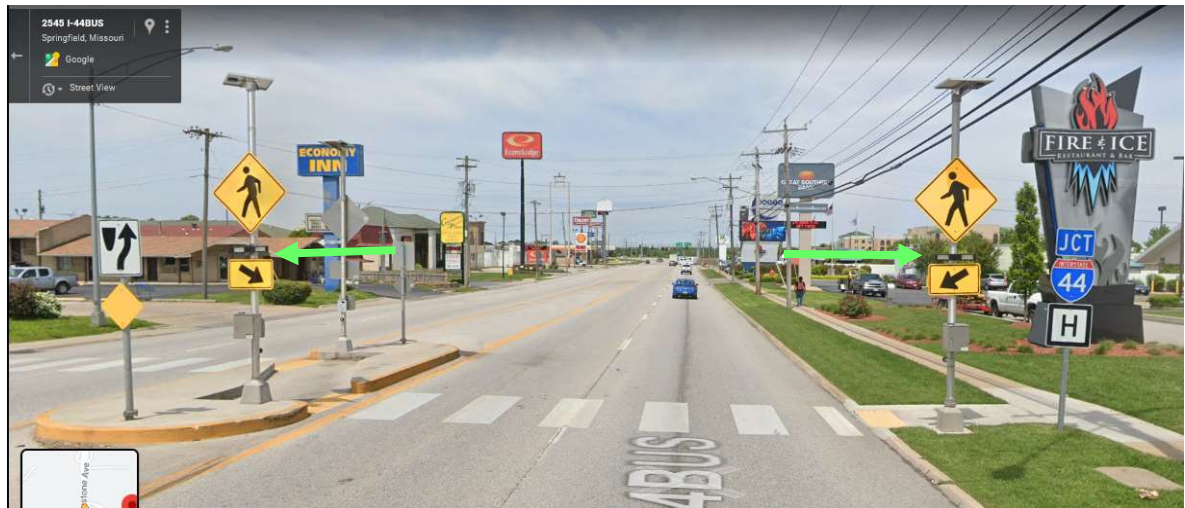

5. **Unknown** – Mark if the signal status at the time of the crash is unknown. Explain in [Section 9 - Narrative / Statements](#).

- iii. **Crosswalk**
1. **Intersection – Marked Crosswalk** – Mark if the [non-motorist](#) was crossing a [road](#) within a marked crosswalk that is at an intersection and not mid-block. A marked crosswalk is an area distinctly indicated for non-motorist crossing by lines or other markings on the surface of the road.
  2. **Intersection – Unmarked Crosswalk** – Mark if the non-motorist was crossing a road at an [intersection](#), not mid-block, in an unmarked crosswalk. This is an area that contains a crossing or connection of two or more [roadways](#) not classified as a [driveway access](#) but without distinct markings for non-motorist crossing indicated by lines or other markings on the surface of the road.
  3. **Midblock – Marked Crosswalk** – Mark if the non-motorist was crossing a [road](#) within a marked crosswalk and the crosswalk is not at an [intersection](#). A marked crosswalk is an area distinctly indicated for [non-motorist](#) crossing by lines or other markings on the surface of the [road](#).
  4. **Midblock – No Crosswalk** – Mark if the non-motorist was crossing a road at a location other than an [intersection](#) and not in a designated crosswalk (marked or unmarked).
  5. **Unknown** – Mark if it is unknown if the [non-motorist](#) was in a crosswalk. Explain in [Section 9 - Narrative / Statements](#).
- t. **ACTIONS** – Identifies other actions of the [non-motorist](#) when they were struck. Up to three selections can be made.
- i. **NA/None** – Mark if this field is not applicable to the crash.
  - ii. **Getting On / Off Vehicle** – Mark if the person was getting into or out of a vehicle, or getting on or off a vehicle. **Note:** It is important to ascertain exactly where the person was located in relationship to their transition into or out of the vehicle. Once the unstabilized situation begins, a pedestrian remains a pedestrian until the crash stabilizes. See [examples](#) on [page 54](#).
    - If a person is on his/her feet outside the vehicle, he/she is considered a pedestrian.
    - If a person is entering or exiting a vehicle, ensure he/she has successfully completed the transition from pedestrian to [occupant](#) or vice-versa.
  - iii. **Standing / Lying / Sitting in Trafficway** – Mark if the [pedestrian](#) was standing, lying, or sitting in the [trafficway](#) when struck.
  - iv. **Pushing / Working On Vehicle** – Mark if the [pedestrian](#) was pushing or working on a vehicle when struck.
  - v. **Behind / In Front of Parked / Stopped Vehicle** – Mark if the [non-motorist](#) was behind or in front of a stopped or parked vehicle when struck. Includes instances where the non-motorist appears from behind or in front of a parked or stopped vehicle.
  - vi. **Working In Trafficway** – Mark if the non-motorist was working in the [trafficway](#) when struck. This includes, but is not limited to, trafficway workers.
  - vii. **Playing In Trafficway** – Mark if the non-motorist was playing in the trafficway when struck.
  - viii. **Walking / Running / Cycling / Riding In Trafficway** – Mark if the [non-motorist](#) was walking, running, cycling, or riding in the [trafficway](#) when struck. Note: If marked, either With Traffic or Against Traffic must also be selected – see below.

- **With traffic** – Mark if the non-motorist was moving with the traffic flow when struck. (Must be selected in conjunction with Walking / Running / Cycling / Riding in Trafficway.)
    - **Against Traffic** – Mark if the **non-motorist** was moving against the traffic flow when struck. (Must be selected in conjunction with Walking / Running / Cycling / Riding in Trafficway.)
  - ix. **Other (Explain)** – The actions of the non-motorist are not reflected in the listed attributes of the “Actions” subsection when they were struck. Explain in [Section 9 - Narrative / Statements](#).
  - x. **Unknown** – Mark if the actions of the **non-motorist** are unknown when they were struck. Explain in [Section 9 - Narrative / Statements](#).
- u. **ORIGIN / DESTINATION** – Indicates the origin and destination of **non-motorists**. Attributes pertaining to school and **school buses** relates to K-12 students going to / from school or a school-sponsored event. Activities conducted on school property that are not school sponsored are excluded. For example, school property rented for antique shows, etc. This subsection also pertains to non-motorists going to or from transit such as bus stops, railway stations, etc. Only one can be marked.
- i. **NA** – Mark if this field does not apply.
  - ii. **Going To / From School** – Mark if the **non-motorist** was a K-12 student going to or from school or a school-sponsored event.
  - iii. **Getting On / Off School Bus** – Mark if the non-motorist was a K-12 student getting on or off a **school bus** associated with a school or a school-sponsored event.
  - iv. **Both of the Above** – Mark if the non-motorist is both going to or from school AND getting on or off a **school bus**.
  - v. **Going To / From Transit** – Mark if the **non-motorist** was in route to or coming from transit. This includes, but is not limited to, transit / transit rail stations, transit buses or bus stops, transit hubs, etc.
  - vi. **Unknown (Explain)** – Mark if this information is unknown and explain in [Section 9 - Narrative / Statements](#).
- v. **PROBABLE CONTRIBUTING CIRCUMSTANCES** – This field is used to record contributing circumstances to the crash on the part of the **non-motorist**. Mark all that apply. If "None," or "Unknown" are marked, then no other circumstances may be marked.
- i. **None** – Mark only if, in the investigating officer's opinion, the non-motorist did not contribute to the crash.
  - ii. **Failed to Yield** – Mark if the non-motorist failed to yield as required.
  - iii. **Failure to Obey Traffic Signs, Signals, or Officer** – Mark if the **non-motorist** failed to comply with a traffic signal or sign or the direction of an officer. Includes electric signal, stop sign, officer / flagman, yield sign, road closed sign, no passing in a work zone, etc.
  - iv. **Improper Lane Usage / Change** – Mark if improper lane usage or an improper lane change by the non-motorist contributed to the crash. This does not include instances where the non-motorist is making a turning movement. Includes changing lanes and striking another vehicle, going straight in a turn-only lane, etc.
  - v. **Alcohol** – Mark if the use of alcohol by the **non-motorist** contributed to the crash. This does not indicate intoxication, only that alcohol consumption contributed to the crash.

"Yes" under the "Alcohol Use" field must be selected if "Alcohol" is marked as a contributing circumstance.

- vi. **Drugs** – Mark if the use of drugs (legal or illegal) by the non-motorist contributed to the crash. This does not indicate intoxication or impairment, only that drug use contributed to the crash.
- vii. **Wrong Way** – Mark if the **non-motorist** was proceeding the wrong way on a one-way street or highway. For instance, a **pedalcyclist** or horse and buggy rider traveling eastbound in the westbound lanes of a divided highway.
- viii. **Vision Obstructed (Explain)** – Mark if the non-motorist's vision was obscured and this contributed to the crash. Explain in [Section 9 - Narrative / Statements](#).
- ix. **Physical Impairment (Explain)** – Mark if a physical impairment on the part of the **non-motorist** contributed to the crash. Includes fatigue, asleep, and illness. Wearing glasses and alcohol and/or drug impairment is not considered physical impairment. Explain in [Section 9 - Narrative / Statements](#).
- x. **Not Visible (Dark Clothing, No Lighting, etc.)** – Mark when the non-motorist was not visible to the motorist because of blocked views, insufficient lighting, or other reasons such as clothing which blends in with the surroundings at any time of the day (camouflage) or dark clothing in the rain at night.
- xi. **Improper Turn** – Mark if an improper turn on the part of the **non-motorist** contributed to the crash. Turning from a straight-only lane would be considered an improper turn. Do not mark in instances where a non-motorist is changing from one lane to another, but not turning.
- xii. **Improper Passing** – Mark if an improper pass (overtaking) by the non-motorist of another vehicle going the same direction contributed to the crash.
- xiii. **Improper Signal** – Mark if an improper signal by the **pedalcyclist or other non-motorist** (or no signal when required) contributed to the crash.
- xiv. **Improper Backing** – Mark if the **pedalcyclist or other non-motorist** contributed to the crash by improperly backing.
- xv. **Distracted / Inattentive** – Mark if the **non-motorist** was distracted or inattentive. A "Distraction / Inattention Code(s)" must be entered when this is marked. Use the codes listed in [Section 8 - Codes](#). For a description of the codes, refer to [Section 8 - Codes](#) in this manual (*page 115*).
- xvi. **Following Too Close** – Mark if the **pedalcyclist or other non-motorist** followed another vehicle too closely and this contributed to the crash.
- xvii. **Improper Start from Park** – Mark if the **pedalcyclist or other non-motorist** was parked and the improper start from the parked position contributed to the crash.
- xviii. **In Roadway Improperly (Standing, Lying, Working, Playing, Stopped)** – Mark if the non-motorist was on a **roadway** inappropriately, or when not directed to do so by a traffic control device or law enforcement officer.
- xix. **Other (Explain)** – Mark if another unlisted contributing factor on the part of the **non-motorist** contributed to the crash. Explain in [Section 9 - Narrative / Statements](#).
- xx. **Unknown (Explain)** – Mark if it is unknown whether actions on the part of the non-motorist contributed to the crash or if there was not enough evidence at the scene to ascertain who or what contributed. If marked, no other selections can be made. Explain in [Section 9 - Narrative / Statements](#).



- w. **DISTRACTED / INATTENTIVE CODE(S)** – This field identifies the type of distraction(s) involved when "Distracted / Inattentive" is selected as a probable contributing circumstance for the **non-motorist**. Up to four can be entered. Use the codes listed in [Section 8 - Codes](#). For a description of the codes, refer to [Section 8 - Codes](#) in this manual (*page 115*). Explain cause of the distraction or inattention in [Section 9 - Narrative / Statements](#).

**NA** – Mark if "Distracted / Inattentive" was not marked as a probable contributing circumstance.

- x. **ALCOHOL USE** – This is reflective of the investigating officer's opinion as to the use of alcohol by the **non-motorist** and is not a judgment of quantity or intoxication. Note: If, in the officer's opinion, alcohol use by the non-motorist contributed to the crash, it must be reflected in the "Probable Contributing Circumstances" field for the non-motorist.
- i. **Yes** – Use of alcohol on the part of the **non-motorist** is suspected. This must be selected if "Alcohol" is marked in the field "Probable Contributing Circumstances" for the non-motorist.
  - ii. **No** – Use of alcohol on the part of the non-motorist is not suspected.
  - iii. **Unknown** – Alcohol use on the part of the non-motorist is unknown.

## VI. SECTION 6 – COLLISION DIAGRAM

This section contains the collision diagram and fields for showing direction of travel of each vehicle prior to the crash event.

REPORT # \_\_\_\_\_ PAGE \_\_\_\_\_ OF \_\_\_\_\_

6. COLLISION DIAGRAM	Compass Direction Before Crash Event(s) (Circle One)	V1	N	E	S	W	U	V2	N	E	S	W	U	V3	N	E	S	W	U	V4	N	E	S	W	U	V5	N	E	S	W	U	V6	N	E	S	W	U
INDICATE ROAD NAMES																		INDICATE NORTH																			
DIAGRAM NOT TO SCALE																																					

### WHEN TO COMPLETE A DIAGRAM

A collision diagram **MUST** be included on all reports where enough evidence and/or facts can be obtained to adequately depict the crash scene. If a diagram is not made, write "None" in [Section 6 - Collision Diagram](#) and fully describe the crash in [Section 9 - Narrative / Statements](#).

### DIAGRAMMING METHODS

The diagramming method (template, ITE, or computer aided diagram) is a departmental decision. Do not combine template and ITE diagramming methods on the same report. Law enforcement agencies may use pre-drawn diagrams describing a specific location. It is also acceptable to use an additional separate sheet. For a listing of template and ITE symbols refer to [Appendix B, page 150](#).

- a. **COMPASS DIRECTION BEFORE CRASH EVENT(S)** - Circle one letter designating each involved vehicle's true direction of travel **PRIOR TO** the crash event(s). If a vehicle is parked or stopped, enter the direction the vehicle is facing. If a vehicle is turning, show the direction prior to the turn. Mark "U" if the information is unknown.

Example #1: If a vehicle is facing east but backing west, the direction prior to the crash event is west.

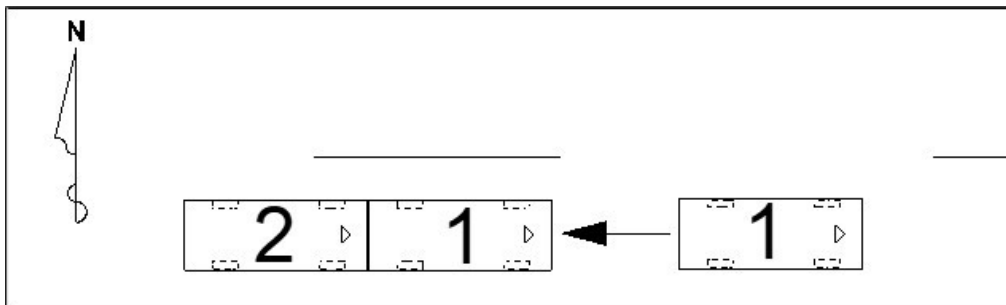

Example #2: If two vehicles are traveling opposite directions and one turns left into the path of the other, show the direction of each vehicle prior to the vehicle turning. In the example, the direction of vehicle #1 is east and the direction of vehicle #2 is west.

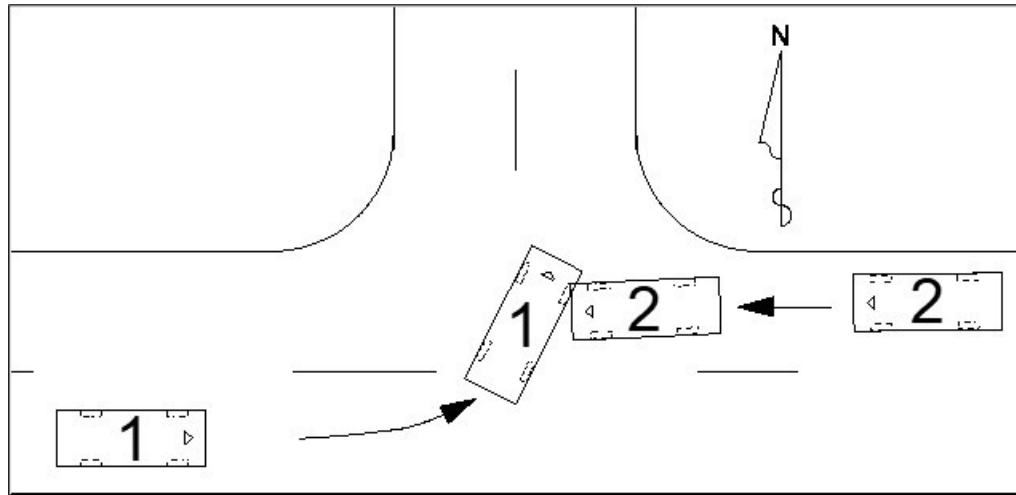

- b. **INDICATE NORTH** - Indicate north by drawing an arrow in the upper right corner.
- c. **DIAGRAM NOT TO SCALE** - If diagram is to scale, cross out "Not."

**Note:** Numbering Roadway Lanes - Engineering standards call for lane numbering on roadways with two or more lanes in the same direction to begin on the inside of the roadway next to the median or barrier and progress to the outside lanes (or to the right). This method should be used when referring to lane numbers on the diagram.

Example: Lane one of a roadway with four lanes of travel in the same direction would be the inside lane next to the median or barrier and lane four would be the outside lane next to the shoulder (or right side of the roadway). See example below.



## VII. SECTION 7 – DRIVERS, VEHICLES, OWNERS, & OCCUPANTS

This section contains information about a **motor vehicle driver** involved in the crash. It also contains pertinent information about the **motor vehicle** involved in the crash including the owner and **occupants**. Information on **working motor vehicles** should also be included when involved in a **harmful event** with a motor vehicle **in transport**. Record information on **non-motorists** in [Section 3 - Damage to Property Other than Vehicles](#) (if applicable) and [Section 5 - Non-Motorist](#).

Show train / **railway vehicle** information (including the engineer, train crew, passengers, etc.) when involved in a harmful event(s) with a motor vehicle **in transport** on the [Train Crash Continuation / Supplement](#) form.

Section 7- Drivers, Vehicles, Owners, & Occupants must be completed for each motor vehicle involved in the crash. The standard report includes two pages with this section. Additional pages with this section must be added for crashes involving more than two motor vehicles.

**PAGE NOT USED** – Mark if the second page with [Section 7 - Drivers, Vehicles, Owners, & Occupants](#) is not utilized. (This box is used primarily for hard copy crash reports versus crash reports submitted electronically to the MOCARS.) The page should be counted sequentially as part of the report; however, it is not necessary to enter "NA" in each of the fields.

Page Not Used      REPORT # \_\_\_\_\_      PAGE \_\_\_\_\_ OF \_\_\_\_\_

7 – DRIVERS, VEHICLES, OWNERS, & OCCUPANTS													
NO. 7A. DRIVER — NAME (Last, First, MI) & ADDRESS (Street, City, State, Zip)											PHONE NUMBER		
DRIVER LICENSE / ID NUMBER		STATE	LIC STATUS <input type="checkbox"/> Valid <input type="checkbox"/> Expired <input type="checkbox"/> Susp / Rev / Denied <input type="checkbox"/> Disqual CDL <input type="checkbox"/> Canceled / Oth Invalid <input type="checkbox"/> Unknown <input type="checkbox"/> NA			LIC TYPE <input type="checkbox"/> Operator Class _____ <input type="checkbox"/> CDL Class _____ <input type="checkbox"/> Interm / Grad <input type="checkbox"/> NA		<input type="checkbox"/> Permit <input type="checkbox"/> MC Only <input type="checkbox"/> Unlicensed		ENDORSEMENTS <input type="checkbox"/> Yes (add code) <input type="checkbox"/> No <input type="checkbox"/> NA <input type="checkbox"/> Unk			
DATE OF BIRTH	SEX	SEAT LOC	INJ	TRANS-PORT	EJEC-TION	AIR BAG	SAFETY DEVICES	INDICATION OF IMPROPER USE? <input type="checkbox"/> Yes <input type="checkbox"/> No <input type="checkbox"/> Unk <input type="checkbox"/> NA	VISION OBSTRUCTED <input type="checkbox"/> NA	<input type="checkbox"/> Not Obstructed	<input type="checkbox"/> Trees / Brush	<input type="checkbox"/> Sign	<input type="checkbox"/> Moving Veh <input type="checkbox"/> Other (Explain)
DRIVER LICENSE RESTRICTIONS		Alcohol Interlock Required on License? <input type="checkbox"/> Yes <input type="checkbox"/> No <input type="checkbox"/> Unknown <input type="checkbox"/> NA			Alcohol Interlock Present? <input type="checkbox"/> Yes <input type="checkbox"/> No <input type="checkbox"/> Unknown <input type="checkbox"/> NA		<input type="checkbox"/> Windshield <input type="checkbox"/> Building <input type="checkbox"/> Hillcrest <input type="checkbox"/> Embankment <input type="checkbox"/> Parked Veh <input type="checkbox"/> Glare <input type="checkbox"/> Stopped Veh <input type="checkbox"/> Unknown (Explain)						
PROOF OF INSURANCE <input type="checkbox"/> Yes <input type="checkbox"/> No <input type="checkbox"/> Not Required		INSURANCE COMPANY <input type="checkbox"/> Expired			PHONE NO. (Optional)		POLICY NUMBER <input type="checkbox"/> NA		<input type="checkbox"/> Driver <input type="checkbox"/> Vehicle				

- a. **NO.** – (Number) The **vehicle** driver or operator number assigned by the investigator.

### 7A. DRIVER (Motor vehicle driver.)

- i. **NAME (LAST, FIRST, MI)** – Enter the driver's current legal name using last name, first name, and middle initial format. **Note:** Do not enter a period after an initial. The name on the driver's license (and the Department of Revenue) may differ from the driver's current legal name.

Enter "None" if there is no driver and enter "Unk" if the driver cannot be identified.

**Note:** A person sitting in the driver's seat of a "**Parked Motor Vehicle**" is shown as an **occupant**, not a driver. The information pertaining to this person is shown in [Section 7G – Occupant Information](#).

- ii. **ADDRESS (STREET, CITY, STATE, ZIP)** – Enter the driver's most current address.
- iii. **PHONE NUMBER** – Enter the **driver's** telephone number, including the area code.
- iv. **DRIVER LICENSE / ID NUMBER** – Enter the complete driver license number or identification number from driver license / identification card regardless of the status of the license (i.e., suspended, revoked). If the individual has no license, enter the number assigned by the licensing authority if available.

Enter:

**"None"** if a license is required and the driver is unlicensed and has no assigned number.

**"Unk"** if the driver license number cannot be determined.

**"NA"** if no license is required, the driver is unlicensed, or there is no driver.

- v. **STATE** – Enter state issuing the driver license / identification card using the standard NCIC two-letter abbreviation as shown in [Appendix C - United States, Canada, and Mexico Abbreviations](#), page 155. Enter "XX" for licenses issued by entities not listed in the appendix.
- vi. **LIC. STATUS** – (License Status) Mark one box indicating the status of the driver license.

**Note:** See [Appendix G - Driver License Status and Type](#) on page 209 in reference to specific situations concerning license status and license type.

1. **NA** – Mark in the following circumstances:
  - a. A license is not required.
  - b. The **driver** is unlicensed.
  - c. There is no driver.
2. **Valid** – Mark if the **driver** is required to have a license to operate the particular vehicle and has a valid license.

Mark if an unqualified CDL holder is valid to operate a non-commercial motor vehicle and was operating a non-commercial motor vehicle in the crash.

Mark if the driver is required to have a license to operate the particular vehicle and has a valid temporary permit / privilege or valid instruction permit. This should also be marked when a motorcycle operator has a valid motorcycle permit.

3. **Suspended / Revoked / Denied** – Mark if the **driver** is required to have a license to operate the particular vehicle and has a suspended, revoked, or denied license or privilege. If applicable, select regardless of whether the operator is authorized / qualified to operate the vehicle. Example: Person is driving a motorcycle without a valid motorcycle license, permit, or endorsement and their license or privilege is suspended.
4. **Canceled / Oth. Invalid** (Canceled / Otherwise Invalid) – Mark if the **driver** is required to have a license to operate the particular vehicle and has a canceled or otherwise invalid license. This would also apply to a driver who has a valid license, however, is not qualified for the vehicle being operated at the time of the crash. "Oth. Invalid" would include failing to comply with restrictions of an intermediate or graduated license, permit, commercial driver license (CDL), etc.

This includes drivers who otherwise have a valid license, but are unqualified to operate a vehicle at the time of the crash (no endorsement for vehicle / load type.) Mark if a motorcycle operator does not have a valid motorcycle permit or endorsement at the time of the crash.

5. **Expired** – Mark if the **driver** is required to have a license to operate the particular vehicle and has an expired license that is not suspended, revoked, denied, canceled, or is otherwise invalid.
6. **Disq. CDL** – (Disqualified CDL) Mark if the **driver** is operating a **commercial motor vehicle** requiring a CDL and the driver's CDL is disqualified.
7. **Unknown** – Mark if the **driver** is required to have a license to operate the particular vehicle and license status is unknown. Explain in [Section 9 - Narrative / Statements](#).

vii. **LIC. TYPE** (License Type) – Mark one box indicating the type of driver license.

**Note:** See [Appendix G - Driver License Status and Type](#) on page 209 in reference to specific situations concerning license status and license type.

1. **NA** – Mark only if there is no **driver** or the driver is not required to have a license.
2. **Operator Class** – Mark if the driver has a driver license and not a CDL, regardless of the license status. If the driver is operating a non-CMV and the driver's CDL is canceled, the driver may have a valid operator license.
  - **Class** – Enter appropriate class code listed on the license. Missouri driver license codes shown will either be "E" or "F". Do not list endorsement or restriction codes. If a class code is not listed on an out-of-state license, write "NA." Enter "Unk" if the class is unknown.
3. **CDL Class** – Mark if the **driver** has a CDL, regardless of the license status.
  - **Class** – Enter the appropriate class code listed on the license. Missouri CDL codes are "A," "B," or "C". Do not list endorsement or restriction codes. If a class code is not listed on an out-of-state license, write "NA." Enter "Unk" if the CDL class is unknown.
4. **Interm / Grad** (Intermediate / Graduated) – Mark if the driver has an intermediate or graduated license, regardless of the license status.
5. **Permit** – Mark if the **driver** has a permit, regardless of the license status. This includes driver's license permits or a motorcycle operator with a valid motorcycle permit.
6. **MC Only** (Motorcycle Only) – Mark if the driver is licensed for a motorcycle ONLY, regardless of the license status.
7. **Unlicensed** – Mark only if the **driver** does not have a driver license or permit. Includes unlicensed drivers whose status is suspended/revoked/denied, but have been assigned a driver license number by DOR. This does not include an operator who has a driver license that is suspended, revoked, denied, canceled, expired, or disqualified. In these cases, the actual type of license issued should be marked.
8. **Unknown (Explain)** – Mark if the driver / operator is required to have a license and license type is unknown. Explain in [Section 9 - Narrative / Statements](#).

viii. **ENDORSEMENTS** – Mark the appropriate box to indicate whether the **driver** has any endorsements assigned to their driver license, both commercial and non-commercial, and enter the code(s) identifying the specific endorsement.

1. **Yes** – Mark if the **driver** has an endorsement(s) assigned to their driver license. (A code(s) must be entered identifying the type of endorsement.)
2. **No** – Mark if the driver has no endorsement(s) assigned to their driver license.
3. **NA** – Mark if there was no driver, the driver is not required to have a driver license, or the driver is unlicensed.
4. **Unk** – Mark if the **driver** is required to have a license and the type of endorsement(s) that may be assigned to their driver license is unknown. "Unk" – unknown should only be marked if License Type is marked "Unknown." Explain in [Section 9 - Narrative / Statements](#).

5. **Code(s)** – Enter up to two codes that indicates the type of endorsement(s) assigned to the driver's license. Use the codes listed in [Section 8 - Codes](#). For a description of the codes, refer to [Section 8 - Codes](#) in this manual (*page 116*).
- ix. **DATE OF BIRTH** – Enter the [driver's](#) birth date in month, day, and year (mm-dd-yyyy) format. Enter "Unk" if unknown.
- x. **SEX** – Enter "M" for male, "F" for female, "U" if the information is unknown for the driver, or "N" if there is no driver.
- xi. **SEAT LOC.** – (Seat Location) Enter the appropriate code to indicate the [driver's](#) seat location. "NA" is entered only if there was no driver. Use the codes listed in [Section 8 - Codes](#). For a description of the codes, refer to [Section 8 - Codes](#) in this manual (*page 105*).

**Note:** A person sitting in the driver's seat of a "Parked Motor Vehicle" is shown as an occupant, not a driver. The information pertaining to this person is shown in Section 7G – Occupant Information

When an occupant is sitting on the driver's lap, enter the same seat location code for both and explain in [Section 9 - Narrative / Statements](#).

- xii. **INJ** – (*Injury*) Enter one code to indicate the [driver's](#) injury severity. "N" (NA) may be entered only if there was no driver. Use the codes listed in [Section 8 - Codes](#). For a description of the codes, refer to [Section 8 - Codes](#) in this manual (*page 106*).

**Note:** Injuries should be classified on the basis of conditions at the scene of the crash. The exception to this rule applies to fatal injuries (*late death*). Injuries that do not meet these criteria may be documented in [Section 9 - Narrative / Statements](#).

Enter code "5" – (O) No Apparent Injury for drivers who are not injured but transported from the scene to a medical facility for precautionary measures. Explain in [Section 9 - Narrative / Statements](#).

- xiii. **TRANSPORT** – Enter one code to indicate whether and how the [driver](#) was transported from the scene to a medical facility for treatment of crash-related injuries. "N" (NA) may be entered only if there was no driver. Use the codes listed in [Section 8 - Codes](#). For a description of the codes, refer to [Section 8 - Codes](#) in this manual (*page 108*).

List the name of the transporting agency or person, and medical facility they were transported to in [Section 9 - Narrative / Statements](#) if applicable.

**Note:** Enter "1" (No) for drivers who were not injured but transported from the scene to a medical facility for precautionary measures. In addition, mark "No" if a person deceased at the scene was transported. In either case, explain in [Section 9 - Narrative / Statements](#).

- xiv. **EJECTION** – Enter one code to indicate whether the [driver](#) was ejected from the motor vehicle. This does not include persons falling off a vehicle. "1" (NA) may be entered only if there was no driver. Show ejection codes for all types of motor vehicles, including motorcyclist. Use the codes listed in [Section 8 - Codes](#). For a description of the codes, refer to [Section 8 - Codes](#) in this manual (*page 108*).

**Note: All Fatality Crashes** – Identify ejection path (windshield, door, T-top, etc.) of **everyone ejected in a fatality crash** in [Section 9 - Narrative / Statements](#). This is not applicable for cyclists.

- xv. **AIR BAG** – Enter up to four codes to indicate if air bags were present for the [driver](#) and whether any airbags were deployed. Use the codes listed in [Section 8 - Codes](#). For a description of the codes, refer to [Section 8 - Codes](#) in this manual (*page 109*).

- xvi. **SAFETY DEVICES** – Enter a maximum of two codes to indicate the type of [safety device](#)(s) used, if any, by the [driver](#). If only one safety device is applicable, then leave the second safety device field blank. Use the codes listed in [Section 8 - Codes](#). For a description of the codes, refer to [Section 8 - Codes](#) in this manual (*page 110*).

**Improper Use:**

1. **Yes** – Mark when the driver was using a safety device but did not use it properly as designed or intended by the manufacturer or safety standards at the time of the crash. Do not mark when the driver was **not** using a safety device.

Examples:

- A manual shoulder and lap belt restraint system was available, but only the lap belt was used and the shoulder belt portion was behind the driver's back.
- A motorcycle occupant was wearing a DOT compliant motorcycle helmet without the chin strap secured.

2. **No** – Mark when the [driver](#) was using a [safety device](#) and there was no indication of misuse at the time of the crash. (The safety device was being used as designed or intended by the manufacturer or safety standards.)
3. **Unk (Unknown)** – Mark when it is unknown if there was improper use of the safety device by the driver. "U" – Use Unknown must be entered for Safety Device.
4. **NA** – Mark if this field is not applicable. Also, mark if no safety device was used by the driver or present on the vehicle. For instance, Code 1. - None or Code 2. - Not Used was entered in the Safety Devices field for the driver.

- xvii. **VISION OBSTRUCTED** – This field identifies [driver](#) vision obstructions. Vision obstructions are anything that blocks the driver's sight, contributing to the crash. Mark all that are applicable. No other selections may be made if "NA," "Not Obstructed," or "Unknown" is marked.

1. **NA** – Mark if there was no driver, as in the case of a [parked motor vehicle](#). This may not be marked if "Vision Obstruction" is marked in [Section 7D - Probable Contributing Circumstances](#).
2. **Not Obstructed** – Mark to indicate the [driver's](#) vision was not obstructed. This may not be marked if "Vision Obstructed" is marked in [Section 7D - Probable Contributing Circumstances](#).
3. **Windshield** – Mark if defects in the windshield (e.g., broken glass) or something on the windshield such as water, mud, dirt, frost, snow, etc. obstructed the driver's vision.
4. **Load on Veh** – Mark if the load or [cargo](#) on the [driver's](#) vehicle obstructed the driver's vision.
5. **Trees / Brush** – Mark if trees, brush, or other vegetation obstructed the driver's vision.
6. **Building** – Mark if building(s) obstructed the driver's vision.
7. **Embankment** – Mark if an embankment obstructed the [driver's](#) vision.
8. **Sign** – Mark if a sign obstructed the driver's vision.
9. **Hillcrest** – Mark if a hillcrest obstructed the driver's vision.



10. **Parked Veh** – Mark if a [parked vehicle](#) obstructed the [driver's](#) vision.
11. **Moving Veh** – Mark if a moving vehicle other than the driver's vehicle, obstructed the driver's vision.
12. **Stopped Veh** – Mark if a stopped vehicle obstructed the driver's vision.
13. **Glare** – Mark if glare from the sun or other light source obstructed the [driver's](#) vision. This includes reflections.
14. **Other (Explain)** – Mark if the driver's vision was obstructed and none of the above apply. Explain in [Section 9 - Narrative / Statements](#).
15. **Unknown (Explain)** – Mark if it cannot be determined or it is unknown if the driver's vision was obstructed. Explain in [Section 9 - Narrative / Statements](#).

xviii. **DRIVER LICENSE RESTRICTIONS**

**Alcohol Interlock Required on License?** – This identifies if a breath alcohol ignition interlock device is a restriction on the driver license record / status of each respective [driver](#) involved in the crash.

1. **Yes** – Mark if an alcohol interlock device is a restriction on the driver's license record / status.
2. **No** – Mark if an alcohol interlock device is not a restriction on the driver's license record / status.
3. **Unknown** – Mark if it is unknown whether an alcohol interlock device is a restriction on the driver's license record / status. "Unknown" should only be marked if License Type is marked "Unknown." Explain in [Section 9 - Narrative / Statements](#).
4. **NA – Not Applicable** – Mark if there was no [driver](#).

**Alcohol Interlock Present?** – This identifies the presence and installation of a breath alcohol ignition interlock device on the [motor vehicle](#) the [driver](#) involved in the crash was driving/operating.

1. **Yes** – Mark if an alcohol interlock device is present and installed on the motor vehicle the driver involved in the crash was driving.
2. **No** – Mark if an alcohol interlock device is not present on the motor vehicle the [driver](#) involved in the crash was driving. Mark if an alcohol interlock device is present on the vehicle, but not installed.
3. **Unknown** – Mark if it is unknown whether an alcohol interlock device was present and installed on the [motor vehicle](#) the driver involved in the crash was driving.
5. **NA – Not Applicable** – Mark if there was no [driver](#).

xix. **PROOF OF INSURANCE** – This includes proof of insurance issued by an insurance carrier or proof of financial responsibility issued by the Missouri Department of Revenue.

1. **Yes** – Mark anytime proof of insurance or financial responsibility is shown. This is regardless of whether proof is required or not.

2. **No** – Mark when proof of insurance or financial responsibility is required, but not provided. This should be marked when an expired insurance card is provided and proof is required.
3. **Not Required** – Mark when proof is not required and is not shown.

**Note:** Proof of insurance is required for all **motor vehicles** (Missouri and out-of-state) except for **commercial motor vehicles** registered out-of-state or motor vehicles owned by government entities.

- xx. **INSURANCE COMPANY** – Enter insurance company's name as shown on proof of insurance. If proof is not required and is not shown, insurance company's name should be entered to facilitate claim processing by crash victims. "Not Required" must be marked for Proof of Insurance. If proof is not required but shown, insurance company's name should be entered to facilitate claim processing by crash victims. In such cases, Proof of Insurance should be marked "Yes". Enter "Self-Insured" if applicable.

Enter "NA" if proof is not shown (required or not).

**Expired** – Mark if expired proof of insurance is presented. The company name should still be entered in the field even if the proof of insurance is expired.

- xxi. **PHONE NO. (OPTIONAL)** – Enter insurance company's telephone number, including the area code. Enter "NA" if the information is unknown, not obtained, or this field does not apply.
- xxii. **POLICY NUMBER** – Enter insurance policy number as shown on the proof of insurance. Enter number even if expired proof of insurance is presented. Enter "Unknown" if proof is shown; however, the policy number is obliterated or unavailable.
- NA** – Mark if the **motor vehicle** or **driver** is uninsured or the driver fails to show proof of liability insurance. Do not mark "NA" if expired proof of insurance is presented.
- xxiii. **DRIVER** – Mark to indicate the driver's insurance policy covers any vehicle he/she drives, but the vehicle is not insured.
- xxiv. **VEHICLE** – Mark to indicate the motor vehicle is insured as required.

**7B. VEHICLE**

7B. VEHICLE — OWNER NAME (Last, First, MI) & ADDRESS (Street, City, State, Zip) <input type="checkbox"/> SAD						PHONE NUMBER <input type="checkbox"/> SAD																		
YEAR	MAKE	MODEL			COLOR	VEH. TYPE	TOTAL NO. OF OCC.																	
LICENSE — PLATE NO. <input type="checkbox"/> Temporary Tag		STATE	YEAR	VIN																				
TOWED FROM SCENE <input type="checkbox"/> Yes <input type="checkbox"/> No	TOWED BY <input type="checkbox"/> Unknown <input type="checkbox"/> NA		VEHICLE DAMAGE (Mark all damaged areas)			None / No Damage																		
TOWED DUE TO DIS. DAMAGE <input type="checkbox"/> Yes <input type="checkbox"/> No		INITIAL IMPACT NO: <table border="1"> <tr><td>2</td><td>3</td><td>4</td><td>5</td><td>6</td><td>7</td></tr> <tr><td>1</td><td>15</td><td>16</td><td>17</td><td>8</td><td></td></tr> <tr><td>14</td><td>13</td><td>12</td><td>11</td><td>10</td><td>9</td></tr> </table>			2	3	4	5	6	7	1	15	16	17	8		14	13	12	11	10	9	18 - Undercarriage 22 - Cargo 19 - Windshield 23 - Unknown 20 - Burned 24 - Other (Explain) 21 - Trailer / Towed Unit	
2	3	4	5	6	7																			
1	15	16	17	8																				
14	13	12	11	10	9																			
VEHICLE BODY TYPES — Automobiles / Specialty Vehicles <input type="checkbox"/> Vehicle Used As Public Conveyance <input type="checkbox"/> Vehicle Used for Electronic Ride-Hailing (Transportation Network Company)																								
<input type="checkbox"/> Passenger Car <input type="checkbox"/> Passenger Van (<9 Seats) <input type="checkbox"/> 9-12 Passenger Van <input type="checkbox"/> 15- Passenger Van <input type="checkbox"/> Sport Utility Vehicle <input type="checkbox"/> Limousine (7-8 W / Driver) <input type="checkbox"/> Limousine (9-15 W / Driver) <input type="checkbox"/> Motorized Bicycle / Moped		<input type="checkbox"/> Small Bus (9-15 W/Driver) <input type="checkbox"/> Large Bus (16+ W/Driver) <input type="checkbox"/> School Bus <input type="checkbox"/> Intercity <input type="checkbox"/> Transit / Commuter <input type="checkbox"/> Charter / Tour <input type="checkbox"/> Other		<input type="checkbox"/> Motorcycle <input type="checkbox"/> ATV <input type="checkbox"/> 2 Wh <input type="checkbox"/> 3 Wh <input type="checkbox"/> 4 Wh <input type="checkbox"/> 5 Wh / More <input type="checkbox"/> Unknown		<input type="checkbox"/> Autocycle <input type="checkbox"/> Recreational Off-Highway Vehicles (ROV) <input type="checkbox"/> Motor Home <input type="checkbox"/> Farm Implements <input type="checkbox"/> Construction Equip. Heavy Mach. <input type="checkbox"/> Other Vehicle (Code) _____ <input type="checkbox"/> Unknown (Explain)		<input type="checkbox"/> Cargo Van <input type="checkbox"/> Pickup <input type="checkbox"/> Other Heavy Truck <input type="checkbox"/> Single-unit Truck; 2 axles, 6 tires <input type="checkbox"/> Single-unit Truck; 3 or more axles <input type="checkbox"/> Truck Tractor <input type="checkbox"/> GVW / GCW RATING (Not Licensed Weight) (Pickups, Cargo Vans, All Trucks, Truck Tractors, or Haz Mat Placard Veh. Only) <input type="checkbox"/> Less than or equal to 10,000 lbs. <input type="checkbox"/> 10,001 - 26,000 lbs. <input type="checkbox"/> Greater than 26,000 lbs. <input type="checkbox"/> Unknown																
FIRST TRAILER / TOWED UNIT		YEAR	MAKE	MODEL			Record Subsequent Trailer / Towed Units in Section 9 — Narrative.																	
LICENSE — PLATE NO.		STATE	YEAR	VIN																				
SECOND TRAILER / TOWED UNIT		YEAR	MAKE	MODEL																				
LICENSE — PLATE NO.		STATE	YEAR	VIN																				
AUTOMATION SYSTEM OR SYSTEMS IN VEHICLE <input type="checkbox"/> Yes <input type="checkbox"/> No <input type="checkbox"/> Unknown		If marked Yes, complete Automation System Levels Engaged at Time of Crash and Driver Ceded Control fields →		AUTOMATION SYSTEM LEVELS ENGAGED AT TIME OF CRASH <input type="checkbox"/> No Automation <input type="checkbox"/> Partial Automation <input type="checkbox"/> High Automation <input type="checkbox"/> Automation System(s) Engaged Level Unknown			DRIVER CEDED CONTROL <input type="checkbox"/> Yes <input type="checkbox"/> No <input type="checkbox"/> Unknown <input type="checkbox"/> NA																	
EMERGENCY VEHICLE INVOLVEMENT <input type="checkbox"/> NA		<input type="checkbox"/> Police <input type="checkbox"/> Ambulance <input type="checkbox"/> Fire <input type="checkbox"/> Other (Must check "A" or "B") →			<input type="checkbox"/> A. Emergency Vehicle on Emergency Run <input type="checkbox"/> B. Stationary With Emergency Equip. Activated			CONTRIBUTING TRAFFIC CONDITIONS <input type="checkbox"/> NA <input type="checkbox"/> Congestion Ahead <input type="checkbox"/> Crash Ahead <input type="checkbox"/> Other Incident Ahead <input type="checkbox"/> Unknown (Explain)																

- i. **OWNER NAME (LAST, FIRST, MI) & ADDRESS (STREET, CITY, STATE, ZIP) –** Enter the **motor vehicle** owner's name and most current address. The name on the vehicle registration may differ from the owner's current legal name. Enter owner's current legal name using last name, first name, and middle initial format. **Note:** Do not enter a period after an initial.

Enter "Unknown" if the owner cannot be determined.

**SAD – (Same as Driver) –** Mark if the **driver** is the owner of the motor vehicle. No further information is needed in this field if this box is marked.

- ii. **PHONE NUMBER –** Enter the **motor vehicle** owner's telephone number, including the area code.

**SAD – (Same as Driver) –** Mark if the **driver** is the owner of the motor vehicle. No further information is needed in this field if this box is marked.

- iii. **YEAR –** Enter four-digit motor vehicle model year. If in doubt, use year indicated on title or as obtained from the Department of Revenue.

- iv. **MAKE –** Enter the **motor vehicle** make. Use the appropriate NCIC code or the complete name.

- v. **MODEL –** Enter the manufacturer's motor vehicle model designation. Use the appropriate NCIC code or the complete name.

- vi. **COLOR –** Enter the **motor vehicle** color(s) starting at the top. Use NCIC codes below. Example: "BLK" | "RED" indicates the vehicle is predominately black on top and red on the bottom.

**VEHICLE COLOR ABBREVIATIONS**

AME	Amethyst	DBL	Dk. Blue	MUL	Multicolored	TPE	Taupe
BGE	Beige	DGR	Dk. Green	MVE	Mauve	TRQ	Turquoise

BLK	Black	GLD	Gold	ONG	Orange	WHI	White
BLU	Blue	GRN	Green	PLE	Purple	YEL	Yellow
BRO	Brown	GRY	Gray	PNK	Pink	UNK	Unknown
BRZ	Bronze	LAV	Lavender	RED	Red		Color
CAM	Camouflage	LBL	Lt. Blue	SIL	Silver /		
COM	Chrome	LGR	Lt. Green		Aluminum		
CPR	Copper	MAR	Maroon /	TAN	Tan		
CRM	Cream		Burgundy	TEA	Teal		

- vii. **VEH. TYPE** – (Vehicle Type Code) Enter the code that represents the type of **motor vehicle** at the time it became involved in the crash. This describes how the motor vehicle was being used at the time of the crash and excludes aircraft, watercraft, **personal conveyances** (motorized or human powered but not propelled by pedaling), weapons, and devices operated within the confines of a building. Use the codes listed below.

VEHICLE TYPE CODES	
1. Motor Vehicle In Transport	3. Working Motor Vehicle
2. Parked Motor Vehicle	U. Unknown

1. **Motor Vehicle in Transport** – A **motor vehicle** being used for moving persons or property from one place to another, and is either in motion, in readiness for motion, or on a roadway, but not parked in a designated area. Includes a motor vehicle moving, stopped, disabled, or abandoned on a roadway other than areas designated for parking. See examples for **Motor Vehicle in Transport** in Glossary, *page 20*.
  2. **Parked Motor Vehicle** – A motor vehicle not **in-transport**, other than a **working motor vehicle**, that is not in motion and not located on the **roadway**. A "parked motor vehicle" should be considered to be in-transport during periods when parking is prohibited in roadway lanes used for travel during some periods and for parking during other periods. (See *page 33*, **Parked MV**, for inclusions and exclusions).
  3. **Working Motor Vehicle** – A **motor vehicle** in the act of performing construction, maintenance, or utility work related to the **trafficway**. This "work" may be located within open or closed portions of the trafficway and motor vehicles performing these activities can be within or outside of the trafficway boundaries. For instance, a utility truck parked off the trafficway in a field placing a concrete culvert on the trafficway. (See *page 34*, **Working MV**, for inclusions and exclusions).
  4. **U – Unknown** – The vehicle type is unknown.
- viii. **TOTAL NO. OF OCC.** – (Total Number of Occupants) – Enter the total number of motor vehicle **occupants**, including the **driver** and persons in or on the vehicle at the time of the first **unstabilized event**.
- ix. **LICENSE – PLATE NO.** – Enter the license plate or temporary license / permit number. If a **motor vehicle** has no plates or "homemade" plates, i.e., substitutes for lost or stolen plates, enter "NONE." When a towed unit is involved, enter the license plate number of the power unit (vehicle pulling the trailer / towed unit).

Enter:

**"NOTREQ"** when a crash involves a motor vehicle not requiring a license and not displaying a license plate or temporary license / permit (i.e., government owned vehicles, self-propelled construction equipment, well-driller, etc.).

**"Unk"** if the plate or temporary license / permit number is unknown.

- x. **TEMPORARY TAG** – Mark when the **motor vehicle** has a valid temporary or in-transit license / permit.
- xi. **STATE** – Enter state / province issuing the motor vehicle license or temporary license / permit using the standard NCIC two letter abbreviation as shown in [Appendix C - United States, Canada, and Mexico Abbreviations](#), page 155. Enter "XX" for licenses / permits issued by entities not listed in the appendix. Enter "NA," if NONE or NOTREQ is entered as the license plate number. Enter "UK" if the state / province is unknown.
- xii. **YEAR** – Enter the four-digit year designation of plate / permit. Enter the current year for license plates not displaying a year, such as an apportioned plate. Enter "NA," if NONE or NOTREQ is entered as the license plate number. Enter "Unk" if the year is unknown.
- xiii. **VIN** – Enter the vehicle identification number (VIN) as shown on the **motor vehicle**.
- xiv. **TOWED FROM SCENE** – Mark the appropriate box to indicate whether the motor vehicle was towed from the scene. Vehicles driven from the scene under their own power cannot be listed as towed.
  - 1. **Yes** – Motor vehicle was towed FROM THE SCENE for any reason. This includes times when the driver is arrested or injured and the vehicle is towed. This includes vehicles that are not towed at the time of the investigation, but the reporting officer knows it will be towed at a later time.  
  
 Note: Mark "yes" if a trailer being pulled by a vehicle is towed from the scene, even if the power unit is not towed.
  - 2. **No** – **Motor vehicle** was not towed from the scene. Mark "No" if a tow truck or other vehicle was required to pull a motor vehicle back onto the roadway; however, the involved motor vehicle then left the scene under its own power.
- xv. **TOWED DUE TO DIS. DAMAGE** (Towed Due to **Disabling Damage**) – Mark the appropriate box to indicate if the **motor vehicle** was towed due to disabling damage.
  - 1. **Yes** – Motor vehicle was towed (or will be towed) from the scene resulting from **disabling damage** received in the crash. "Yes" under "Towed from Scene" must be marked.  
  
 Note: Mark "yes" if a trailer being pulled by a motor vehicle is towed due to disabling damage to the trailer, even if the power unit is not towed or is towed, but not due to disabling damage.
  - 2. **No** – One or more of the following apply:
    - a. The **motor vehicle** was not towed. "No" under "Towed from Scene" must be marked.
    - b. The motor vehicle was towed from the scene; however, the damage it sustained in the crash was not disabling. For example, the driver was transported to a medical facility or arrested and the vehicle was towed for safekeeping.
- xvi. **TOWED BY** – Enter the name, address, and telephone number (including area code) of the tow company or individual that towed the motor vehicle from the scene.  
  
**Unknown** – Mark if the motor vehicle was towed and the company or individual towing it cannot be determined.

**NA** – Mark if the **motor vehicle** was not towed. This must be marked if "No" is marked in *Section 7 - Towed From Scene*.

xvii. **VEHICLE DAMAGE** – Indicate **damage** sustained by the motor vehicle, if any, during the crash.

VEHICLE DAMAGE (Mark all damaged areas)								<input type="checkbox"/> None / No Damage	
INITIAL IMPACT NO:	2	3	4	5	6	7	18 - Undercarriage	22 - Cargo	
<input type="checkbox"/> NA	1	15	16	17	8	9	19 - Windshield	23 - Unknown	
	14	13	12	11	10		20 - Burned	24 - Other	(Explain)
							21 - Trailer / Towed Unit		

- None / No Damage** – Mark if the **motor vehicle**, including any towed unit and / or **cargo**, was not damaged.
- Initial Impact No.** – Enter the number corresponding to the initial impact point on the motor vehicle, e.g., if the initial impact point was on the towed unit, enter "21"; if initial impact was to the cargo, enter "22". Enter the initial impact number if contact was made, even if there was no apparent **damage**.

**Note:** "20 - Burned" cannot be entered as an initial impact number.

**NA** – Mark if there is no impact, e.g. a **motor vehicle** overturns, an **occupant** falls from a vehicle, or a vehicle immersed in water and there is no initial impact.

- Vehicle Damage** – Circle number(s) corresponding to the damaged areas of the motor vehicle.

Circle "20 – Burned" when a motor vehicle is damaged by fire, even if there is no impact or damage other than that caused by burning.

Circle "22 – Cargo" when **cargo** becomes disengaged from the **motor vehicle** and is damaged. Disengaged cargo becomes an "**other object**" once it comes to rest.

Circle "24 – Other" for damage due to the motor vehicle being immersed, e.g., interior damage. Damage from impact following immersion should be marked with the number corresponding to the damage sustained.

xviii. **VEHICLE BODY TYPES** – This field identifies body types of all **motor vehicles** involved. Body type identification is based on vehicle design, NOT how it is licensed or used.

VEHICLE BODY TYPES—Automobiles/Specialty Vehicles		<input type="checkbox"/> Vehicle Used As Public Conveyance	<input type="checkbox"/> Vehicle Used for Electronic Ride-Hailing (Transportation Network Company)		
<input type="checkbox"/> Passenger Car <input type="checkbox"/> Passenger Van (<9 Seats) <input type="checkbox"/> 9–12 Passenger Van <input type="checkbox"/> 15- Passenger Van <input type="checkbox"/> Sport Utility Vehicle <input type="checkbox"/> Limousine (7-8 W/ Driver) <input type="checkbox"/> Limousine (9-15 W/ Driver) <input type="checkbox"/> Motorized Bicycle / Moped	<input type="checkbox"/> Small Bus (9-15 W/Driver) <input type="checkbox"/> Large Bus (16+ W/Driver) <input type="checkbox"/> School Bus <input type="checkbox"/> Intercity <input type="checkbox"/> Transit / Commuter <input type="checkbox"/> Charter / Tour <input type="checkbox"/> Other	<input type="checkbox"/> Motorcycle <input type="checkbox"/> ATV <input type="checkbox"/> 2 Wh <input type="checkbox"/> 3 Wh <input type="checkbox"/> 4 Wh <input type="checkbox"/> 5 Wh / More <input type="checkbox"/> Unknown	<input type="checkbox"/> Autocycle <input type="checkbox"/> Recreational/Off-Highway Vehicles (ROV) <input type="checkbox"/> Motor Home <input type="checkbox"/> Farm Implements <input type="checkbox"/> Construction Equip. Heavy Mach. <input type="checkbox"/> Other Vehicle (Code) _____ <input type="checkbox"/> Unknown (Explain)	<input type="checkbox"/> Cargo Van _____ <input type="checkbox"/> Pickup _____ <input type="checkbox"/> Other Heavy Truck _____ <input type="checkbox"/> Single-unit Truck; 2 axles, 6 tires <input type="checkbox"/> Single-unit Truck; 3 or more axles <input type="checkbox"/> Truck Tractor _____ <input type="checkbox"/> Number of Trailer / Towed Units: (Applies to all Vehicle Body Types MUST COMPLETE) <input type="text"/>	<b>GVW / GCWV RATING</b> (Not Licensed Weight) (Pickups, Cargo Vans, All Trucks, Truck Tractors, or Haz Mat Placard Veh. Only) <input type="checkbox"/> Less than or equal to 10,000 lbs. <input type="checkbox"/> 10,001 - 26,000 lbs. <input type="checkbox"/> Greater than 26,000 lbs. <input type="checkbox"/> Unknown

**Vehicle Used as Public Conveyance** – Mark if the motor vehicle is a public conveyance.

A public conveyance is a **motor vehicle**, either publicly or privately owned, engaged in the business of passenger transportation services. This includes, but is not limited to, buses, taxis, **limousines**, and shuttle services with or without passengers at the time of the crash. Private carpooling is not included under this definition.

**Vehicle Used for Electric Ride-Hailing (Transportation Network Company)** – Mark if the motor vehicle is being used for electric ride-hailing at the time of the crash.

An electric ride-hailing transportation network company (sometimes known as Mobility Service Providers or MSPs) connects, via websites and mobile apps, paying passengers with drivers who provide such passengers with transportation on the driver's non-commercial vehicle. Example, Uber or Lyft.

**Note:** Mark Vehicle Used as Public Conveyance and Vehicle Used for Electric Ride-Hailing (Transportation Network Company) if a motor vehicle meets both criteria at the time it is involved in the crash.

1. **Passenger Car** – A **motor vehicle** other than the vehicles listed below typically designed for carrying eight or fewer persons. Includes sedans, hardtops, hatchbacks, convertibles, and station wagons.
2. **Passenger Van (< 9 Seats)** – Includes passenger vans with a seating capacity of less than 9 only and does not include cargo vans. Also includes mini vans. A passenger van is a **motor vehicle** which is basically a "box on wheels" identifiable by its enclosed passenger area, step-up floor, and relatively short (or non-existent) hood.
3. **9-12 Passenger Van** – Includes passenger vans with a seating capacity of 9 to 12 including the driver. A passenger van is a **motor vehicle** which is basically a "box on wheels" identifiable by its enclosed passenger area, step-up floor, and relatively short (or non-existent) hood.
4. **15-Passenger Van** – Includes passenger vans with a seating capacity up to 15 including the driver. A passenger van is a **motor vehicle** which is basically a "box on wheels" identifiable by its enclosed passenger area, step-up floor, and relatively short (or non-existent) hood.
5. **Sport Utility Vehicle** – A **motor vehicle** designed for carrying ten or fewer persons, and generally considered a multi-purpose vehicle that is designed to have off-road capabilities. These vehicles are generally, but not always, four-wheel-drive and have increased ground clearance.

Includes vehicles like Blazer, Jimmy, Durango, 4Runner, Cherokee, Comanche, Explorer, Excursion, Suburban, Highlander, Sequoia, Rav4, Hummer, Armada, Xterra, Tahoe, etc.

**Note:** Four-wheel-drive passenger cars are not considered sport utility vehicles. They are considered passenger cars, unless they fit any of the other descriptions listed.

6. **Limousine (7-8 W/Driver)** – Any **motor vehicle** OPERATING IN **INTRASTATE COMMERCE** having a seating capacity of 7 to 8 **occupants**. A private limousine not used in intrastate commerce should be shown as a "passenger car."
7. **Limousine (9-15 W/Driver)** – Any **motor vehicle** operating **in commerce** having a seating capacity of 9 to 15 **occupants**. Normally a stretched vehicle. A private limousine not used in intrastate commerce should be shown as a "passenger car."
8. **Motorized Bicycle / Moped** – Any two or three-wheeled device having an automatic transmission and a motor with a cylinder capacity of not more than fifty cubic centimeters, capable of producing less than three gross brake horsepower, and propelling the device no faster than thirty miles-per-hour on level ground.

Includes a MOPED, which is a speed-limited motor-driven cycle which may be propelled by pedaling. Excludes **pedalcycles** with a motor.

9. **Small Bus / Large Bus** – A bus is a **motor vehicle** with seating capacity of nine or more persons, including the driver.

a. **Small Bus (9–15 W/Driver)** – A bus with seating capacity of nine to fifteen persons, including the driver.

It does not include a van-based bus (passenger van) or a **limousine**.

b. **Large Bus (16+ W/Driver)** – A bus with seating capacity of sixteen or more persons, including the driver.

Sub-categories of small bus and large bus: One must be selected when small bus or large bus is identified as a body type.

i. **School Bus** – A motor vehicle used for the transportation of any school pupil at or below the 12th grade level to or from a public or private school or school-related activity.

A **motor vehicle** is a **school bus** only if it is externally identifiable by the following characteristics:

1. Its color is yellow.
2. Equipped with red lights capable of flashing on front and rear.
3. The words "school bus" appear on the front and rear.
4. Lettering on both sides identifies the school or school district served, or the company operating the bus.

Includes (but is not limited to):

- Any **motor vehicle** which meets the above criteria.
- Any such motor vehicle going to pick up, or returning from delivering school pupils.

Excludes:

- Trips which involve the transportation exclusively of non-student passengers or exclusively for purposes other than school-related activities. Example: A bus being used to transport non-school pupils such as senior citizens or migrant workers.

ii. **Intercity** – A bus used for long-distance passenger transportation between cities over fixed routes with regular schedules.

Includes a cross-country bus and buses that service between cities some distance apart, not cities that share borders.  
Examples: Greyhound or Trailways bus

iii. **Transit / Commuter** – A bus used for passenger transportation over fixed, scheduled routes within primarily urban geographical areas.

Includes service within a city and between cities that share borders.



Examples: City metro or a trolley (on highway tires).

- iv. **Charter / Tour** – A bus providing contract service for a group tour or outing, usually on a round-trip basis.

This does not include a [limousine](#).

- v. **Other** – Any bus used for transportation purposes other than [school bus](#), transit / commuter bus, intercity bus, or charter / tour bus.

Includes (but is not limited to):

- Private company providing transportation services for its own employees and others (hotel shuttles, etc.).
- Non-governmental organization (such as churches and non-profit groups).
- Non-educational unit of government (such as Department of Corrections).

## 10. **Motorcycle / ATV**

- a. **Motorcycle** – Any [motor vehicle](#) having a seat or saddle for the use of its operator and traditionally designed to travel on not more than three wheels in contact with the ground. Non-traditional designs exist with more than three wheels, and these may be considered a motorcycle. Explain in [Section 9 - Narrative / Statements](#) if a non-traditional motorcycle is involved.
- b. **ATV (All-Terrain Vehicle)** – A [motor vehicle](#) generally with three or four wheels, a saddle-type seat, and handlebars for steering (no steering wheel) and intended for off-road use. Does not include Recreational Off-road Vehicles (ROVs).

Sub-categories of motorcycle and ATV: One must be selected to indicate the wheel configuration when motorcycle or ATV is identified as a body type.

- i. **2 Wh** – Mark when a motorcycle has only two wheels. This cannot be selected for an ATV.
- ii. **3 Wh** – Mark when a motorcycle or ATV has three wheels.
- iii. **4 Wh** – Mark when a motorcycle or ATV has four wheels.
- iv. **5 Wh / More** – Mark when a motorcycle or ATV has five or more wheels.
- v. **Unknown** – Mark when this information is unknown. Explain in [Section 9 - Narrative / Statements](#).

11. **Autocycle** – A large [motorcycle](#) with one rear wheel and two front wheels, with either a saddle and handlebars or seat(s) and a steering wheel, that can be fully enclosed, partially enclosed, or unenclosed.

12. **Recreational Off-Highway Vehicles (ROV)** – ROVs are intended to be used on terrain similar to that on which all-terrain vehicles (ATV) are used. ROVs are

distinguished from ATVs by the presence of a steering wheel instead of a handlebar for steering, bench or bucket seats for the driver and passenger(s) instead of straddle seating, and foot controls for throttle and braking instead of levers located on the handlebar. In addition, ROVs have a rollover protective system (ROPS), restraint systems, and a maximum speed greater than 30 mph.

13. **Motor Home** – A **motor vehicle** which is a recreational unit suitable to live in, drive cross country, and is mounted on a bus / truck chassis. This does not include pick-up truck slide-in camping units or camper shells.
14. **Farm Implements** – Unlicensed **motor vehicle** typically used for agricultural purposes such as a tractor, combine, cotton picker, etc. Excludes trucks.
15. **Construction Equip. Heavy Mach.** – Unlicensed heavy-duty **motor vehicle** specially designed for executing construction tasks (e.g., bulldozer, road grader, skid-steer loader, etc.). Excludes trucks.
16. **Other Vehicle (Code)** – Any vehicle involved in the crash that is not described by any of the other descriptions shown. Enter the code for the device listed below on the line.
  1. **Riding Mower / Garden Tractor** – Device originally constructed as a lawn mower or garden tractor.
  2. **Golf Cart** – Device originally constructed as an electric or gasoline powered golf cart. This includes any modified or hybrid golf cart converted for transportation use only.
  3. **Snowmobile** – A motorized vehicle with runners and a continuous track, used for traveling over snow.
  4. **Forklift** – A motorized lifting device with two long grid rigid steel bars that can be raised and lowered, used especially to move pallets loaded with boxes or other goods.
  5. **(Historical code – No longer used.)**
  6. **Low Speed Vehicle (LSV)** – A **motor vehicle** with four or more wheels whose top speed is greater than 20 miles-per-hour, but not greater than 25 miles per-hour. LSVs are required to be equipped with basic items of safety equipment: tail lamps, reflex reflectors, parking brake, windshields constructed with safety glass, rearview mirrors, seat belts, and vehicle identification numbers.
  7. **Other (Explain)** – Includes all other vehicles that do not fall into the previous categories (e.g., mini truck).



(Mini Truck)

17. **Unknown (Explain)** – Mark if the motor vehicle body type cannot be determined.

18. **Cargo Van** – A van where the area behind the driver or cab is designed for transporting cargo or operated for general commercial use. This is a 2-axle, 4-tire vehicle only.
19. **Pickup** – A **motor vehicle** having two axles and four tires with a rear cargo area (bed) separate from the passenger compartment and with a gross vehicle weight rating (GVWR) 26,000 pounds or less. Examples include Ford F150, 250, or 350; Chevrolet 1500, 2500, 3500, El Camino, Ranchero, Ridgeline, Avalanche, Brat, Ram, etc.
20. **Other Heavy Truck** – A **motor vehicle** having two axles and four tires with a gross vehicle weight rating (GVWR) more than 26,000 pounds.
21. **Single-unit Truck; 2 axles, 6 tires** – A truck consisting of one unit having 2 axles and 6 tires. This includes, but is not limited to, pickup trucks with four tires on the rear axle and ambulances with this configuration.
22. **Single-unit Truck; 3 or more axles** – A truck consisting of one unit having 3 or more axles. Examples include single unit dump trucks, concrete mixers, etc. **This does not include truck-tractors.**  
  
**Note:** A truck is a motor vehicle designed primarily for carrying property.
23. **Truck Tractor** – A motor vehicle consisting of a single motorized transport device primarily designed for pulling semi-trailers.
24. **Number of Trailer / Towed Units: (Applies to all above Vehicle Body Types - MUST COMPLETE)** – Enter the number of trailers or towed units attached to any of the above **motor vehicle** body types at the time it was involved in the crash. Enter “NA” if there were no trailers or towed units attached to the vehicle. Enter “U” (unknown) if the information is unknown. **DO NOT LEAVE BLANK.**
25. **GVW / GCVW Rating** – The gross vehicle weight rating (**GVWR**) in the case of a single unit motor vehicle or the gross combined vehicle weight rating (**GCVWR**) in the case of a motor vehicle combination (power unit plus towed unit(s)). **This is not the licensed weight.** It only applies to pickups, cargo vans, all trucks, truck tractors, or any vehicles displaying a hazardous materials placard.
  - a. **Less than or equal to 10,000 lbs.** – Mark if the GVWR or GCVWR is less than or equal to 10,000 pounds.
  - b. **10,001 - 26,000 lbs.** – Mark if the GVWR or GCVWR is 10,001 to 26,000 pounds.
  - c. **Greater than 26,000 lbs.** – Mark if the GVWR or GCVWR is greater than 26,000 pounds.
  - d. **Unknown** – Mark if the vehicle meets the criteria where the GVWR or GCVWR is required for the report; however, it cannot be determined. Explain in [Section 9 - Narrative / Statements](#).

e. Location of GVWR tags:

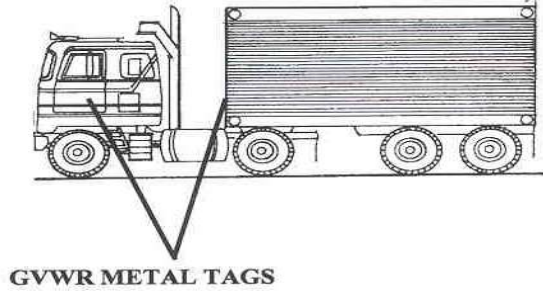

Examples of GVWR tags:



xix. **FIRST TRAILER / TOWED UNIT AND SECOND TRAILER / TOWED UNIT** – These fields identify the first, and if applicable, second trailer or towed unit attached to the [motor vehicle](#) at the time of the crash. Complete fields regardless if a trailer / towed unit(s) received damage or not.

1. **Year** – Enter the four-digit trailer or towed unit year. If in doubt, use the year indicated on the title or as obtained from the Department of Revenue.
2. **Make** – Enter the trailer or towed unit make. Use the appropriate NCIC code or the complete name. Enter NCIC code “HMDE” for homemade trailers.
3. **Model** – Enter the manufacturer’s trailer or towed unit model designation. Use the appropriate NCIC code or the complete name. Enter “NA”- not applicable for homemade trailers.
4. **License-Plate No.**– Enter the trailer / towed unit license plate or temporary license / permit number. If a trailer / towed unit has no plates or temporary license / permit, enter “NONE.”

Enter:

**"NOTREQ"** when a crash involves a trailer / towed unit not requiring a license and not displaying a license plate or temporary license / permit (i.e., government owned vehicles, self-propelled construction equipment, well-driller, etc.).  
**"TEMP"** if trailer / towed unit has a temporary or in-transit license that is not registered. Ex. Out-of-state temporary tag with just a date of expiration.  
**"UNK"** if the plate number or temporary license / permit is unknown.

5. **State** – Enter state / province issuing the trailer / towed unit license or temporary license / permit using the standard NCIC two letter abbreviation as shown in [Appendix C - United States, Canada, and Mexico Abbreviations](#), page 155. Enter "XX" for licenses issued by entities not listed in the appendix. Enter "NA," if NONE or NOTREQ is entered as the license plate number. Enter "UK" if the state is unknown.
6. **Year** – Enter the four-digit year designation of the plate / permit. If in doubt, use the year obtained from the Department of Revenue. Enter the current year for license plates not displaying a year, such as an apportioned plate.

Enter "NA," if NONE or NOTREQ is entered as the license plate number. Enter "UNK" if the year is unknown.

7. **VIN** – Enter the vehicle identification number (VIN) or serial number as shown on the trailer / towed unit. Enter NA if the trailer / towed unit is not assigned a VIN or serial number. Enter "UNK" or "UNKNOWN" if the VIN or serial number is unknown.

**Note:** Enter or record information (year; make; model; license plate number, state, year; and VIN) on the third or subsequent trailer / towed unit in [Section 9 - Narrative / Statements](#).

- xx. **AUTOMATION SYSTEM OR SYSTEMS IN VEHICLE** – This field addresses the automation system(s) equipped in or on the [motor vehicle](#) and engaged at the time of the crash.

AUTOMATION SYSTEM OR SYSTEMS IN VEHICLE <input type="checkbox"/> Yes <input type="checkbox"/> No <input type="checkbox"/> Unknown	If marked Yes, complete Automation System Levels Engaged at Time of Crash and Driver Ceded Control fields →	AUTOMATION SYSTEM LEVELS ENGAGED AT TIME OF CRASH <input type="checkbox"/> No Automation <input type="checkbox"/> Partial Automation <input type="checkbox"/> High Automation <input type="checkbox"/> Automation System(s) Engaged Level Unknown <input type="checkbox"/> Driver Assistance <input type="checkbox"/> Conditional Automation <input type="checkbox"/> Full Automation <input type="checkbox"/> Unknown	DRIVER CEDED CONTROL <input type="checkbox"/> Yes <input type="checkbox"/> No <input type="checkbox"/> Unknown <input type="checkbox"/> NA
--	---	--	--

The hardware and software that are collectively capable of performing part or all of the dynamic driving task on a sustained basis. This term is used generically to describe any system capable of level 1-5 driving automation” (SAE 2016). See SAE International’s Levels of Driving Automation; SAE International Standard J3016 (2014)” on page 84 for automation level determination.

**Dynamic Driving Task** – The operational (steering, braking, accelerating, monitoring the vehicle and roadway) and tactical (responding to events, determining when to change lanes, turn, use signals, etc.) aspects of the driving task, but not the strategic (determining destinations and waypoints) aspect of the driving task.

1. **Yes** – Mark if the [motor vehicle](#) is equipped with an automation system(s) that is capable of performing part or all of the dynamic driving task on a sustained basis. If marked, complete the Automation System Levels Engaged At Time of Crash and Driver Ceded Control fields.
2. **No** – Mark if the motor vehicle is not equipped with an automation system(s) that is capable of performing part or all of the dynamic driving task on a sustained basis. If marked, do not complete the Automation System Levels Engaged At Time of Crash and Driver Ceded Control fields.

3. **Unknown** – Mark if it is unknown if the motor vehicle is not equipped with an automation system(s) that is capable of performing part or all of the dynamic driving task on a sustained basis.

xxi. **AUTOMATION SYSTEM LEVELS ENGAGED AT TIME OF CRASH** – Mark one box that identifies the level of automation system(s) engaged on the **motor vehicle** at the time of the crash. Leave blank if Automation System or Systems In Vehicle is "No." Mark "Unknown" if Automation System or Systems In Vehicle is "Unknown." Note: The number in the parentheses refers to the SAE level of automation 0-5.

1. **No Automation (0)**– Mark if the full-time performance by the human **driver** of all aspects of the dynamic driving task, even when enhanced by warning or intervention system.
2. **Driver Assistance (1)** – Mark if the driver assistance system of either steering or acceleration / deceleration using information about the driving environment and with the expectation that the human driver performs all remaining aspects of the dynamic driving task.
3. **Partial Automation (2)** – The driving mode-specific execution by one or more driver assistance systems of both steering and acceleration / deceleration using information about the driving environment and with the expectation that the human **driver** perform all remaining aspects of the dynamic driving task.
4. **Conditional Automation (3)** – Mark if the driving mode-specific performance by an automated driving system of all aspects of the dynamic driving task with the expectation that the human **driver** will respond appropriately to a request to intervene.
5. **High Automation (4)** – Mark if the driving mode-specific performance by an automated driving system of all aspects of the dynamic driving task, even if a human driver does not respond appropriately to a request to intervene.
6. **Full Automation (5)** – Mark if the full-time performance by an automated driving system of all aspects of the dynamic driving task under all **roadway** and environmental conditions that can be managed by a human **driver**.
7. **Automation System(s) Engaged Level Unknown** – Mark if it is known an automation system(s) was engaged on the **motor vehicle** at the time of the crash; however, the level of automation is unknown.
8. **Unknown** – Mark if it is unknown an automation system(s) was engaged on the motor vehicle at the time of the crash.



## SAE J3016™ LEVELS OF DRIVING AUTOMATION

	SAE LEVEL 0	SAE LEVEL 1	SAE LEVEL 2	SAE LEVEL 3	SAE LEVEL 4	SAE LEVEL 5
What does the human in the driver's seat have to do?	You are driving whenever these driver support features are engaged – even if your feet are off the pedals and you are not steering			You are not driving when these automated driving features are engaged – even if you are seated in "the driver's seat"		
	You must constantly supervise these support features; you must steer, brake or accelerate as needed to maintain safety			When the feature requests, you must drive	These automated driving features will not require you to take over driving	
What do these features do?	These are driver support features			These are automated driving features		
	These features are limited to providing warnings and momentary assistance	These features provide steering OR brake/acceleration support to the driver	These features provide steering AND brake/acceleration support to the driver	These features can drive the vehicle under limited conditions and will not operate unless all required conditions are met	This feature can drive the vehicle under all conditions	
	<ul style="list-style-type: none"> <li>• automatic emergency braking</li> <li>• blind spot warning</li> <li>• lane departure warning</li> </ul>	<ul style="list-style-type: none"> <li>• lane centering OR</li> <li>• adaptive cruise control</li> </ul>	<ul style="list-style-type: none"> <li>• lane centering AND</li> <li>• adaptive cruise control at the same time</li> </ul>	<ul style="list-style-type: none"> <li>• traffic jam chauffeur</li> </ul>	<ul style="list-style-type: none"> <li>• local driverless taxi</li> <li>• pedals/steering wheel may or may not be installed</li> </ul>	<ul style="list-style-type: none"> <li>• same as level 4, but feature can drive everywhere in all conditions</li> </ul>
Example Features						

(SAE International Standard J3016 (Source: SAE International).

xxii. **DRIVER CEDED CONTROL** – This indicates if the driver had ceded control of the motor vehicle and the dynamic driving task of the vehicle was being controlled by the vehicle. This is typically while engaged in "Conditional Automation, SAE Level 3;" "High Automation, SAE Level 4;" or "Full Automation, SAE Level 5," at the time it was involved in the crash. Leave blank if Automation System or Systems In Vehicle is "No." Mark "Unknown" if Automation System or Systems In Vehicle is "Unknown."

- Yes** – Mark if the driver ceded control of the motor vehicle while the dynamic driving task of the vehicle was being controlled by the vehicle at the time it was involved in the crash.
- No** – Mark if the driver had not ceded control of the motor vehicle and the dynamic driving task of the vehicle was being controlled by the driver at the time it was involved in the crash.
- Unknown** – Mark if it is unknown if the driver had ceded control of the motor vehicle and the dynamic driving task of the vehicle was being controlled by the vehicle at the time it was involved in the crash.
- NA** – Mark if there was no driver.

xxiii. **EMERGENCY VEHICLE INVOLVEMENT** – This field indicates operation of any motor vehicle equipped with emergency lights and/or siren that is legally authorized under Section 304.022, RSMo., to respond to emergencies with or without the use of emergency warning equipment.

EMERGENCY VEHICLE INVOLVEMENT				<input type="checkbox"/> NA
<input type="checkbox"/> Police	<input type="checkbox"/> Ambulance	<input type="checkbox"/> A. Emergency Vehicle on Emergency Run		
<input type="checkbox"/> Fire	<input type="checkbox"/> Other (Must check "A" or "B")	<input type="checkbox"/> B. Stationary With Emergency Equip. Activated		

- NA** – Mark when no emergency vehicle was involved.

2. **Police** – Mark if the **motor vehicle** was a police vehicle, equipped with emergency lights and/or siren, regardless of markings. A or B (below) must be marked if emergency equipment was activated.
3. **Fire** – Mark if the motor vehicle was a fire department vehicle equipped with emergency lights and/or siren, regardless of markings. A or B (below) must be marked if emergency equipment was activated.
4. **Ambulance** – Mark if the **motor vehicle** was an ambulance. A or B (below) must be marked if emergency equipment was activated.
5. **Other (Must check "A" or "B")** – Mark if the motor vehicle was not police, fire, or ambulance; however, it was equipped with emergency lights and/or siren and met the statutory requirements for an emergency vehicle given the circumstances. This would include a wrecker making an emergency run to a crash scene, volunteer fire fighter responding to a fire in a personally owned vehicle, or public utility / public service corporation while performing emergency service. A or B (below) must be marked if this is marked.
  - A. **Emergency Vehicle on Emergency Run** – Mark if the emergency vehicle was on an emergency run (moving with emergency equipment activated) at the time of the crash.
  - B. **Stationary With Emergency Equip. Activated** – Mark if the emergency vehicle was stationary with emergency equipment activated when the crash occurred.

xxiv. **CONTRIBUTING TRAFFIC CONDITIONS** – This field describes traffic conditions at the time of the crash.

<b>CONTRIBUTING TRAFFIC CONDITIONS</b>				<input type="checkbox"/> NA
<input type="checkbox"/> Congestion Ahead	<input type="checkbox"/> Crash Ahead	<input type="checkbox"/> Other Incident Ahead	<input type="checkbox"/> Unknown (Explain)	

1. **NA** – Mark if none of the below selections apply. “NA” should be marked if traffic conditions were normal, or traffic congestion did NOT contribute to the crash.
2. **Congestion Ahead** – Mark if heavy volume of traffic caused congestion, which contributed to the crash. The congestion was not caused by a traffic crash or other incident.
3. **Crash Ahead** – Includes instances where congestion is caused by a traffic crash and contributes to this crash.
4. **Other Incident Ahead** – Includes instances where an incident other than a traffic crash has created congestion, which contributed to this crash. An example would include traffic congestion due to a disabled vehicle.
5. **Unknown (Explain)** – Mark if the traffic conditions at the time of the crash cannot be determined. Explain in [Section 9 - Narrative / Statements](#).

## 7C. VEHICLE ACTION / SEQUENCE OF EVENTS CODES

This subsection describes **motor vehicle** action(s) just prior to the first **unstabilized event** to final rest, or the end of the unstabilized event(s). All sequence of events, animal codes, and fixed object codes must be explained in [Section 9 - Narrative / Statements](#). All codes are listed in [Section 8 - Codes, pages 119 - 123](#).



7C. VEHICLE ACTION / SEQUENCE OF EVENTS CODES <input type="checkbox"/> Additional Codes Listed in Narrative (See Codes in Section 8)									
SEQUENCE OF EVENTS CODES <input type="checkbox"/> Unknown					ANIMAL CODE(S)			FIXED OBJECT CODE(S)	
ALCOHOL USE <input type="checkbox"/> Yes <input type="checkbox"/> No <input type="checkbox"/> Unknown <input type="checkbox"/> NA		MARIJUANA USE <input type="checkbox"/> Yes <input type="checkbox"/> No <input type="checkbox"/> Unknown <input type="checkbox"/> NA							

- i. **ADDITIONAL CODES LISTED IN NARRATIVE** – Mark if there are more than fifteen sequence of events codes. Codes in excess of fifteen should be listed in [Section 9 - Narrative / Statements](#).
- ii. **SEQUENCE OF EVENTS CODES** – Starting with the [motor vehicle's](#) actions just prior to the first [unstabilized event](#), identify chronological events associated with the vehicle. Write the code for the first event in the first block, second in the second block, etc. List up to fifteen events with any additional listed in [Section 9 - Narrative / Statements](#). Use the codes listed in [Section 8 - Codes](#). For a description of the codes, refer to [Section 8 - Codes](#) in this manual ([page 119](#)).

Example: A motor vehicle going straight strikes a dog, runs off right side of the road, and strikes a tree. Complete subsection as follows - find code for going straight ("01. Going Straight") and enter "01" in the first space; find code for striking animal ("33. Collision Inv. Animal") and enter "33" in second space; find code for runs off right side of road ("20. Ran Off Road - Right") and enter "20" in the third space; find code for strikes tree ("36. Collision Inv. Fixed Object") and enter "36" in fourth space.

**Unknown** – Mark if the [motor vehicle's](#) sequence of events cannot be determined.

- iii. **ANIMAL CODE(S)** – If sequence of events code "33" (Collision Involving Animal) is marked, a code for the animal involved must be indicated. Enter the appropriate code from the list of animals shown in [Section 8 - Codes](#). For a description of the codes, refer to [Section 8 - Codes](#) in this manual ([page 123](#)). List up to four types of animals involved. Animals include both live and dead animals. Do not list the same type of animal code more than once. In the example above, enter "62" (Dog) in the "Animal Code" space.
- iv. **FIXED OBJECT CODE(S)** – If sequence of events code "36" (Collision Involving Fixed Object) is marked, code(s) for the fixed object(s) must be indicated. Enter the appropriate code identifying the fixed object(s) involved. Identify up to four fixed objects with any additional listed in [Section 9 - Narrative / Statements](#). Enter object codes in chronological order as they were involved. Use the codes listed in [Section 8 - Codes](#). For a description of the codes, refer to [Section 8 - Codes](#) in this manual ([page 123](#)). In example above, enter "20" (Tree / Stump) in the first "Fixed Object Code" space.
- v. **ALCOHOL USE** – This field indicates whether the motor vehicle [driver](#) involved in the crash is suspected to have used alcohol. This is reflective of the investigating officer's opinion of the use (presence) of alcohol, not a judgment of quantity or intoxication. The officer's opinion as to alcohol's contribution to the crash is shown under "[Probable Contributing Circumstances](#)."
  - 1. **Yes** – Mark if use of alcohol on the part of the driver is suspected. This must be selected if "Alcohol" is marked under Probable Contributing Circumstances for the driver / operator.
  - 2. **No** – Mark if use of alcohol on the part of the [driver](#) is not suspected.
  - 3. **Unknown** – Mark if alcohol use on the part of the driver is unknown.
  - 4. **NA** – Mark if there is no driver.
- vi. **MARIJUANA USE** – This field indicates whether the [motor vehicle driver](#) involved in the crash is suspected to have used marijuana. This is reflective of the investigating officer's opinion of the use (presence) of marijuana, not a judgment of quantity or impairment. The officer's opinion as to the driver's use of marijuana contributing to the crash is shown under "[Probable Contributing Circumstances](#), 19 – Drugs."

1. **Yes** – Mark if use of marijuana on the part of the driver is suspected.
2. **No** – Mark if use of marijuana on the part of the **driver** is not suspected.
3. **Unknown** – Mark if marijuana use on the part of the driver is unknown.
4. **NA** – Mark if there is no driver.

**7D. PROBABLE CONTRIBUTING CIRCUMSTANCES**

- i. This subsection is used to record **driver** errors, **vehicle** defects, and miscellaneous circumstances that contributed to the crash. Criterion here should not be whether an arrest was made, but that the circumstances existed in the investigator's judgment. Enter all codes associated with probable contributing circumstances that apply and only if it contributed to the crash and not simply that it existed. If "None" or "Unknown" are marked, then no other circumstances can be entered. Use the codes listed in [Section 8 - Codes](#). For a description of the codes, refer to [Section 8 - Codes](#) in this manual (page 129).

<b>7D. PROBABLE CONTRIBUTING CIRCUMSTANCES</b> <input type="checkbox"/> Additional Codes Listed in Narrative (See Codes in Section 8)	DISTRACTED / INATTENTIVE CODE(S) (See Codes in Section 8) <input type="checkbox"/> NA
<input type="checkbox"/> None <input type="checkbox"/> Unknown (Explain)	

1. **Additional Codes Listed in Narrative** – Mark if there are more than ten probable contributing circumstances codes. Codes in excess of ten should be listed in [Section 9 - Narrative / Statements](#).
2. **None** – Mark only if, in the investigating officer's opinion, there were no probable contributing circumstances. When marked, no other circumstance codes can be entered.
3. **Unknown (Explain)** – Mark if it is unknown whether actions on the part of the **driver** contributed to the crash or if there was not enough evidence at the scene to ascertain who or what contributed. If **marked**, no other selections can be made. Explain in [Section 9 - Narrative / Statements](#). When marked, no other circumstance codes can be entered.

- ii. **DISTRACTED / INATTENTIVE CODE(S)** – This field identifies the type of distraction(s) involved when "Distracted / Inattentive" is selected as a probable contributing circumstance. Up to four can be entered. Use the codes listed in [Section 8 - Codes](#). For a description of the codes, refer to [Section 8 - Codes](#) in this manual (page 115). Explain cause of the distraction or inattention in [Section 9 - Narrative / Statements](#).

**NA** – Mark if "Distracted / Inattentive" was not marked as a probable contributing circumstance.

**7E. WORK ZONE-RELATED** – A crash that occurs in or related to a construction, maintenance, or utility work zone, whether or not workers were actually present at the time of the crash. Work zone-related crashes may also include those involving motor vehicles slowed or stopped because of the work zone, even if the first harmful event occurred before the first warning sign.

<b>7E. WORK ZONE</b>	<b>TYPE OF WORK ZONE</b> <input type="checkbox"/> NA	<b>LOCATION OF THE CRASH</b> <input type="checkbox"/> NA <input type="checkbox"/> Unknown	<b>LAW ENFORCEMENT PRESENT</b>
<input type="checkbox"/> Yes <input type="checkbox"/> No <input type="checkbox"/> Unknown Workers Present <input type="checkbox"/> Yes <input type="checkbox"/> No <input type="checkbox"/> Unknown	<input type="checkbox"/> Lane Closure <input type="checkbox"/> Work on Shoulder or Median <input type="checkbox"/> Lane Shift / Crossover <input type="checkbox"/> Other Type of Work Zone <input type="checkbox"/> Intermittent or Moving Work <input type="checkbox"/> Unknown	<input type="checkbox"/> Before the First Work Zone Warning Sign <input type="checkbox"/> Transition Area <input type="checkbox"/> Advance Warning Area <input type="checkbox"/> Activity Area <input type="checkbox"/> Termination Area	<input type="checkbox"/> Yes <input type="checkbox"/> No <input type="checkbox"/> Unknown <input type="checkbox"/> NA

- i. **WORK ZONE** – Mark to indicate if the crash occurred in a work zone and, if so, whether workers were present.

A work zone is an area of a [trafficway](#) where construction, maintenance, or utility work activities are identified by warning signs / signals / indicators, including those on transport devices (e.g., signs, flashing lights, channelizing devices, barriers, pavement markings, flagmen, warning signs and arrow boards mounted on vehicles in a mobile maintenance activity) that mark the beginning and end of a construction, maintenance, or utility work activity.

A work zone extends from the first warning sign, signal, or flashing lights to the END ROAD WORK sign or the last traffic control device pertinent for that work activity.

Work zones also include roadway sections where there is ongoing, moving (mobile) work activity such as lane line painting or roadside mowing only if the beginning of the ongoing, moving (mobile) work activity is designated by warning signs or signals.

1. **Yes** – Mark if the crash occurred in a work zone. If yes, go to "Workers Present" and mark appropriate box.
  2. **No** – Mark if the crash did not occur in a work zone.
  3. **Unknown** – Mark if it could not be determined if the crash occurred in a work zone.
- ii. **WORKERS PRESENT** – Mark only if the crash occurred in a work zone (marked "Yes" above). Leave blank if the crash was not in a work zone or unknown was marked above.
1. **Yes** – Mark if the crash occurred in a work zone and workers were present at the time of the crash. This includes workers in or on a working motor vehicle, equipment, etc. or off such devices (standing on their feet, sitting, lying, etc.).
  2. **No** – Mark if the crash occurred in a work zone, but no workers were present at the time of the crash.
  3. **Unknown** – Mark if the crash occurred in a work zone and it could not be determined if workers were present at the time of the crash.

Includes (but is not limited to):

- Long-term stationary construction such as building a new bridge, adding travel lanes to the roadway, extending an existing [trafficway](#), etc. (construction activity / work).
- Work involving moving activities such as striping the [roadway](#), [median](#) and [roadside](#) grass mowing / landscaping, pothole repair, lane line painting, etc., where there are warning signs or signals marking the beginning of the moving work area (mobile maintenance activity / work).
- Short-term stationary work such as repairing / maintaining electric, gas, water lines, or traffic signals (utility activity / work) where there are warning signs or signals marking the beginning of the work area.
- Areas identified by signage as a work zone where the ongoing work activity has temporarily paused.

Excludes:

- Any private construction, maintenance, or utility work outside the [trafficway](#).
- Any area of the trafficway where there is moving maintenance activity (e.g., [roadside](#) grass mowing / landscaping, pothole repair, snowplowing, lane line painting) without warning signs or signals.

- Citizen removing snow from the [trafficway](#) as a neighborly gesture.
  - Private individuals picking up trash roadside.
- iii. **TYPE OF WORK ZONE** – Mark the box that best identifies the type of [work zone](#) at the crash scene.
1. **NA** – The crash did not occur within a work zone. This must be marked if Work Zone is marked “No”.
  2. **Lane Closure** –The closure of travel lane in one direction of a [roadway](#).
  3. **Lane Shift / Crossover** – Involves the lateral shift of vehicular traffic from the original travel lane. This could occur within the same roadway or traverse to an opposing roadway.
  4. **Intermittent or Moving Work Zone** – Temporary activity that may move or shift frequently. Example, mobile striping or mowing operation.
  5. **Work on Shoulder or Median** – The closure of the [shoulder](#) or [median](#) within a [trafficway](#).
  6. **Other Type of Work Zone** – Mark if the crash occurred in a work zone not listed in the attributes for this field. *Explain in [Section 9 - Narrative / Statements](#).*
  7. **Unknown** – Mark if it could not be determined the type of work zone present. This should be marked if Work Zone is marked “Unknown.”
- iv. **LOCATION OF THE CRASH** – Mark the box that best identifies the location of the crash in association with the [work zone](#) area (i.e., [work zone-related](#)).
1. **NA** – The crash did not occur within a work zone. This must be marked if Work Zone is marked “No.”
  2. **Unknown** – Mark if it could not be determined the location of the crash within the work zone area. This should be marked if Work Zone is marked “Unknown.”
  3. **Before the First Work Zone Warning Sign** – Located prior to the first warning sign but related to the [work zone](#) such as a rear end crash due to congestion from the work zone.
  4. **Advance Warning Area** – Located after the first warning sign but before the work area. Informs motorists what to expect ahead.
  5. **Transition Area** – Location where traffic is traversed out of its normal path.
  6. **Activity Area** – Location where the actual work occurs whether workers and equipment were present or not.
  7. **Termination Area** – Location after the activity area where traffic resumes normal operations.

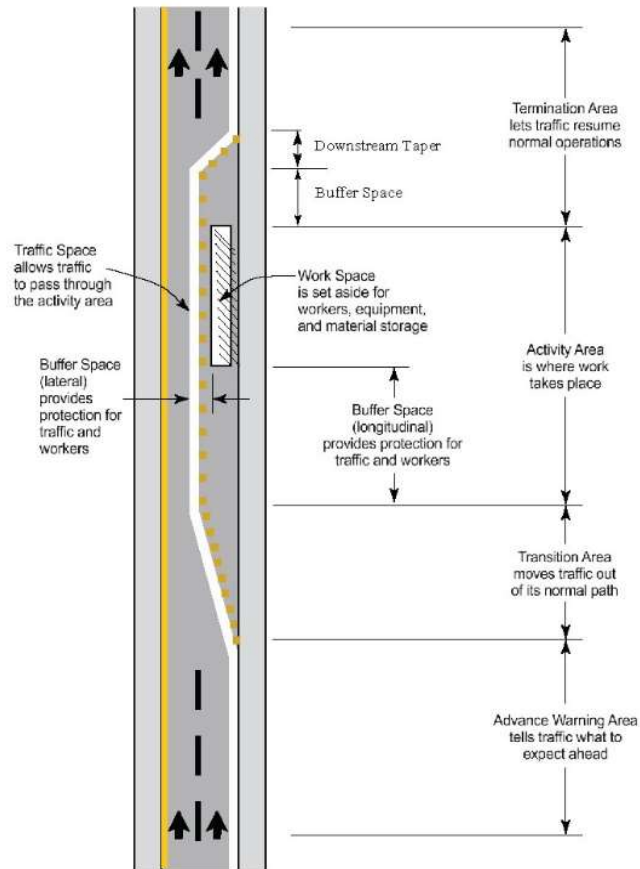

(Source: MMUCC 5th Edition).

v. **LAW ENFORCEMENT PRESENT**

1. **Yes** – Mark if the crash occurred in a **work zone** and law enforcement was present at the time of the crash.
2. **No** – Mark if the crash occurred in a work zone, but no law enforcement was present at the time of the crash.
3. **Unknown** – Mark if the crash occurred in a work zone and it could not be determined if law enforcement was present at the time of the crash.
4. **NA** – The crash did not occur within a **work zone**. This must be marked if Work Zone is marked “No.”

**7F. TRAFFIC CONTROL** - This subsection identifies the type of traffic control device(s) present at the crash scene.

<b>7F. TRAFFIC CONTROL</b> <input type="checkbox"/> None <input type="checkbox"/> Unknown						<b>CONTROL MALFUNCTIONING / INOPERATIVE / MISSING</b>	
Electric:	<input type="checkbox"/> Green / Yellow / Red	<input type="checkbox"/> Flashing Red	<input type="checkbox"/> Flashing Yellow	<input type="checkbox"/> Ramp Meter	<input type="checkbox"/> Other Electric (Explain)		
Other:	<input type="checkbox"/> Stop Sign	<input type="checkbox"/> No Passing Zone	<input type="checkbox"/> Turn Restricted	<input type="checkbox"/> Officer / Flagman	<input type="checkbox"/> Signal On School Bus		
Controls:	<input type="checkbox"/> Warning Sign / Device	<input type="checkbox"/> Railway Crossing Sign / Device	<input type="checkbox"/> School Zone	<input type="checkbox"/> Yield Sign	<input type="checkbox"/> Other (Explain)		
						<input type="checkbox"/> Yes (Explain)	<input type="checkbox"/> No
						<input type="checkbox"/> Unknown	<input type="checkbox"/> NA

- i. **None** – Mark if there were no traffic control devices, electric or other controls, present at the scene at the time of the crash. Mark if a traffic control device is missing, then indicate in *Section 7F - Control Malfunctioning / Inoperative / Missing*.

Mark if a no passing zone (solid yellow line) has been temporarily removed due to [roadway](#) resurfacing and has not been replaced.

- ii. **Unknown** – Mark if the presence of a traffic control device at crash location cannot be determined. Explain in [Section 9 - Narrative / Statements](#).
- iii. **Electric** (Traffic Control Electric Signal)

Electrically powered devices that warn or direct vehicular traffic to take some specific action. This generally applies to the first vehicle approaching the electric signal. Only one can be marked.

1. **Green / Yellow / Red** – Standard traffic signal (with or without turn arrows), either vertical or horizontal. This includes solid and flashing yellow arrows that are part of the signals cycle.
2. **Flashing Red** – Includes either a single flashing red light or when a standard traffic light is set to flashing red.
3. **Flashing Yellow** – Includes either a single flashing yellow light or when a standard traffic light is set to flashing yellow.
4. **Ramp Meter** – A traffic signal that controls the entry of vehicles from a [ramp](#) onto a freeway. Ramp meters control the frequency and spacing of merging vehicles. They normally consist of a two-section signal (red and green only). Also known as a ramp control signal. Mark only if the ramp meter was operating at the time of the crash.



(Source: KC Scout).

5. **Other (Explain)** – Any other traffic control electric signal not listed above. Describe in [Section 9 - Narrative / Statements](#).
- iv. **Other Controls** (Other traffic control)

Mark all that are applicable.

1. **Stop Sign** – A sign that instructs drivers to stop and then proceed only if the way ahead is clear. Normally is red in color and octagonal (eight-sided) with white letters "STOP." This generally applies to the first vehicle approaching the traffic control.
2. **No Passing Zone** – A section of [roadway](#) marked by either a solid yellow line or signs indicating one vehicle should not pass another vehicle going the same direction within that section of roadway.



3. **Turn Restricted** – Ability of vehicles to turn one direction or another is restricted by signs. Examples include no right turn on red, no left turn, or no U-turn. This generally applies to the first vehicle approaching the traffic control.
4. **Officer / Flagman** – Movement of traffic is directed by a law enforcement officer or a flagman. This generally applies to the first vehicle approaching the traffic control.
5. **Signal On School Bus** – A signal and sign on a **school bus** directing traffic in its vicinity. Normally consists of a "Stop" sign and red lights that are operated by a **school bus driver**. This generally applies to the first vehicle approaching the traffic control.
6. **Warning Sign / Device** – Any sign or device erected to control the flow of traffic or to alert motorists of an upcoming **roadway** condition.

Examples include curve ahead sign, dip in road, slippery when wet, deer crossing, arrow boards or chevrons in curves, road closed, bump, etc.

7. **Railway Crossing Sign / Device** – Any sign or device designed to notify drivers of a railway crossing. Includes lights, gate, cross bucks, pavement markings, etc. This generally applies to the first vehicle approaching the traffic control.



8. **School Zone** – Signs, lights, etc. designating a school zone. The zone is normally the area between two or more signs, lights, etc. designating the beginning and possibly end of such zone.
9. **Yield Sign** – A sign that indicates that a vehicle driver should prepare to stop if necessary, but does not need to stop if the right-of-way is clear. Normally triangular in shape with letters "YIELD." This generally applies to the first vehicle approaching the traffic control.
10. **Other (Explain)** - Any other traffic control device, except electric signals, not listed above. Describe in [Section 9 - Narrative / Statements](#).

**v. CONTROL MALFUNCTIONING / INOPERATIVE / MISSING**

- a. **Yes (Explain)** – Mark if one or more of the traffic control devices (electric signals or other) was malfunctioning, inoperative, or missing at the time of the crash. Explain in [Section 9 - Narrative / Statements](#). Mark this even if the malfunctioning, inoperative, or missing control was not a contributor to the crash.

**Note:** A standard traffic signal that is flashing red or yellow is not malfunctioning. A standard traffic signal that is dark (no electrical power) with temporary "Stop" signs in place controlling traffic is not malfunctioning.

- b. **No** – Mark if the traffic control device(s) listed (electric signals or other) were present and operating correctly at the time of the crash.
- c. **Unknown** – Mark if the investigator could not determine if a traffic control device (electric signal or other) was malfunctioning, inoperative, or missing at the time of the crash.
- d. **NA** – Mark if this field is not applicable (there was no device present, or no device was missing).

**Note:** This should be marked if a no passing zone (solid yellow line) has been temporarily removed and has not been replaced.

**7G. OCCUPANT INFORMATION**

**Note:** It is important to ascertain exactly where the person was located in relationship to their transition into or out of a [motor vehicle](#). Once the [unstabilized situation](#) begins, an [occupant](#) remains an occupant until the crash stabilizes.

- If a person is seated with his/her feet outside the vehicle, he/she is considered an occupant.
- If a person is entering or exiting a vehicle, ensure he/she has successfully completed the transition from [pedestrian](#) to occupant or vice-versa.

7G.	OCCUPANTS — NAME (Last, First, MI) ADDRESS (Street, City, State, Zip)	DATE OF BIRTH MM-DD-YYYY	SEX	SEAT LOC	INJ	TRANS- PORT	EJEC- TION	AIR BAG	SAFETY DEVICES	IMPROPER USE?	PHONE NUMBER
										<input type="checkbox"/> Yes <input type="checkbox"/> No <input type="checkbox"/> Unk <input type="checkbox"/> NA	
										<input type="checkbox"/> Yes <input type="checkbox"/> No <input type="checkbox"/> Unk <input type="checkbox"/> NA	
										<input type="checkbox"/> Yes <input type="checkbox"/> No <input type="checkbox"/> Unk <input type="checkbox"/> NA	
										<input type="checkbox"/> Yes <input type="checkbox"/> No <input type="checkbox"/> Unk <input type="checkbox"/> NA	
										<input type="checkbox"/> Yes <input type="checkbox"/> No <input type="checkbox"/> Unk <input type="checkbox"/> NA	



- i. **OCCUPANTS—NAME (LAST, FIRST, MI)** – Enter the [occupant's](#) name on the top line. Enter the occupant's current legal name using last name, first name, and middle initial format. (**Note:** Do not enter a period after the middle initial and leave blank if there is no middle initial).
- ii. **ADDRESS (STREET, CITY, STATE, ZIP)** – Enter the occupant's most current address on the line below the name.  
  
Enter SAD (Same As Driver) if the address is the same as the drivers.
- iii. **DATE OF BIRTH (MM-DD-YYYY)** – Enter the [occupant's](#) date of birth in the month, day, and year format (mm-dd-yyyy). Enter "Unk" if unknown.
- iv. **SEX** – Enter "M" for male, "F" for female, or "U" if the information is unknown.
- v. **SEAT LOC.** – (Seat Location) Enter the appropriate code to indicate the occupant's seat location. Use the codes listed in [Section 8 - Codes](#). For a description of the codes, refer to [Section 8 - Codes](#) in this manual ([page 105](#)).

**Note:** A person sitting in the driver's seat of a "Parked Motor Vehicle" is shown as an occupant, not a driver. The information pertaining to this person is shown in Section 7G – Occupant Information

When one occupant is sitting on another occupant's lap, enter the same seat location code for both and explain in [Section 9 - Narrative / Statements](#).

- vi. **INJ** – ([Injury](#)) Enter one code to indicate the occupant's injury severity. Use the codes listed in [Section 8 - Codes](#). For a description of the codes, refer to [Section 8 - Codes](#) in this manual ([page 106](#)).

**Note:** Injuries should be classified on the basis of conditions at the scene of the crash. The exception to this rule applies to fatal injuries ([late death](#)). Injuries that do not meet these criteria may be documented in [Section 9 - Narrative / Statements](#).

Enter "5" (No Apparent Injury) for occupants who are not injured but transported from the scene to a medical facility for precautionary measures. Explain in [Section 9 - Narrative / Statements](#).

- vii. **TRANSPORT** – Enter one code to indicate whether and how an [occupant](#) was transported from the scene to a medical facility for treatment of crash-related injuries. Use the codes listed in [Section 8 - Codes](#). For a description of the codes, refer to [Section 8 - Codes](#) in this manual ([page 108](#)).

List the name of the transporting agency or person, and medical facility they were transported to in [Section 9 - Narrative / Statements](#) if applicable.

**Note:** Enter "1" (No) for [occupants](#) who are not injured but transported from the scene to a medical facility for precautionary measures. In addition, enter "1" (No) if a person deceased at the scene is transported. In either case, explain in [Section 9 - Narrative / Statements](#).

- viii. **EJECTION** – Enter one code to indicate whether the occupant was ejected from the [motor vehicle](#) or if the field is not applicable. Show ejection codes for all types of vehicles, including motorcyclists. This does not include persons falling off a vehicle. Use the codes listed in [Section 8 - Codes](#). For a description of the codes, refer to [Section 8 - Codes](#) in this manual ([page 108](#)).

**Note: All Fatality Crashes** – Identify ejection path (windshield, door, T-top, etc.) of **everyone ejected in a fatality crash** in [Section 9 - Narrative / Statements](#). This is not applicable for cyclists.

- ix. **AIR BAG** – Enter up to four codes to indicate if air bags were present for the [occupant](#) and whether any airbags were deployed. Use the codes listed in [Section 8 - Codes](#). For a description of the codes, refer to [Section 8 - Codes](#) in this manual ([page 109](#)).
- x. **SAFETY DEVICES** – Enter a maximum of two codes to indicate the type of [safety device\(s\)](#) used, if any, by the occupant. If only one safety device is applicable, then leave the second safety device field blank. Use the codes listed in [Section 8 - Codes](#). For a description of the codes, refer to [Section 8 - Codes](#) in this manual ([page 110](#)).
- xi. **IMPROPER USE?**
  - 1. **Yes** – Mark if the [motor vehicle occupant](#) was using a [safety device](#), but did not use it properly as designed or intended by the manufacturer or safety standards at the time of the crash. Do not mark when the vehicle occupant was not using a safety device.
 

Examples:

    - A manual shoulder and lap belt restraint system was available but only the lap belt was used and the shoulder belt portion was behind the occupant's back.
    - A child is in a booster seat but not using the vehicle's restraint system.
    - A nine-month-old child is in the right rear seating position without a child restraint seat and using a shoulder and lap belt.
    - Automatic shoulder harness and a manual belt were available. The shoulder harness was used but the lap belt was not.
  - 2. **No** – Mark when the motor vehicle [occupant](#) was using a [safety device](#) and there was no indication of misuse at the time of the crash. (The safety device was being used as designed or intended by the manufacturer or safety standards.)
  - 3. **Unk. (Unknown)** – Mark when it is unknown if there was improper use of the safety device by the [motor vehicle](#) occupant. "U" - Use Unknown must be entered for Safety Device.
  - 4. **NA** – Mark if the field is not applicable. Also, mark if no safety device was used by the occupant or present on the motor vehicle. For instance, Code 1. - None or 2. - Not Used was entered in the Safety Devices field for the occupant.
- xii. **PHONE NUMBER** – Enter the [occupant's](#) telephone number, including the area code.

## 7H. COMMERCIAL MOTOR VEHICLE

<b>7H. COMMERCIAL MOTOR VEHICLE</b> <input type="checkbox"/> NA		Required on Vehicle if "Yes" was answered to questions in parts 1 and 2 in CMV involvement criteria and vehicle meets one of the three criteria part 2.							
VEH NO.	MOTOR CARRIER IDENTIFICATION (Leasee, etc.) — NAME & ADDRESS (Street, City, State, Zip) <input type="checkbox"/> SAO					PHONE NUMBER	<input type="checkbox"/> SAO		
COMMERCIAL / NON-COMMERCIAL	<input type="checkbox"/> Interstate Carrier	<input type="checkbox"/> Not In Commerce — Government Vehicle	<input type="checkbox"/> Not In Commerce — Other Vehicle	MC / MX / ICC NO.	USDOT NO.				
	<input type="checkbox"/> Intrastate Carrier	<input type="checkbox"/> Not In Commerce — Rental Vehicle							
CARGO BODY TYPE	<input type="checkbox"/> Enclosed Box	<input type="checkbox"/> Flatbed	<input type="checkbox"/> Concrete Mixer	<input type="checkbox"/> Garbage / Refuse	<input type="checkbox"/> Pole Trailer	<input type="checkbox"/> Vehicle Towing Another Veh.	<input type="checkbox"/> Intermodal Container Chassis	<input type="checkbox"/> NA (No Cargo Body)	<input type="checkbox"/> Other
	<input type="checkbox"/> Cargo Tank	<input type="checkbox"/> Dump	<input type="checkbox"/> Auto Transporter	<input type="checkbox"/> Grain / Chip / Gravel	<input type="checkbox"/> Log			<input type="checkbox"/> Unknown	
HAZARDOUS MATERIALS	PLACARD DISPLAYED <input type="checkbox"/> Yes <input type="checkbox"/> No <input type="checkbox"/> Unknown	4-DIGIT NO.	CLASS	HM CARGO PRESENT <input type="checkbox"/> Yes <input type="checkbox"/> No <input type="checkbox"/> Unknown	HM CARGO RELEASED <input type="checkbox"/> Yes <input type="checkbox"/> No <input type="checkbox"/> Unknown	HAZARDOUS MATERIAL NAME			

Completion of this subsection is required if "Yes" was answered to questions in parts 1 and 2 in the CMV involvement criteria in [Section 1 - General Crash Information](#).

i. **NA**

If "No" was answered to either part 1 or part 2 in the CMV involvement criteria in [Section 1 - General Crash Information](#), mark "NA" and do not complete [Section 7H - Commercial Motor Vehicle](#).

**Note:** If "Yes" was answered to both parts 1 and 2 in the CMV Involvement Criteria fields in [Section 1 - General Crash Information](#), **do not** mark "NA" and complete [Section 7H - Commercial Motor Vehicle](#) for all vehicles that meet the CMV criteria.

- ii. **VEH NO.** – Enter the vehicle number for the commercial motor vehicle that corresponds with the vehicle number in [Section 7 - Drivers, Vehicles, Owners, & Occupants](#). For instance, for a two-vehicle crash if Vehicle 2 meets the CMV Involvement Criteria in [Section 1 - General Crash Information](#), enter "2" in the VEH NO. field.

iii. **MOTOR CARRIER IDENTIFICATION (LEASEE, ETC.)**

A valuable tool to identify the carrier via the Internet is the [SAFER web site](#). (<http://safer.fmcsa.dot.gov/companysnapshot.aspx>). The "Company Snapshot" will allow you to cross-reference the USDOT and MC / MX numbers and carrier's name or identify the appropriate identification number(s) using the carrier's name. Some companies have the same name. Make sure when searching SAFER by carrier name that the correct carrier is selected. Refer to [Appendix D, page 156](#) for instructions on accessing and using the SAFER web site.

1. **Name & Address (Street, City, State, Zip)** – Enter the name of the [motor carrier](#) and the carrier's principal place of business address.

Refer to [Appendix D](#) on [page 156](#) for instructions concerning how to properly identify the motor carrier and how to access carrier information. Make certain the USDOT and/or MC/MX/ICC number match the carrier's name. (Do not include the letters MC, MX, or ICC when entering the number.)

Note reference addresses: A nationwide company may have a local terminal address; however, use the corporate headquarters business address.

**SAO** – (Same as Owner) Mark if the owner's name, [motor carrier](#) name, and address are the same. No further information is needed in this field if this is marked.

2. **Phone Number** – Enter the [motor carrier's](#) telephone number, including area code.

**SAO** – (Same as Owner) Mark if the owner's telephone number and the motor carrier's telephone number are the same. No further information is needed in this field if this is marked.

iv. **COMMERCIAL / NON-COMMERCIAL**

1. **Interstate Carrier** – Any motor carrier where transit between the points of origin and termination does not occur entirely within the borders of the state of origin.

Includes (but is not limited to):

- Transit between a place in a state and a place outside of such state (including a place outside of the U.S.)
- Transit between two places in a state through another state or place outside of the U.S.
- Transit between two places in a state as part of trade, traffic, or transportation originating or terminating outside the state or U.S.

Excludes:

- [Intrastate commerce](#)
2. **Intrastate Carrier** – Any motor carrier where transit between the points of origin and termination occurs entirely within the borders of the state of origin.
  3. **Not In Commerce—Government Vehicle** – Any government vehicle not operating [in commerce](#) whether it is operated by the local, state, or federal government.
  4. **Not In Commerce—Rental Vehicle** – Includes rental vehicles (e.g., U-Haul, Ryder, Penske) that qualify by size (over 10,000 pounds [GVWR/GCVWR](#)) that are operated by a private individual and not [in commerce](#).
  5. **Not In Commerce—Other Vehicle** – Includes personal vehicles that qualify by size (over 10,000 pounds [GVWR/GCVWR](#)) that are operated by a private individual and not [in commerce](#).
- v. **MC / MX / ICC NO.** – Enter the [motor carrier's](#) MC / MX number. The MC / MX number is formerly known as the ICC number. The number is assigned to each carrier by the Federal Motor Carrier Safety Administration for motor carrier identification. Refer to [Appendix D, page 156](#) for instructions concerning how to properly identify the motor carrier and how to access carrier information. Make certain the MC / MX number matches the carrier's name. If there is no MC / MX number identified, enter "none" in this field.
- vi. **USDOT NO.** – Enter the [motor carrier's](#) USDOT number. The USDOT number is the primary number assigned to interstate and intrastate carriers by the Federal Motor Carrier Safety Administration for motor carrier identification. Refer to [Appendix D, page 156](#) for instructions concerning how to properly identify the motor carrier and how to access carrier information. Make certain the USDOT number matches the carrier's name. If there is no USDOT number, enter "none" in this field.
- vii. **CARGO BODY TYPE** – Mark the appropriate box to indicate the [commercial motor vehicle](#) (CMV) cargo body type. Mark only one box.

(Source of illustrations: FMCSA).

1. **Enclosed Box** –



2. **Cargo Tank** –



3. Flatbed –

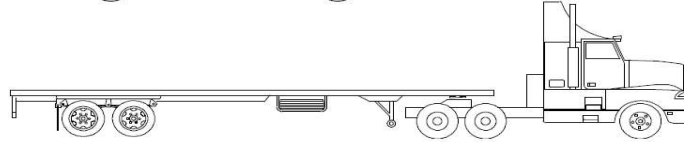
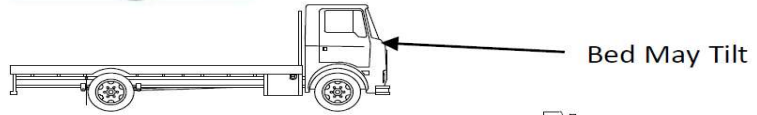

4. Dump –



5. Concrete Mixer –



6. Auto Transporter –



7. Garbage / Refuse –



8. Grain / Chip / Gravel –



9. Pole Trailer –



10. Log –



11. **Vehicle Towing Another Veh.** –



12. **Intermodal Container Chassis** –



13. **NA (No Cargo Body)** –



14. **Other** – Mark if the **commercial motor vehicle** has a cargo body type other than those shown above.

15. **Unknown** – Mark if it cannot be determined what cargo body type the commercial motor vehicle had.

viii. **HAZARDOUS MATERIALS**

1. **Placard Displayed**

- a. **Yes** – Mark if the motor vehicle is displaying a hazardous material placard.
- b. **No** – Mark if the motor vehicle is not displaying a hazardous material placard.
- c. **Unknown** - Mark if it cannot be determined if the motor vehicle was displaying a hazardous material placard at the time of the crash.

2. **4-Digit No.** – Enter the four-digit hazardous materials number found in the middle of the placard, if applicable. (See example below). The number should be located on vehicles transporting hazardous materials in tank cars, cargo tanks, portable tanks, enclosed vans, open vans, or other containers. If more than one placard is displayed, enter the information from only one. The placard information entered must correspond with the information entered into the Hazardous Materials Name field (described below).

Enter "NA" if no placard is displayed.

**Note:** Some placards will not have a 4-Digit number and/or a Class number. In these cases, enter "N/A" in each of the respective fields.

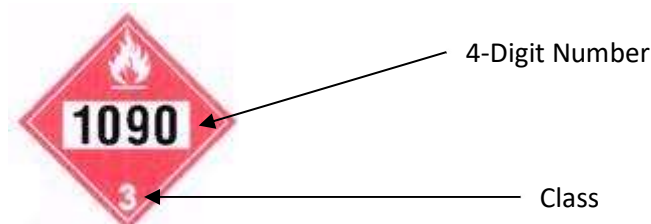

3. **Class** – Enter the number found on the bottom of the diamond placard, if applicable. (See examples above and below). If more than one placard is displayed, enter the information from only one. The placard information entered must correspond with the information entered into the Hazardous Materials Name field (described below).

Enter "NA" if no placard is displayed.

**Note:** Some placards will not have a 4-Digit number and/or a Class number. In these cases, enter "N/A" in each of the respective fields.



4. **HM Cargo Present** (Hazardous Materials Cargo Present)

The shipping papers or manifest identify the type of hazardous materials being transported. See [Appendix D, page 157](#) for guidelines to determine the presence of hazardous materials using shipping papers.

- Yes** – Mark if the motor vehicle is transporting hazardous material(s). An empty hazardous material cargo tank that has not been cleaned and purged is still considered to be transporting hazardous materials.
- No** – Mark if the motor vehicle is not transporting hazardous material(s).
- Unknown** - Mark if it cannot be determined if the motor vehicle was transporting hazardous materials at the time of the crash.

5. **HM Cargo Released** (Hazardous Materials Cargo Released)

- Yes** – Mark if hazardous material cargo was present and it was released due to damage sustained during the crash.

**Note:** Leakage of fuel or oil carried by the vehicle for its own use DOES NOT qualify.

- No** – Mark if hazardous material was not released due to the crash.
- Unknown** – Mark if it cannot be determined if a hazardous material was released due to the crash.

- ix. **HAZARDOUS MATERIAL NAME** – Enter the appropriate hazardous material name as shown on the shipping papers / manifest. Complete this field, even if a hazardous material is being transported and no placard is displayed. See [Appendix D, page 157](#) for guidelines to identify hazardous materials using shipping papers.

**Note:** An empty hazardous material cargo tank that has not been cleaned and purged is still considered to be transporting hazardous materials. Therefore, the name of the material should be entered in this field.

## VIII. SECTION 8 – CODES

- a. **ROADWAY CONDITION** – Enter up to two codes that indicate the [roadway](#) surface condition at the time and location of the crash.

ROADWAY CONDITION CODES	
1. Dry	8. Moving Water
2. Wet	9. Other (Explain)
3. Snow	11. Mud, Dirt, Gravel
4. Ice/Frost	12. Sand
5. Slush	U. Unknown (Explain)
7. Standing Water	

1. **Dry** – Roadway surface that is primarily dry.
2. **Wet** – [Roadway](#) surface that is covered or partially covered with water.
3. **Snow** – Roadway surface that is covered or partially covered with snow.
4. **Ice / Frost** – [Roadway](#) surface that is covered or partially covered with ice or frost.
5. **Slush** – Roadway surface that is covered or partially covered with melting snow or ice.
6. (*Historical code – No longer used.*)
7. **Standing Water** – [Roadway](#) surface that is covered with an excessive amount of water that is not moving.
8. **Moving Water** – Roadway surface that is covered with an excessive amount of water that is moving. Usually attributed to flooding and typically localized.
9. **Other (Explain)** – This would include, but is not limited to, oil, grain, wet leaves, and liquids not listed in road condition attributes. Explain in [Section 9 - Narrative / Statements](#).
10. (*Historical code – No longer used.*)
11. **Mud, Dirt, Gravel** – [Roadway](#) surface covered or partially covered with mud, dirt, or gravel. Indicates the substance's presence on the surface of the roadway at the crash location, not the surface type of the roadway.
12. **Sand** – Roadway surface covered or partially covered with sand. Includes, but is not limited to, sand on the roadway as a result of being blown by the wind, or sand discharged or thrown on the roadway by vehicles. This indicates the substance's presence on the surface of the roadway at the crash location, not the surface type of the roadway.
- U. Unknown (Explain)** – The [roadway](#) condition is unknown. Explain in [Section 9 - Narrative / Statements](#).



- b. **ROADWAY SURFACE** – Indicates the primary surface of the [roadway](#) at the crash location. Only one selection can be made.

ROADWAY SURFACE CODES	
1. Concrete	6. Multi-surface
2. Asphalt	7. Cobblestone
3. Brick	8. Other (Explain)
4. Gravel	U. Unknown
5. Dirt/ Sand	(Explain)

1. **Concrete** – A roadway constructed of concrete for the surface. A concrete roadway with dirt, sand, or gravel washed on it is still a concrete roadway.
2. **Asphalt** – A [roadway](#) constructed of bituminous material for the surface. An asphalt roadway with dirt, sand, or gravel washed on it is still an asphalt road.
3. **Brick** – A roadway constructed using bricks for the surface. A brick roadway with dirt, sand, or gravel washed on it is still a brick roadway.
4. **Gravel** – A [roadway](#) with a gravel surface.
5. **Dirt / Sand** – A roadway with a dirt or sand surface.
6. **Multi-Surface** – Includes roadways with more than one type of surface. Explain in [Section 9 - Narrative / Statements](#).
7. **Cobblestone** – A [roadway](#) constructed of cobblestone for the surface. A cobblestone roadway with dirt, sand, or gravel washed on it is still a cobblestone roadway.
8. **Other (Explain)** – A roadway surface not reflected in the listed attributes of the Roadway Surface Codes. Explain in [Section 9 - Narrative / Statements](#).
- U. **Unknown (Explain)** – The [roadway](#) surface is unknown. Explain in [Section 9 - Narrative / Statements](#). "Unknown" cannot be marked if the crash was investigated at the scene.

- c. **LIGHT CONDITION** – Enter one code that indicates the type / level of light at the time and location of the crash.

LIGHT CONDITION CODES
1. Daylight
2. Dark-Lighted
3. Dark-Unlighted
6. Dark-Unknown Lighting
7. Other (Explain)
8. Dawn/Dusk
U. Unknown (Explain)

1. **Daylight** – The sun is above the horizon at a given location and “natural” light is the main source of lighting and it is not dawn or dusk.
2. **Dark-Lighted** – No "natural" light exists but there is overhead "man-made" lighting on the roadway or area where the crash occurred. Lighted areas will generally include streets within cities or towns and some interchange areas. This does not include lighting from store fronts, houses, parking lots, etc.

3. **Dark-Unlighted** – No "natural" light exists, and no overhead "man-made" lighting is present on the roadway where the crash occurred.
4. *(Historical code – No longer used.)*
5. *(Historical code – No longer used.)*
6. **Dark-Unknown Lighting** – No "natural" light exists, and the investigator is unable to determine if "man-made" lighting was present at the time of the crash.
7. **Other (Explain)** – Includes any light condition other than the light condition attributes listed. Explain in [Section 9 - Narrative / Statements](#). Mark if darkness is caused by an eclipse of the sun or other natural phenomenon.
8. **Dawn / Dusk** – Dawn describes the transition period going from “dark of night” to a daylight condition. This is typically the 30-minute period before the sun rises. Dusk describes the transition period going from a daylight condition to the “dark of night.” This is typically the 30-minute period after the sun sets.
- U. **Unknown (Explain)** – The light condition at the time of the crash is unknown. Explain in [Section 9 - Narrative / Statements](#).

- d. **WEATHER / ENVIRONMENTAL CONDITION** – Enter up to three codes that indicate the prevailing weather, environmental, and atmospheric conditions at the time and location of the crash.

WEATHER / ENVIRONMENTAL CONDITION CODES	
1. Clear	7. Fog / Mist
2. Cloudy	10. Severe Crosswinds
3. Rain	11. Other (Explain)
4. Snow	12. Blowing Snow
5. Sleet / Hail	13. Smoke / Smog
6. Freezing (Temp)	U. Unknown (Explain)

1. **Clear** – Includes partial cloudiness if sunlight is not diminished.
2. **Cloudy** – Usually "overcast" but may include partial cloudiness if light is diminished.
3. **Rain** – Applies when precipitation is falling as rain at the time of the crash.
4. **Snow** – Applies when precipitation is falling as snow at the time of the crash.
5. **Sleet / Hail** – Applies when precipitation is falling as ice (sleet / hail).
6. **Freezing (Temp)** – The outside temperature at the time of the crash was freezing (32 degrees Fahrenheit / 0 degrees Celsius or below).
7. **Fog / Mist** – Fog and mist are primarily water in the form of fine particles suspended or falling in the air. Applies when there is fog and/or mist at the scene at the time of the crash.
8. *(Historical code – No longer used.)*
9. *(Historical code – No longer used.)*
10. **Severe Crosswinds** – Refers to winds traveling at an angle with respect to the travel lanes at velocities significant enough to create a risk that vehicles could be diverted from their path or high-profile vehicles could be blown over. These are winds that are

strong enough to affect vehicle stability. **Note:** Includes only those winds not considered a cataclysmic event.

11. **Other (Explain)** - Includes, but is not limited to, blowing sand, soil, or dirt, or any other weather / environmental condition not listed in the attributes. Explain in [Section 9 - Narrative / Statements](#).
12. **Blowing Snow** - Wind-driven snow that reduces visibility. Blowing snow can be falling snow or snow that has already accumulated but is picked up and blown by strong winds.
13. **Smoke and Smog** – Refers to a natural or man-made condition that causes reduced visibility.
- U. **Unknown (Explain)** – The weather condition at the time of the crash is unknown. Explain in [Section 9 - Narrative / Statements](#).

e. **SEAT LOCATION** – Enter one of the following codes that indicates the seat location for each vehicle occupant.

SEAT LOCATION	
XX – Not Known	
M – Motorcycle	
CP – Commercial Passenger	
OE – Occupant – Enclosed Load Area	SS – Sleeper Section of Cab (truck)
OU – Occupant – Unenclosed Load Area	TU – Trailing Unit
RC – Rail Crew	SV – Other (Explain in Narrative)
VE – Riding on Motor Vehicle Exterior (non-trailing unit)	NA – Not Applicable

**FR, FC, FL** – Shows seat location of driver / other front row occupants in passenger vehicles and trucks and vans. An explanation should be provided in [Section 9 - Narrative / Statements](#) when a driver is not shown seated in the Front-Left (FL) seat.

**Note:** Enter “FL” for the seating position for a person operating a farm tractor, road grader, skid steer, etc. Seating positions for other passengers should be shown as “SV”.

**SR, SC, SL** – Shows seat location of second row occupants in passenger vehicles and trucks.

**TR, TC, TL** – Shows seat location of third row occupants in passenger vehicles and trucks.

**Note:** Show actual seat locations for drivers / occupants of all-terrain vehicles that are not straddled.

**XX** – Shows undetermined seat location.

**M** – Shows seat location of drivers of motorcycles, motorized bicycles, and all-terrain vehicles the driver has to straddle.

**CP** – Shows occupants, other than the driver or rail crew member, on commercial passenger-carrying vehicles, i.e., bus, school bus, train, etc.

**Note:** Use actual seat locations (FL, FR, FC, etc.) for commercial passenger carrying vehicles with three or less standard configuration seating areas, i.e., taxi and van.

**OE** – Shows location of occupants riding in enclosed cargo / bed area of vehicle.

**OU** – Shows location of **occupants** riding in **unenclosed** (open) cargo / bed area of vehicle.

**RC** – Use this code to show the seat location of a member of a train crew (i.e., engineer, conductor). **Train** passengers are shown as "CP".

**Note:** Use actual seat locations (FL, FR, FC, etc.) for rail maintenance vehicles (pickups, heavy duty trucks, etc.) with retractable flange wheels, which can be operated either on rails or a roadway.

**VE – Riding on Motor Vehicle Exterior (non-trailing unit)** – Person outside of **motor vehicle** (on hood, running board, trunk, non-trailing unit, etc.) while riding.

**SS – Sleeper Section of Cab (truck)** – Shows **occupants** in the sleeper section of a truck cab. A sleeper section is generally in the back portion of a truck/truck tractor cab where occupants can sleep.

**TU – Trailing Unit** – Shows **occupants** in or on the trailing / towed unit of the vehicle. Train crew and train passengers should be shown as RC or CP, respectively.

**SV** – Shows seat location of **occupants**:

- In fourth and subsequent rows in non-commercial passenger vehicles, i.e., van, etc.
- Riding on any part of a vehicle not specifically addressed in this section.
- When the motor vehicle is so constructed that it does not fit the normal arrangement for identifying seat positions of occupants other than the driver. This includes a person in a cargo area of an ambulance.
- Passengers (excluding the driver) on **motorcycles, farm equipment, construction equipment, etc.**

**NA** – This is only used when there is no vehicle **driver** or railway engineer and only applies to driver / engineer information. Do not use for **occupant** information.

**Notes:**

- When one **occupant** is sitting on another occupant's lap, enter the same seat location code for both and explain in **Section 9 - Narrative / Statements**.
  - Identify the seat location of every **driver** and **occupant** on each vehicle if known. Do not use "SV" or "CP" for a driver.
  - A person sitting in the driver's seat of a "**Parked Motor Vehicle**" is shown as an occupant, not a driver. The information pertaining to this person is shown in **Section 7G - Occupants**.
- f. **INJURY** – Enter one of the following **numerical** codes to indicate **injury** information for each person involved in the crash if the injury was a direct result of the crash. Injuries not sustained as a direct result of the crash should not be codified in this field; however, they should be noted in **Section 9 - Narrative / Statements**. Note: The letter in parentheses represents the respective KABCO abbreviation.

<b>INJURY</b> (Enter Numerical Value)
1. (K) Fatal Injury
2. (A) Suspected Serious Injury
3. (B) Suspected Minor Injury
4. (C) Possible Injury
5. (O) No Apparent Injury
U. Unknown
N. NA

**Note:** According to ANSI D16.1, a person is any living human. Within the context of this manual and for crash reporting purposes, a fetus is considered to be part of a pregnant woman rather than a separate individual. If a fetus is delivered alive during the [unstabilized event](#), it is considered a person involved in the crash and counted as such.

1. **(K) Fatal Injury** – A fatal injury is any injury that results in death within 30 days after the motor vehicle crash in which the injury occurred. If the person did not die at the scene but died within 30 days of the motor vehicle crash in which the injury occurred, the injury classification should be changed from the attribute previously assigned to the attribute “Fatal Injury.”
2. **(A) Suspected Serious Injury** – A suspected serious injury is any injury other than fatal which results in one or more of the following:
  - Severe laceration resulting in exposure of underlying tissues / muscle / organs or resulting in significant loss of blood
  - Broken or distorted extremity (arm or leg)
  - Crush injuries
  - Suspected skull, chest or abdominal injury other than bruises or minor lacerations
  - Significant burns (second and third degree burns over 10% or more of the body)
  - Unconsciousness when taken from the crash scene
  - Paralysis
3. **(B) Suspected Minor Injury** – A minor injury is any injury that is evident at the scene of the crash, other than fatal or serious injuries. Examples include lump on the head, abrasions, bruises, minor lacerations (cuts on the skin surface with minimal bleeding and no exposure of deeper tissue / muscle).
4. **(C) Possible Injury** – A possible injury is any injury reported or claimed which is not a fatal, suspected serious or suspected minor injury. Examples include momentary loss of consciousness, claim of injury, limping, or complaint of pain or nausea. Possible injuries are those that are reported by the person or are indicated by his/her behavior, but no wounds or injuries are readily evident.
5. **(O) No Apparent Injury** – No apparent injury is a situation where there is no reason to believe that the person received any bodily harm from the motor vehicle crash. There is no physical evidence of injury and the person does not report any change in normal function.
- U. **Unknown** – Injuries could not be determined, e.g., the person left the scene is unavailable for questioning.
- N. **NA** – This is only used when there is no [driver](#) or railway engineer and only applies to [driver / engineer information](#). Do not use for [non-motorists](#) or [occupant](#) information.
- g. **TRANSPORTED (For Medical Treatment)** – Enter one of the following codes for each person involved in the crash indicating whether and how they were transported from the scene to a medical facility for treatment of crash-related [injuries](#). For any person transported to a medical facility, list the name of the transporting agency or person, and the medical facility in [Section 9 - Narrative / Statements](#).

<p><b>TRANSPORTED</b></p> <p>(For Medical Treatment)</p> <p>1. No</p> <p>2. EMS</p> <p>3. Other</p> <p>U. Unknown</p> <p>N. NA</p>
--

**Note:** Enter "1" (No) for a person who is not injured and is transported from the scene to a medical facility for precautionary measures. In addition, enter "1" (No) if a person deceased at the scene is transported. In either case, explain in [Section 9 - Narrative / Statements](#).

1. **No** – The person was not transported from the scene for medical treatment.
2. **EMS** – The person was transported from the scene by ambulance / other emergency medical service vehicle / aircraft.
3. **Other** – The person was transported by any means other than EMS.
- U. **Unknown** – Transportation from the scene for medical treatment is unknown.
- N. **NA** – This is only used when there is no [driver](#) or railway engineer and only applies to driver / engineer information. Do not use for [non-motorist](#) or [occupant](#) transportation information.

h. **EJECTION** – Enter one of the following codes to indicate ejection information for each person in / on the vehicle.

<p><b>EJECTION</b></p> <p>1. NA</p> <p>2. No</p> <p>3. Partially</p> <p>4. Totally</p> <p>U. Unknown</p>
--

**Note: All Fatality Crashes** – Identify ejection path (windshield, door, T-top, etc.) of **everyone ejected in a fatality crash** in [Section 9 - Narrative / Statements](#). This is not applicable for cyclists.

1. **NA** – This is only used when there is no [driver](#) or railway engineer and only applies to driver / engineer information.
2. **No** – Person was not ejected from the vehicle.
3. **Partially** – Person was partially ejected from the vehicle.

4. **Totally** – Person was totally ejected from the vehicle.

U. **Unknown** – It is unknown whether the person was ejected from the vehicle.

- i. **AIR BAG** – Enter up to four of the following codes to indicate the status of the air bag for vehicle **occupants**. Air bag codes refer to the seated position of listed occupants, not the overall deployment of the device within the vehicle. Multiple air bags may be available for an occupant's seated position.

AIR BAG
1. None / Not Applicable
3. Not Deployed
4. Removed
5. Deployed – Front
6. Deployed – Side
7. Deployed – Curtain
8. Deployed – Other (Knee, Air Belt, etc.)
10. Deployment Unknown
U. Air Bag Presence Unknown

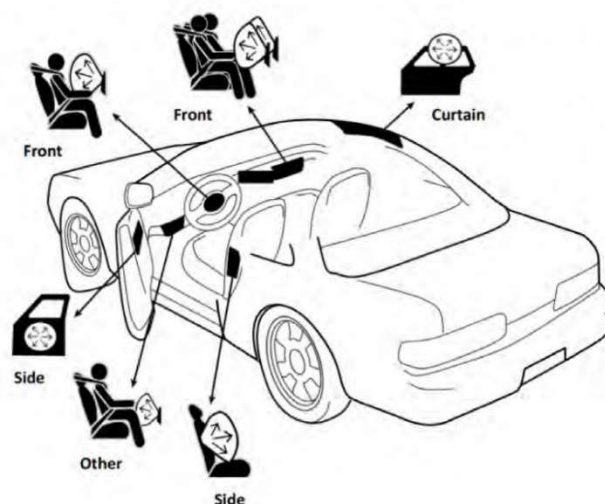

(Source: MMUCC 5th Edition).

1. **None / Not Applicable** – The vehicle is not equipped with any air bags or the entire category is not applicable (**motorized bicycle**, some **motorcycles**, some farm implements, etc.).
2. **(Historical code – No longer used)**
3. **Not Deployed** – The vehicle is equipped with an airbag(s), but they did not deploy.
4. **Removed** – The vehicle was equipped with an airbag(s); however, one or more have been removed. Also includes airbags that have previously deployed and have not been replaced.
5. **Deployed – Front** – The front air bag on the vehicle first-row was deployed during the crash. The driver frontal air bag is generally located in the hub of the steering wheel. The right front passenger frontal air bag is generally located in the dashboard (instrument panel).
6. **Deployed – Side** – The side air bag(s) on the vehicle were deployed during the crash. Generally, refers to an air bag mounted in the outboard side of the seat or in the door.
7. **Deployed – Curtain** – The curtain air bag(s) on the vehicle were deployed during the crash. Generally, refers to a head only, side impact air bag for outboard occupants. These are usually mounted in the roof rail above the side windows, deploying between the glazing and the occupant. These look like a curtain when deployed and are designed to help protect an occupant's head in a side-impact crash. This includes a head impact curtain in a convertible car body type, which deploys upward from the door panel near the lower edge of the side glazing. A single curtain may cover one or all rows, or a vehicle may have one for the first row with another covering multiple rearward rows.

- 8. **Deployed – Other (Knee, Air Belt, etc.)** – Only airbag(s) other than front, side, or curtain were deployed during the crash.
- 9. *(Historical code – No longer used.)*
- 10. **Deployment Unknown** – Deployment of air bags during the crash is unknown.
- U. **Air Bag Presence Unknown** – It cannot be determined if the vehicle was equipped with an air bag(s).

j. **SAFETY DEVICES** – Enter one or two of the following codes to indicate [safety device\(s\)](#) used by each [driver](#), [occupant](#), or [non-motorist](#). If only one safety device is applicable, then leave the second safety device field blank.

SAFETY DEVICES	
1. None	13. Other Helmet
2. Not Used	14. Reflective Clothing
3. Shoulder Belt Only	15. Other (Explain)
4. Lap Belt Only	16. Child Restraint – Type Unknown
5. Shoulder & Lap Belt	17. Stretcher
7. DOT Compliant Motorcycle Helmet	18. Wheelchair
8. No Helmet	19. Lighting
10. Booster Seat	20. Reflectors
11. Child Restraint – Forward Facing	U. Use Unknown
12. Child Restraint – Rear Facing	N. Not Applicable

**Examples:**

SAFETY DEVICES	SAFETY DEVICES	SAFETY DEVICES
5	11	13 14

- 1. **None** – Mark if the vehicle was not equipped with seatbelts for the [driver](#) or [occupant](#) seat location.
- 2. **Not Used** – Mark if the vehicle was equipped with seatbelts; belts were not in use by the [driver](#) or [occupant](#) at the time of the crash.  
  
Mark if a [non-motorist](#) ([pedestrian](#), [pedalcyclist](#), or [other non-motorist](#)) was not wearing reflective clothing or utilizing any other type of safety device.
- 3. **Shoulder Belt Only** – Mark if the vehicle was equipped with seat belts; only the shoulder belt was in use by the [driver](#) or [occupant](#) at the time of the crash.
- 4. **Lap Belt Only** – Mark if the vehicle was equipped with seat belts; only the lap belt was in use by the driver or occupant at the time of the crash.
- 5. **Shoulder and Lap Belt** – Mark if the vehicle was equipped with seat belts; both shoulder and lap belts were in use by the [driver](#) or [occupant](#) at the time of the crash.
- 6. *(Historical code – No longer used.)*
- 7. **DOT Compliant Motorcycle Helmet** – Mark if the [driver](#) or [occupant](#) of a cycle, [ATV](#), or [ROV](#) as well as a [non-motorist](#) was wearing a Department of Transportation (DOT) compliant motorcycle helmet. Helmets that are not DOT compliant should be marked as "13. Other Helmet" (below).

This applies to helmets that are compliant with Federal Motor Vehicle Safety Standards, typically weigh approximately 3 pounds, have an inner liner at least one-inch thick of firm polystyrene foam, have an inside label that states the manufacturer, model, and date of manufacture, and have a DOT sticker on the



back of the helmet. A DOT sticker alone is not sufficient evidence to indicate that the helmet is DOT compliant, as counterfeit stickers have been found affixed to non-compliant helmets.

8. **No Helmet** – Mark if the [driver](#) or [occupant](#) of a cycle, [ATV](#), or [ROV](#) as well as a [non-motorist](#) was not wearing a helmet.
9. **(Historical code – No longer used.)**
10. **Booster Seat** – Mark if the [occupant](#) was properly belted in a booster seat at the time of the crash.
11. **Child Restraint – Forward Facing** – Mark if the [occupant](#) was properly belted in a forward-facing child restraint device at the time of the crash.
12. **Child Restraint – Rear Facing** – Mark if the [occupant](#) was properly belted in a rear facing child restraint device at the time of the crash.
13. **Other Helmet** – Mark if the [driver](#) or [occupant](#) of a cycle, [ATV](#), or [ROV](#) as well as a [non-motorist](#) was wearing a non-DOT compliant helmet.
14. **Reflective Clothing** – Mark if the driver or occupant of a cycle, ATV, or ROV as well as a non-motorist was wearing reflective clothing.
15. **Other (Explain)** – Mark if the [driver](#) or [occupant](#) as well as a [non-motorist](#) was using a [safety device](#) not included in the list of attributes. Describe in [Section 9 - Narrative / Statements](#).
16. **Child Restraint – Type Unknown** – Used when a child passenger is seated in a child safety seat; however, the type used (e.g., forward, rear, or booster, etc.) is not known.
17. **Stretcher** – Mark if the vehicle [occupant](#) was secured on a stretcher by means of a stretcher restraining system and the stretcher itself is also secured by means of a stretcher retention system.  
  
**Stretcher Restraining System** – Original equipment provided by the stretcher manufacture that secures the patient / restraining member and the attaching hardware.  
  
**Stretcher Retention System** – A system that provides means for securing a stretcher to the floor and/or side wall of a vehicle.
18. **Wheelchair** – Mark if the vehicle [occupant](#) was secured in a wheelchair by means of a wheelchair restraint system and the wheelchair itself is also secured by means of a wheelchair retention system.  
  
**Wheelchair Restraint System** – An occupant restraint for which the anchor points for the pelvic-restraint, or both pelvic- and shoulder-restraints, are located on the wheelchair, or on tiedown components not fastened to the vehicle.  
  
**Wheelchair Retention System** – An assembly of hardware and fittings by which loads are transferred directly from the wheelchair tiedown to the vehicle.
19. **Lighting** – A [non-motorist's](#) use of lights on his/her person, or on a [pedalcycle](#), [personal conveyance](#), or [other transport device](#) as safety equipment.
20. **Reflectors** – Mark if the non-motorist used reflectors. A device that reflects light back toward the source of light.

U. **Use Unknown** – Mark if use of **safety devices** could not be determined.

N. **Not Applicable** – Mark if there was no **driver**. This is only used when there is no driver or railway engineer and only applies to driver / engineer information. Do not use for **non-motorist** or **occupant safety device** information.

k. **PERSONAL CONVEYANCE TYPE CODES**

PERSONAL CONVEYANCE TYPE CODES	
1. Scooter— Mobility Assistance / Motorized	5. Stroller
2. Scooter— Stand-up / Motorized	6. Rideable Toy
3. Stand-up / Non-motorized	7. Other (Explain)
4. Stand-up / Motorized-Other	

1. **Scooter – Mobility Assistance / Motorized** – The **pedestrian** was on a motorized powered mobility assistance scooter at the time of the crash. Excludes two-wheeled motorized powered seated scooters used for recreational or transportation purposes.

Includes:



Excludes:



2. **Scooter – Stand-Up / Motorized** – The **pedestrian** was on a stand-up motorized powered scooter (e.g., Razor, Bird, etc.) at the time of the crash. Excludes devices where the pedestrian can sit on the device itself.

Includes:

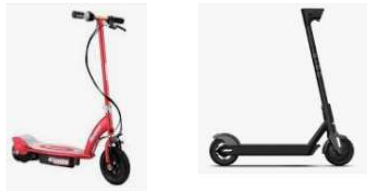

Excludes:



3. **Stand-up / Non-motorized** – The [pedestrian](#) was on a stand-up, non-motorized device (e.g., skateboard, roller skates, roller blades, kick scooter, etc.) at the time of the crash.



4. **Stand-Up / Motorized-Other** – The [pedestrian](#) was on a stand-up, motorized device other than scooter (e.g., hoverboard, Segway transporter, motorized skateboards, etc.) at the time of the crash.

Includes:

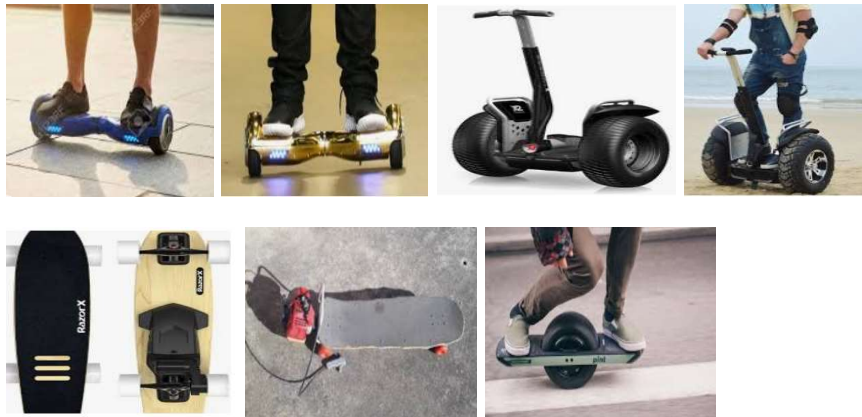

5. **Stroller** – The [pedestrian](#) was in or on a stroller at the time of the crash. Includes baby carriage.



6. **Rideable Toy** – The [pedestrian](#) was on a rideable toy either electrically or human powered at the time of the crash.



7. **Other (Explain)** – Mark if the [pedestrian](#) was on a conveyance not listed above. Includes wheelchair motorized and non-motorized. Explain in [Section 9 - Narrative / Statements](#).



- I. **BICYCLE LANE / FACILITY CODES** – Enter one of the following codes that identifies the type of bicycle lane or bicycle facility the [non-motorist](#) was in or on when struck (if applicable). Information is also provided if the non-motorist would be on or off the [roadway](#) in relation to each lane or facility.

**BICYCLE LANE / FACILITY CODES**

- |                                       |                                |
|---------------------------------------|--------------------------------|
| 1. Signed Route (No Pavement Marking) | 6. Off-street Trails/Sidepaths |
| 2. Shared Lane Markings               | 7. Other (Explain)             |
| 3. On-street Bike Lanes               | U. Unknown                     |
| 4. On-street Buffered Bike Lanes      | N. Not Applicable              |
| 5. Separated Bike Lanes               |                                |

1. **Signed Route (No Pavement Marking)** – (On roadway.) See illustration below.
2. **Shared Lane Markings** – (On roadway.) See illustration below.
3. **On-street Bike Lanes** – (Off roadway if the lane is immediately adjacent to the curb/edge of the roadway. On roadway if the bike lane is between lanes of travel or a lane and the parking lane.) See illustration below.
4. **On-street Buffered Bike Lanes** – (Off roadway if the lane is immediately adjacent to the curb/edge of the roadway. On roadway if the bike lane is between lanes of travel or a lane and the parking lane.) See illustration below.
5. **Separated Bike Lanes** – (Off roadway.) See illustration below.
6. **Off-street Trails / Sidepaths** – (Off roadway.) See illustration below.
7. **Other (Explain)** – The [non-motorist](#) was in or on a bicycle lane / facility that is not reflected in the listed attributes when they were struck. Explain in [Section 9 - Narrative / Statements](#).

- U. **Unknown** – It is unknown if the non-motorist was in or on a bicycle lane / facility when they were struck.
- N. **Not Applicable** – The **non-motorist** was not in or on a bicycle lane / facility when they were struck.



(Source: MMUCC 5th Edition).

m. **DISTRACTED / INATTENTIVE CODES**

DISTRACTED / INATTENTIVE CODES			
1. External Distraction	5. Communication Device—Hand-held	9. Eating / Drinking	13. Computer Equipment / Electronic Games / etc.
2. Passengers	6. Communication Device—Hands Free	10. Reading	14. Adjusting Vehicle Controls
3. Stereo / Audio / Video Equipment	7. Communication Device—Texting / E-mailing	11. Tobacco Use	15. Other (Explain)
4. Navigation Device	8. Communication Device—Web Browsing	12. Grooming	

1. **External Distraction** – Something external to the vehicle or other transport device distracted the **driver** or **non-motorist**. Explain in [Section 9](#).
2. **Passengers** – Passenger(s) in or on the **vehicle, pedalcycle, other transport device, or railway vehicle** distracted the driver or non-motorist.
3. **Stereo / Audio / Video Equipment** – The **driver** or **non-motorist** was distracted using stereo, audio, and/or video equipment. Includes equipment both originally

installed by the vehicle manufacturer and other equipment of this type in the vehicle or other transport device.

4. **Navigation Device** – The [driver](#) or [non-motorist](#) was distracted while viewing or operating a navigation device. This includes GPS or other devices being used for navigation.
  5. **Communication Device – Hand-held** – The [driver](#) or [non-motorist](#) was distracted by using or attempting to use a hand-held mobile communication device to include a mobile telephone.
  6. **Communication Device – Hands Free** – The driver or non-motorist was distracted by using or attempting to use a mobile hands-free communication device. This includes "On-Star" and other similar services.
  7. **Communication Device – Texting / E-mailing** – The [driver](#) or [non-motorist](#) was distracted by texting / e-mailing / etc. on a mobile communication device to include a mobile telephone.
  8. **Communication Device – Web Browsing** – The driver or non-motorist was distracted by web browsing or other application not listed (i.e., games, etc.) on a mobile communication device to include a mobile telephone.
  9. **Eating / Drinking** – The [driver](#) or [non-motorist](#) was distracted by eating or drinking.
  10. **Reading** – The driver or non-motorist was distracted by reading a book, newspaper, magazine, etc.
  11. **Tobacco Use** – The [driver](#) or [non-motorist](#) was distracted by the use of tobacco. This includes the use of a cigarette lighter.
  12. **Grooming** – The driver or non-motorist was distracted by grooming him or herself.
  13. **Computer Equipment / Electronic Games / etc.** – The [driver](#) or [non-motorist](#) was distracted by using computer equipment / electronic games, etc. This does not include use of a mobile telephone as a computing / gaming device.
  14. **Adjusting Vehicle Controls** – The driver was distracted by adjusting vehicle controls. This does not include adjusting radio controls. These should be shown as "Stereo / Audio / Video Equipment."
  15. **Other (Explain)** – The [driver](#) or [non-motorist](#) was distracted by something that is not reflected in the listed attributes. Explain in [9 - Narrative / Statements](#).
- n. **ENDORSEMENTS CODES** – Enter up to two **numerical** codes that indicate the type of endorsement(s) assigned to the driver's license both commercial and non-commercial. For instance, if a [driver](#) has an endorsement of "H - Hazardous Materials," enter "1" in the endorsement field. While the endorsement codes, H, N, P, etc. are nationally standardized, the descriptions for each are intended to serve as a guide and may vary from state to state.

ENDORSEMENTS CODES			
1. H – Hazardous Materials	3. P – Passenger	5. T – Double / Triple Trailers	7. Other Non-commercial License
2. N – Tank Vehicle	4. S – School	6. X – Combination of Tank Vehicle and Hazardous Materials	Endorsements (e.g., Motorcycle, etc.)

**Note:** See [Appendix G - Driver License Status and Type](#) on page 209 in reference to specific situations concerning license status and license type.

1. **H – Hazardous Materials** – Commercial driver license (CDL) classification in which the **driver** is at least 21 years old and has completed the Hazmat written test (new or renewal). Eligible to operate a vehicle carrying hazardous material in placarded quantities.
2. **N – Tank Vehicle** – The **driver** is eligible to operate a tank vehicle – any tank designed to transport liquid or gaseous materials, which has a rated capacity of 1,000 gallons or more. The amount of material actually contained in the tank is irrelevant.
3. **P – Passenger** – The driver is eligible to operate a passenger vehicle (any vehicle designed to transport 16 or more persons, including the operator). The passenger endorsement may be limited to specific commercial motor vehicle classification which will be indicated by placement of a restriction of M or N on the CDL or CLP.
4. **S – School** – License classifications of CDL, CLP, and Class E (for hire) in which the **driver** is 21 years old and:
  - CDL or Class E license holders with S endorsement are eligible to operate a school bus transporting students from school to home, home to school and/or to and from school-sponsored events.
  - CLP with S endorsement allows operation of an empty school bus for training purposes.
  - CDL applicants must have a passenger vehicle “P” endorsement to obtain the school bus “S” endorsement.
  - Class E applicants required to have the school bus “S” endorsement are not required to test for the passenger endorsement.
  - A Class E school bus “S” endorsement cannot be added to a Class A, B or C CDL. The driver must be complete the testing in a CDL class bus to add to a CDL license.
5. **T – Double / Triple Trailers** – A CDL classification in which the **driver** is eligible to operate double / triple trailers (any vehicle pulling double or triple trailers). A Double / Triple Trailer endorsement cannot be issued on a CLP.
6. **X – Combination of Tank Vehicle and Hazardous Materials** – A CDL classification in which the **driver** is at least 21 years old and:
  - Eligible to operate vehicles carrying hazardous materials and tank vehicles. This is a combination of a hazardous materials “H” and tank vehicle “N” endorsement.
  - To add and/or retain a hazardous material / tank “X” endorsement, a driver must apply for and obtain an approved TSA Security Threat Assessment.
  - An “X” endorsement **cannot** be issued on a **CLP permit**.
7. **Other Non-commercial License Endorsements (e.g., Motorcycle, etc.)** – A non-commercial type endorsement such as M – Motorcycle not listed above. These endorsements may be applied to all driver license classifications.

**o. VEHICLE TYPE CODES**

VEHICLE TYPE CODES	
1. Motor Vehicle In Transport	3. Working Motor Vehicle
2. Parked Motor Vehicle	U. Unknown

1. **Motor Vehicle in Transport** – A motor vehicle being used for moving persons or property from one place to another, and is either in motion, in readiness for motion,

or on a roadway, but not parked in a designated area. Includes a motor vehicle moving, stopped, disabled, or abandoned on a roadway other than areas designated for parking. See examples for [Motor Vehicle in Transport](#) in Glossary, page 20.

2. **Parked Motor Vehicle** – A motor vehicle not in-transport, other than a working motor vehicle, that is not in motion and not located on the roadway. A "parked motor vehicle" should be considered to be in-transport during periods when parking is prohibited in roadway lanes used for travel during some periods and for parking during other periods. (See page 33, [Parked MV](#), for inclusions and exclusions).
  3. **Working Motor Vehicle** – A motor vehicle in the act of performing construction, maintenance, or utility work related to the [trafficway](#). This "work" may be located within open or closed portions of the trafficway and motor vehicles performing these activities can be within or outside of the trafficway boundaries. For instance, a utility truck parked off the trafficway in a field placing a concrete culvert on the trafficway. (See page 34, [Working MV](#), for inclusions and exclusions).
- U. **Unknown** – The type of vehicle is unknown.

p. **OTHER VEHICLE CODES**

OTHER VEHICLE CODES		
1. Riding Mower / Garden Tractor	3. Snowmobile	6. Low Speed Vehicle (LSV)
2. Golf Cart	4. Forklift	7. Other (Explain)

1. **Riding Mower / Garden Tractor** – Device originally constructed as a lawn mower or garden tractor.
2. **Golf Cart** – Device originally constructed as an electric or gasoline powered golf cart. This includes any modified or hybrid golf cart converted for transportation use only.
3. **Snowmobile** – A motorized vehicle with runners and a continuous track, used for traveling over snow.
4. **Forklift** – A motorized lifting device with two long rigid steel bars that can be raised and lowered, used especially to move pallets loaded with boxes or other goods.
5. *(Historical code – No longer used.)*
6. **Low Speed Vehicle (LSV)** – A motor vehicle with four or more wheels whose top speed is greater than 20 miles-per-hour, but not greater than 25 miles-per-hour.

LSVs are required to be equipped with basic items of safety equipment: tail lamps, reflex reflectors, parking brake, windshields constructed with safety glass, rearview mirrors, seat belts, and vehicle identification numbers.

7. **Other (Explain)** – Includes all other vehicles that do not fall into the previous categories (e.g., mini-truck). Explain in [Section 9 - Narrative / Statements](#).



(Mini-truck)



q. **VEHICLE ACTION / SEQUENCE OF EVENTS**

VEHICLE ACTION / SEQUENCE OF EVENTS (Items with double-asterisk [**] require additional coding)				
1. Going Straight	11. Backing	21. Ran Off Roadway – Left	30. Collision Inv. Pedestrian (**)	38. Other Non-collision
2. Overtaking	12. Stopped In Traffic	22. Overturn / Rollover	31. Collision Inv. Bicycle / Pedalcycle (**)	41. Collision Inv Working MV
3. Making Right Turn	13. Parked	23. Fire / Explosion	32. Collision Inv. Railway Vehicle	42. Downhill Runaway
4. Right Turn on Red	14. Changing / Merging Lanes	24. Immersion	33. Collision Inv. Animal (**)	43. Fell / Jumped From MV
5. Making Left Turn	15. Avoiding	25. Jackknife	34. Collision Inv. MV in Transport	44. Thrown / Falling Object
6. Making U-Turn	16. Cross Median	26. Cargo / Equipment Loss / Shift	35. Collision Inv Parked MV	46. Ran Off Roadway – Other (Explain)
7. Skidding / Sliding	17. Cross Center Of Road	27. Equipment Failure	36. Collision Inv Fixed Object (**)	47. Cross Separator
8. Slowing / Stopping	18. Cross Road	28. Separation Of Units	37. Collision Inv Other Object (Explain)	48. Collision Inv Other Non-motorist (**)
9. Start In Traffic	19. Airborne	29. Returned To Roadway		49. Struck by Falling / Shifting Cargo, Object Set in Motion by Motor Vehicle
10. Start From Parked	20. Ran Off Roadway – Right			50. End Departure (T-intersection, Dead-end, etc.)

1. **Going Straight** – The **vehicle** was going straight.
2. **Overtaking** – The vehicle was passing another vehicle traveling the same direction.
3. **Making Right Turn** – The vehicle was making a right turn.
4. **Right Turn on Red** – The **vehicle** was making a right turn while controlled by a red traffic signal.
5. **Making Left Turn** – The vehicle was making a left turn.
6. **Making U-Turn** – The vehicle was making a U-turn.
7. **Skidding / Sliding** – The **vehicle** was skidding or sliding.
8. **Slowing / Stopping** – The vehicle was slowing or stopping.
9. **Start in Traffic** – The vehicle was starting (from being stopped) in traffic.
10. **Start From Parked** – The **vehicle** was starting from being parked.
11. **Backing** – The vehicle was backing up.
12. **Stopped in Traffic** – The vehicle was stopped in traffic (not parked).
13. **Parked** – The **vehicle** was parked. See definition of **Parked Motor Vehicle** in the *Glossary on page 21*.
14. **Changing / Merging Lanes** – The vehicle was changing lanes or merging into traffic, such as moving from one lane to another while going the same direction, moving from a straight ahead lane into a turn lane, drifting from one lane into another lane going the same direction, merging into traffic from an entrance **ramp** or from a **shoulder**, etc.
15. **Avoiding** – **Driver** was avoiding an object, other vehicle, animal, etc. When marked, explain what was being avoided in *Section 9 - Narrative / Statements*.
16. **Cross Median** – The **vehicle** traveled completely across the **median**. The vehicle must come into contact with the opposing **road**.
17. **Cross Center of Road** – All, or a portion (mirrors, cargo, etc.), of the vehicle traveled across the center of the road into an opposing lane.
18. **Cross Road** – The **vehicle** was crossing the **road** from another road, private road, etc.

Includes (but is not limited to):

- Vehicle crossing a road from another road at an **intersection**.
- Vehicle out of control crosses an opposing road.

Excludes (but is not limited to):

- Vehicle running off the road and crossing a private drive.
- Vehicle running off the road, overcorrecting, and crossing the same road.
- Vehicle crosses median onto the opposing road / roadway, but does not entirely cross the road / roadway.

19. **Airborne** – The vehicle became airborne.

20. **Ran Off Roadway – Right** – Any part of the vehicle ran off the right side of the roadway. Officer should indicate right or left based on the heading or direction of travel of the vehicle, regardless of the orientation of the vehicle.

Examples:

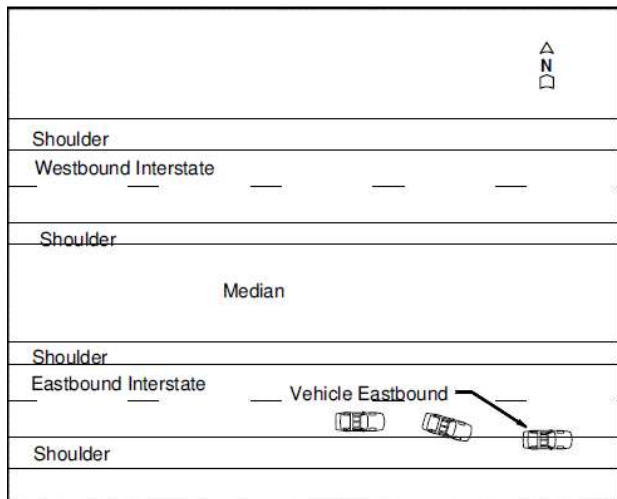

A vehicle going straight on eastbound IS 70 runs across the outside (right) roadway edge line onto the shoulder.

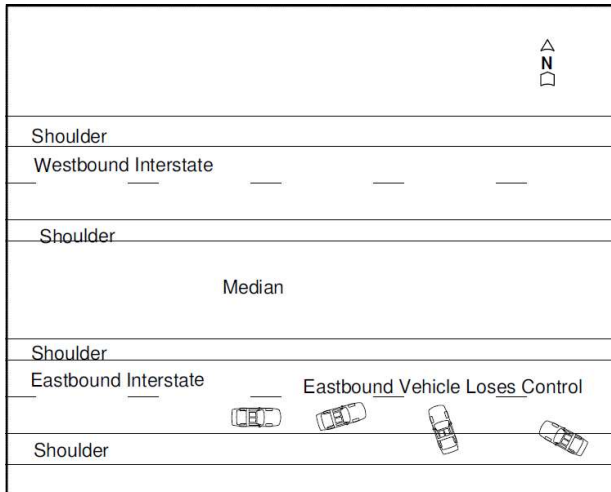

A vehicle going straight on eastbound IS 70 spinning 180 - 360 degrees crosses the outside (right) roadway edge line onto the shoulder.

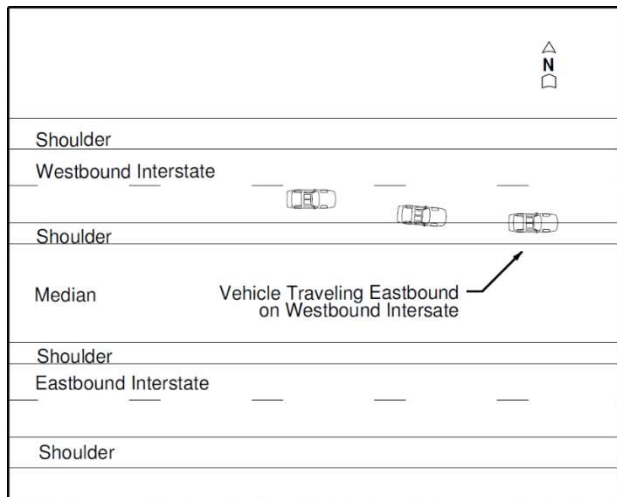

A vehicle going straight the wrong direction eastbound in the westbound lanes of IS 70 runs across the inside / left (westbound) roadway edge line and onto the left shoulder / median.

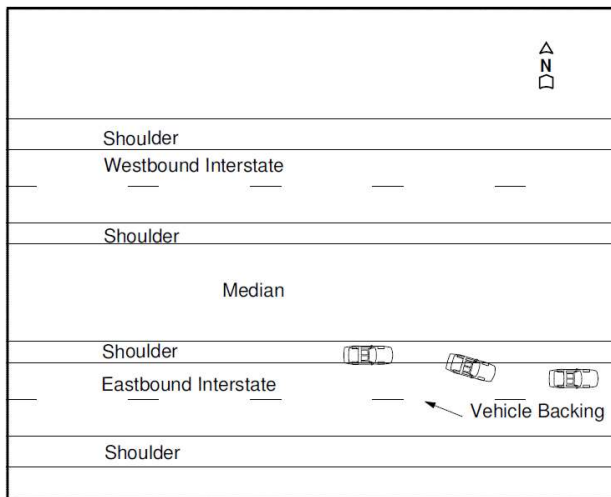

A vehicle backing westbound in the eastbound lanes of IS 70 runs across the inside / left (eastbound) roadway edge line and onto the left shoulder / median.

21. **Ran Off Roadway – Left** – The vehicle ran off the left side of the roadway. Officer should indicate right or left based on the heading or direction of travel, regardless of the orientation of the vehicle.

Examples:

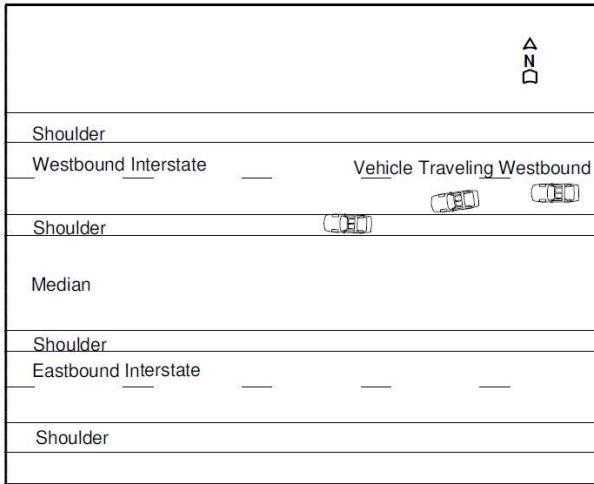

A vehicle going straight on westbound IS 70 runs across the inside (left) roadway edge line onto the shoulder / median.

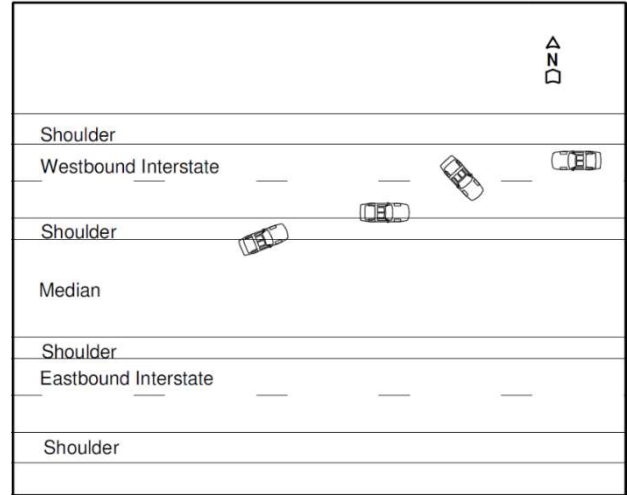

A vehicle going straight on westbound IS 70 spinning 180 - 360 degrees crosses the inside (left) roadway edge line.

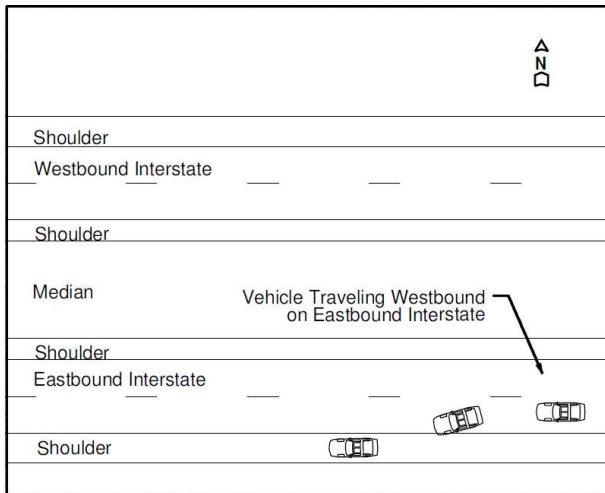

A vehicle going straight the wrong direction westbound in the eastbound lanes of IS 70 runs off the outside / right (eastbound) roadway edge line and onto the right eastbound shoulder.

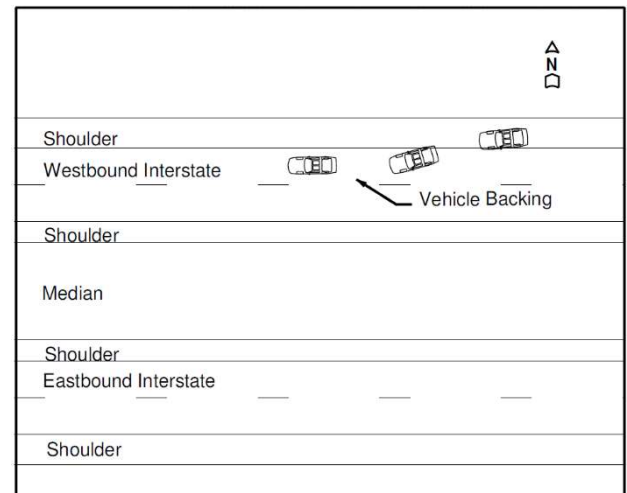

A vehicle backing eastbound in the westbound lanes of IS 70 runs off the outside / right (westbound) roadway edge line and onto the right westbound shoulder.

22. **Overturn / Rollover** – The **vehicle** overturned at least 90 degrees.
23. **Fire / Explosion** – The vehicle caught on fire or exploded.
24. **Immersion** – The **vehicle** became immersed into a liquid resulting in a harmful event.
25. **Jackknife** – An uncontrolled articulation between a vehicle and its trailing unit(s) causing contact and damage to the vehicle and/or trailing unit(s).
26. **Cargo / Equipment Loss / Shift** – The loss or shift of items carried on or in a **motor vehicle** or its trailing unit. **Occupants** are not considered cargo. **Does not apply to snow or ice coming off of the vehicle.**
27. **Equipment Failure** – Failure of the **vehicle's** parts or equipment.
28. **Separation Of Units** – The separation of the power and towed units or separation of towed units.

29. **Returned To Roadway** – All, or a portion (mirrors, cargo, etc.) of the [vehicle](#) returned to the [roadway](#) after running off of the same roadway.
30. **Collision Inv. Pedestrian** – Collision of the vehicle with a [pedestrian](#).
31. **Collision Inv. Bicycle / Pedalcycle** – Collision of the vehicle with a bicycle or [pedalcycle](#).
32. **Collision Inv. Railway Vehicle** – Collision of the [vehicle](#) with a [railway vehicle](#).
33. **Collision Inv. Animal** – Collision of the vehicle with an animal. This includes only live animals. If marked, indicate the type of animal under [Animal Codes](#) in [Subsection 7C](#).  
  
An animal being ridden by a person or harnessed to a conveyance and occupied by a person would be "[Other Non-motorist](#)."
34. **Collision Inv. MV in Transport** – Collision of the [vehicle](#) with a [motor vehicle in transport](#).
35. **Collision Inv. Parked MV** – Collision of the vehicle with a [parked motor vehicle](#).
36. **Collision Inv. Fixed Object** – Collision of the [vehicle](#) with a [fixed object](#). If marked, indicate the fixed object(s) struck under [Fixed Object Code\(s\)](#) in [Subsection 7C](#). See definition of [Fixed Object](#) in the glossary.
37. **Collision Inv. Other Object (Explain)** – Collision of the vehicle with some other non-fixed object.
38. **Other Non-collision** – The code should be used for non-collision crashes where no other non-collision code is applicable.
39. *(Historical code – No longer used.)*
40. *(Historical code – No longer used.)*
41. **Collision Inv. Working MV** – Collision of the [vehicle](#) with a [working motor vehicle](#).
42. **Downhill Runaway** – A downhill runaway of the vehicle.
43. **Fell / Jumped From MV** – An individual/[occupant](#) fell or jumped from a [motor vehicle](#).
44. **Thrown / Falling Object** – The [vehicle](#) is struck by a thrown or falling object. **This excludes contacts with loads or objects set in-motion from/by another motor vehicle in transport.** (See Sequence of Event code 49.)
45. *(Historical code – No longer used.)*
46. **Ran Off Roadway – Other (Explain)** – This is used when the vehicle ran off the [roadway](#) and "Ran Off Roadway – Right" or "Ran Off Roadway – Left" are not applicable. It is also used when "Ran Off Roadway – Right" or "Ran Off Roadway – Left" cannot be determined or is unknown. Explain in [Section 9 - Narrative / Statements](#). Use code "50 – End Departure" when the vehicle leaves the roadway by traveling straight through the top of a "T-intersection" of a two-way trafficway or top of an intersecting one-way roadway.

- 47. **Cross Separator** – The **motor vehicle** traveled completely across the separator. The vehicle must come into contact with the opposing road. See definition of "**separator**" in the glossary.
- 48. **Collision Inv. Other Non-Motorist** – Collision of the **vehicle** with an **other non-motorist**.
- 49. **Struck by Falling, Shifting Cargo or Anything Set in Motion by Motor Vehicle** – A **motor vehicle** "in transport" is struck by **cargo** or anything that is set in motion by a separate motor vehicle resulting in a **harmful event**. A load or cargo that falls from a motor vehicle is considered part of the motor vehicle until the load or cargo comes to rest at which point it becomes an "other object."
- 50. **End Departure** – Is used when the motor vehicle leaves the **roadway** by traveling straight through the top of a "T-intersection" of a two-way **trafficway** or top of an intersecting one-way roadway. This code should also apply to vehicles traveling off the end of dead-end roadways or into the barrier of a closed trafficway. See example in [Appendix E, page 169](#).

r. **ANIMAL CODES FOR VEHICLE ACTION / SEQUENCE OF EVENTS**

ANIMAL CODES FOR VEHICLE ACTION / SEQUENCE OF EVENTS				
60. Deer	61. Farm Animal	62. Dog	63. Other Animal	U. Unknown

- 60. **Deer** – Includes deer only.
- 61. **Farm Animal** – Includes domesticated animals such as a cow, pig, horse, etc.
- 62. **Dog** – Includes domesticated dogs only.
- 63. **Other Animal** – Includes all other animals that do not fall into the previous categories. This includes all wild animals (except deer).
- U. **Unknown** – The investigator has determined that an animal was struck; however, the type of animal cannot be determined.

s. **FIXED OBJECT CODES FOR VEHICLE ACTION / SEQUENCE OF EVENTS**

FIXED OBJECT CODES FOR VEHICLE ACTION / SEQUENCE OF EVENTS				
20. Tree / Stump (Standing)	26. Culvert	32. Building	38. Bridge Rail	44. Wall
21. Embankment / Driveway / Ground / Rock Bluff	27. Highway Traffic Sign Post / Support	33. Traffic Signal Support	39. Guardrail End	45. Cable Barrier
22. Guardrail Face	28. Bridge Pier / Abutment / Support	34. Impact Attenuator / Crash Cushion	40. Other Traffic Barrier	46. Bridge Overhead Structure
23. Utility Pole / Guy Wire	29. Curb	35. Fire Hydrant	41. Overhead Sign Support	47. Overhead Line / Cable
24. Fence	30. Mail Box	36. Other (Explain)	42. Ditch	U. Unknown
25. Street Light Support	31. Concrete Traffic Barrier	37. Bridge Parapet End	43. Other Post / Pole / Support	

- 20. **Tree / Stump (Standing)** – Use this only if the tree or stump is standing. Otherwise, it is considered an "Other Object."
- 21. **Embankment / Driveway / Ground / Rock Bluff** – An embankment is a raised structure to hold back water, to carry or support a roadway, or the result of excavation or washout that may be faced with earth, rock, stone, or concrete.
- 22. **Guardrail Face** – Surface areas along a guardrail stretch other than the ends.

A low barrier running along the edge of the road shoulder either on the right or the left and which has primary longitudinal structure composed of metal (plates, cable,

mesh, box beam, etc.). Guardrails which serve as bridge rails should be marked as "bridge rail."



23. **Utility Pole / Guy Wire** – Constructed for the primary function of supporting an electric line, telephone line, or other electrical-electronic transmission line or cable. It may have lights attached also. This includes guy wires.

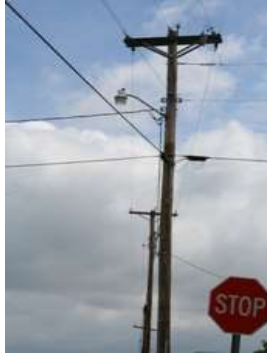

24. **Fence** – A fence can be made of wood, chain link, stone, wire, PVC, etc.; however, does not include shrub hedges serving as containment for property. A "wall" that is part of a fence structure is considered a "fence."
25. **Street light support** – Support poles for roadway lighting. "Utility Pole" should be marked if lines are attached other than power for the light itself.



26. **Culvert** – An enclosed structure providing free passage under a roadway with a clear opening of less than twenty feet in width. If the distance is greater than twenty feet, the structure is considered a bridge.
27. **Highway Traffic Sign Post / Support** – A vertical pole, post, or other type of support for a traffic sign.



Highway Traffic Sign Post / Support

28. **Bridge Pier / Abutment / Support** – Support for a bridge structure including the ends.

A bridge pier is a square or round column of stone, concrete, brick, steel, or wood supporting a bridge between abutments.



A bridge abutment is a wall supporting the ends of a bridge generally retaining or supporting the embankment under bridge ends and composed of stone, concrete, brick, or wood (includes wing walls).

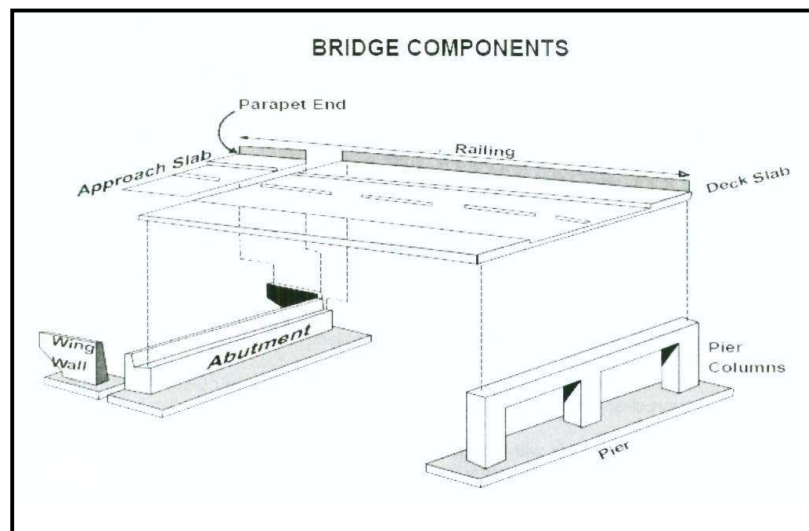

29. **Curb** – A structure composed of concrete, asphalt, brick, etc. that is up to twelve inches in height which borders the roadway, provides drainage control and pavement edge delineation. The face of the curb may be sloped or vertical.



30. **Mailbox** – A public or private box for the collection / delivery of mail. (Dictionary).
31. **Concrete Traffic Barrier** – Longitudinal traffic barriers constructed of concrete and located on the outside of the road surface, in a [median](#), or in gore areas. This includes all temporary concrete barriers regardless of location (e.g., temporary barrier on a bridge being used to control traffic during bridge repair construction).



32. **Building** – A roofed and walled structure for permanent use attached to the terrain. (e.g., house, toll booth, pole barn, portable building attached to the terrain, etc.).
33. **Traffic Signal Support** – A pole, post, or other type of support for a traffic signal. Does not include [work zone](#) traffic control devices.



34. **Impact Attenuator / Crash Cushion** – A device for controlling the absorption of energy released during a vehicle collision ("crash cushions"). Its most common application involves protection of fixed roadside objects such as bridge piers, elevated gores at [ramps](#), etc. Examples include, but are not limited to, barrels filled with water or sand, plastic collapsible structures, collapsible guard rail ends, etc.





- 35. **Fire Hydrant** – A device used to provide water for fire protection.
- 36. **Other (Explain)** – Includes all other fixed objects not listed.
- 37. **Bridge Parapet End** – The end of a low wall which runs along the outermost edge of the roadway or sidewalk on the bridge and usually composed of brick, stone, or concrete. Includes the unprotected end of bridge rail. Does not include any guardrail or impact attenuator / crash cushion attached to the parapet end.

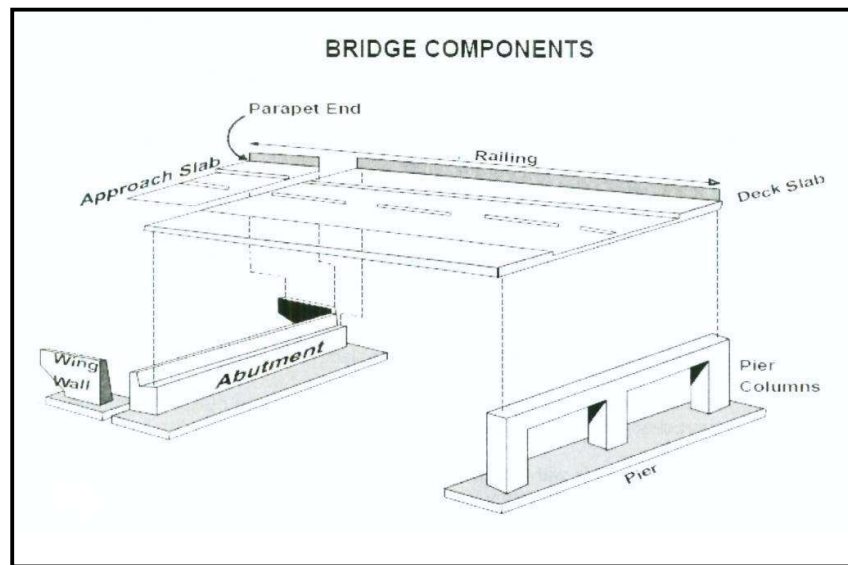

- 38. **Bridge Rail** – A bridge parapet or a barrier attached to a bridge deck to restrain motor vehicles, pedestrians, or other users. This includes guardrails which serve as bridge rails.



39. **Guardrail End** – May be painted a warning color and may include a breakaway or redirection design feature not to be confused with an [impact attenuator / crash cushion](#).



40. **Other Traffic Barrier** – Longitudinal barriers other than guardrails, concrete traffic barriers, or cable barriers. They may be composed of material such as wood or rock.

41. **Overhead Sign Support** – Horizontal support for sign(s).



Overhead Sign Support

42. **Ditch** – Developed primarily to collect and move water.
43. **Other Post / Pole / Support** – Post, pole, or support excluding traffic sign / signal support, utility pole, and street light support.
44. **Wall** – A primarily vertical structure composed of concrete, metal, timber, stone, which is not part of a building or a fence, but typically is used for retaining earth, abating noise, and separating areas, but not for containment as in a primary function of a fence. Also not included are wing walls which are attached to the ends of bridge abutments or culverts and extend back at an angle from the roadway.
45. **Cable Barrier** – A flexible barrier system which uses more than one cable typically supported by steel posts. These can be used on the [roadside](#) or in a [median](#). They are designed to help lesson impact or keep vehicles within the confines of the [road](#).



Cable Barrier

(Source: MMUCC).

**Note:** A single strand cable system should be marked as "Other."

46. **Bridge Overhead Structure** – Any part of a bridge that is over the reference or subject roadway.



47. **Overhead Line / Cable** – Utility line, cable, etc. suspended either along or over the roadway. Excludes lines or cables to traffic signals. These should be marked "Traffic Signal Support."

- U. **Unknown** – The motor vehicle struck a fixed object; however, the type of object could not be determined.

- t. **PROBABLE CONTRIBUTING CIRCUMSTANCES (ITEMS WITH DOUBLE ASTERISK [\*\*] REQUIRE ADDITIONAL CODING** – This subsection is used to record driver errors, vehicle defects, and miscellaneous circumstances that contributed to the crash. Criterion here should not be whether an arrest was made, but that the circumstances existed in the investigator's judgment. Enter all codes associated with probable contributing circumstances that apply and only if it contributed to the crash and not simply that it existed. If "None" or "Unknown" are marked, then no other circumstances can be entered.

PROBABLE CONTRIBUTING CIRCUMSTANCES (Items with double-asterisk [**] require additional coding)		
1. Vehicle Defects (Explain)	10. Improper Signal	19. Drugs
3. Improperly Stopped in Roadway	11. Improper Backing	20. Physical Impairment (Explain)
4. Speed—Exceeded Limit	12. Improper Turn	21. Distracted / Inattentive (**)
5. Too Fast For Conditions	13. Improper Lane Usage / Change	23. Vision Obstructed
6. Improper Passing	14. Wrong Way	24. Driver Fatigue / Asleep
7. Failure to Obey Traffic Signs, Signals, or Officer	15. Improper Start From Park	25. Failed to Dim Headlights
8. Wrong Side (Not Passing)	16. Improperly Parked	26. Failed to Use Lights
9. Following Too Close	17. Failed To Yield	27. Improper Towing / Pushing
	18. Alcohol	28. Overcorrected
		29. Improper Riding / Clinging To Vehicle Exterior
		30. Failed To Secure Load / Improper Loading
		31. Animal(s) In Roadway
		32. Object / Obstruction in Roadway
		33. Other (Explain)

- 1. Vehicle Defects (Explain)** – Mark if motor vehicle defects contributed to the crash. When marked, include an explanation in [Section 9 - Narrative / Statements](#).
- 2. (Historical code – No longer used.)**
- 3. Improperly Stopped in Roadway** – Mark if a motor vehicle in-transport is stopped on a roadway inappropriately or when not directed to do so by a traffic control device or law enforcement officer.
- 4. Speed – Exceeded Limit** – Mark if the motor vehicle was exceeding the speed limit.
- 5. Too Fast for Conditions** – Mark if the motor vehicle's speed was too fast for the conditions at the time of the crash. This includes road, weather, and other conditions. When the speed is both over the speed limit and too fast for conditions, mark only *Speed - Exceeded Limit*.
- 6. Improper Passing** – Mark if an improper pass (overtaking) of another motor vehicle going the same direction contributed to the crash.

7. **Failure to Obey Traffic Signs, Signals, or Officers** – Mark if the **driver** failed to comply with a traffic signal or sign or the direction of an officer. Includes electric signal, stop sign, officer / flagman, yield sign, road closed sign, no passing in a work zone, etc.
8. **Wrong Side (Not Passing)** – Mark if the **motor vehicle** veered across the centerline or was being driven on the wrong side of a two-way street. Does not include driving the wrong way on a one-way street.
9. **Following Too Close** – Mark if the **driver** followed another motor vehicle too closely and this contributed to the crash.
10. **Improper Signal** – Mark if an improper signal by the driver (or no signal when required) contributed to the crash. This includes turn or brake signals, either electronic or hand, but does not include a turn or brake signal failing to operate, which should be shown under "Vehicle Defects" (above).
11. **Improper Backing** – Mark if the **driver** contributed to the crash by improperly backing the **motor vehicle**.
12. **Improper Turn** – Mark if an improper turn on the part of the driver contributed to the crash. A vehicle turning from a straight-only lane would be considered an improper turn. Do not mark in instances where a vehicle is changing from one lane to another, but not turning.
13. **Improper Lane Usage / Change** – Mark if improper lane usage or an improper lane change contributed to the crash. This does not include instances where the **motor vehicle** is making a turning movement. Includes changing lanes and striking another vehicle, going straight in a turn-only lane, etc.
14. **Wrong Way** – Mark if the **motor vehicle** was being driven the wrong way on a one-way street or highway. For instance, a vehicle traveling eastbound in the westbound lanes of a divided highway.
15. **Improper Start from Park** – Mark if the motor vehicle was parked and the improper start from the parked position contributed to the crash.
16. **Improperly Parked** – Mark if the motor vehicle was improperly parked in a place normally designated for parking or improperly parked along the roadway traffic lanes, such as blocking a **driveway**, beside a fire hydrant, or in a loading zone. **Note:** Vehicles that are stopped on the roadway, but not "**parked**" as defined in the glossary, should be shown as "improperly stopped."
17. **Failed to Yield** – Mark if the **driver** failed to yield the right-of-way to another **motor vehicle** or non-occupant/**non-motorist** as required.
18. **Alcohol** – Mark when, in the investigating officer's judgment, use of alcohol by the driver contributed to the crash. This does not indicate intoxication, only that alcohol consumption contributed to the crash. "Yes" under "**Alcohol Use**" (*Subsection 7C*) must be selected if this is marked.
19. **Drugs** – Mark when, in the investigating officer's judgment, use of drugs (legal or illegal) by the **driver** contributed to the crash. This does not indicate intoxication only that drug use contributed to the crash.
20. **Physical Impairment (Explain)** – Mark if a physical condition or impairment on the part of the driver contributed to the crash. Includes illness, but does not include impairment by alcohol or drugs. Wearing glasses is not considered an impairment. However, not wearing glasses when required is a physical impairment. When marked, explain in [Section 9 - Narrative / Statements](#).

21. **Distracted / Inattentive (\*\*)** – Mark if the [driver](#) was distracted or inattentive and it contributed to the crash. **"Distracted / Inattentive Code(s)" must be entered in the appropriate field when this is marked.**

**Note:** "Distracted / Inattentive" only applies to the driver and should not be used as a contributing circumstance on vehicles without a driver. In cases where a non-driver associated with a vehicle was distracted or inattentive, officers should mark "Other" and explain in [Section 9 - Narrative / Statements](#).

22. (Code reserved for when the "None" box is marked. **DO NOT** enter in Subsection 7D.)
23. **Vision Obstructed** – Mark if the driver's vision was obstructed and this contributed to the crash. "NA" or "Unknown" cannot be marked under "Vision Obstructed" (in Subsection 7A) if this is marked. Explain in [Section 9 - Narrative / Statements](#).
24. **Driver Fatigue / Asleep** – Mark if [driver](#) fatigue or falling asleep contributed to the crash.
25. **Failed to Dim Headlights** – Mark if the driver's failure to dim the [motor vehicle's](#) headlights contributed to the crash.
26. **Failed to Use Lights** – Mark if the driver's failure to use the motor vehicle's headlights and/or taillights contributed to the crash.
27. **Improper Towing / Pushing** – Mark if the [driver](#) was improperly towing or pushing another [vehicle](#) and this contributed to the crash.
28. **Overcorrected** – Mark if the driver over-steered in reaction to an event, causing loss of control of the [motor vehicle](#).
29. **Improper Riding / Clinging to Veh. Exterior** – Mark if a [driver](#) or [occupant](#) of the motor vehicle was riding or clinging to the vehicle exterior and this contributed to the crash.
30. **Failed to Secure Load / Improper Loading** – Mark if failure to secure a load on/in the [motor vehicle](#) or improper loading of cargo on/in the vehicle contributed to the crash.
31. **Animal(s) In Roadway** – Mark if animal(s) in the [roadway](#) contributed to the crash. Includes both domestic and wild animals as well as animals in flight such as birds. It also includes animals that are alive.
32. **Object / Obstruction in Roadway** – Mark if an object or obstruction in the roadway contributed to the crash. Includes any item dropped on the roadway from another [vehicle](#), which has come to rest, as well as a dead animal(s) in the roadway. Also includes trees, dirt, etc. deposited on the roadway.
33. **Other (Explain)** – Mark if another unlisted factor contributed to the crash. Explain in [Section 9 - Narrative / Statements](#).



- c. Include vehicle owner information in the narrative when the owner is not included on the report but is pertinent to the investigation.
- d. Include towed unit information in the narrative.
- e. Use [Section 11 - Narrative / Statements Continuation](#) if additional space is needed.
- f. Numbering Roadway Lanes – Engineering standards call for lane numbering on roadways with two or more lanes in the same direction to begin on the inside of the [roadway](#) next to the [median](#) or barrier and progress to the outside lanes (or to the right). This method should be used when referring to lane numbers in the narrative.

Example: Lane one of a roadway with four lanes of travel in the same direction would be the inside lane next to the [median](#) or barrier and lane four would be the outside lane next to the shoulder (or right side of the roadway). See example below.



XI. SECTION 10 – REPORTING AND REVIEWING OFFICER INFORMATION

10. REPORTING AND REVIEWING OFFICER INFORMATION			
REPORTING OFFICER NAME	DSN / BADGE NO.	BEAT / ZONE	TROOP / DISTRICT / PRECINCT
REVIEWING OFFICER NAME	DSN / BADGE NO.	REVIEWING OFFICER 2 NAME	DSN / BADGE NO.

- a. **REPORTING OFFICER NAME** – Print the reporting officer's name.
- b. **DSN / BADGE NO.** – The reporting officer's department serial number (DSN) or badge number.
- c. **BEAT / ZONE** – The reporting officer's beat or zone assignment (if applicable).
- d. **TROOP / DISTRICT / PRECINCT** – The reporting officer's troop, district, or precinct assignment (if applicable).
- e. **REVIEWING OFFICER NAME** – Print the reviewing officer's name.
- f. **DSN / BADGE NO.** – The reviewing officer's department serial number (DSN) or badge number.
- g. **REVIEWING OFFICER 2 NAME** – This is an optional field. It may be used to show any additional officer's review of the report. This may include a reviewing reconstructionist or additional supervisor review.
- h. **DSN / BADGE NO.** – The reviewing officer's department serial number (DSN) or badge number.

XII. SECTION 11 – NARRATIVE / STATEMENTS CONTINUATION

Page Not Used      REPORT # \_\_\_\_\_      PAGE \_\_\_\_\_ OF \_\_\_\_\_

11. NARRATIVE / STATEMENTS CONTINUATION (if additional room is necessary use Narrative / Statements Continuation / Supplement)

This section is used as a continuation of [Section 9 - Narrative / Statements](#).

**PAGE NOT USED** – (Found on back of page containing Sections 8, 9, and 10) Mark if the [Section 11 - Narrative / Statements Continuation](#) page is not utilized. The page should be counted sequentially as part of the report. This block generally used for hard copy crash reports submitted to MOCARS.



# MISSOURI UNIFORM CRASH REPORT CONTINUATION / SUPPLEMENT

## GENERAL INFORMATION

**Note:** [Section 7 - Drivers, Vehicles, Owners, and Occupants](#) must be completed for each [motor vehicle](#) involved in the crash. The standard report includes two pages with this section. Additional pages with this section must be added for crashes involving more than two vehicles. Mark "**Page Not Used**" if a page with [Section 7](#) is not utilized. This is generally applicable to hard copy crash reports submitted to MOCARS versus reports submitted electronically.

MISSOURI UNIFORM CRASH REPORT			<input type="checkbox"/> Continuation	<input type="checkbox"/> Supplement	ORIGINAL REPORT # _____	PAGE _____ OF _____
SUPPLEMENTAL REPORT NO.		SUPPLEMENTAL REPORT DATE		AGENCY NAME AND ORI		
CRASH DATE	TRP / DIST / PCT	COUNTY				
REPORTING OFFICER NAME			DSN / BADGE NO.	SUPPLEMENTAL REVIEWING OFFICER NAME		DSN / BADGE NO.

There are three continuation / supplement forms to the Missouri Uniform Crash Report. These include:

1. Non-motorists / Occupants Continuation / Supplement (SHP-242) – Completed when more than one [non-motorist](#) is involved in a crash or more than five [occupants](#) (including the [driver](#)) from one [vehicle](#) are involved in a crash.
2. Narrative / Statements Continuation / Supplement (SHP-220) – Completed when more space is needed to complete [Section 11 - Narrative / Statements Continuation](#) or when additional narrative information is acquired after the original report has been submitted.
3. Railway Vehicle Continuation / Supplement (SHP-215) – Completed when a [railway vehicle](#) is involved in a motor vehicle crash.

With the exception of the [Railway Vehicle Continuation / Supplement](#), forms are completed according to related field instructions in the original report. Instructions for the [Railway Vehicle Continuation / Supplement](#) begin on [page 137](#).

**Continuation** – Use continuation forms provided by MOCARS to record additional information when space allowed on the standard report is insufficient. Submit continuation forms with the original report as one package. It is not necessary to complete header fields on a continuation form; however, the report / case / incident number is required on each page.

**Supplement** – Use supplement forms provided by MOCARS to record additional information not included in the original report. All header fields must be completed.

**Note:** The MOCARS only needs supplement reports involving fatalities or those significantly altering the original report; however, agencies may send any supplements to MOCARS. Reports must be submitted on forms provided by MOCARS or approved by the Patrol Records Division of the Missouri State Highway Patrol.

### Specific Field Instructions for Continuation / Supplement

Follow the instructions in the front of the manual for fields not listed below.

- I. **CONTINUATION** – Mark if the page is a continuation of, and will be submitted with, the original report.
- II. **SUPPLEMENT** – Mark if the page is a supplement to, and was not submitted with, the original report.

- III. **ORIGINAL REPORT #** – The submitting agency's original report / case / incident number. This must be completed on continuation and supplement forms.
- IV. **PAGE \_\_\_ OF \_\_\_** – The first blank is the page number and second is the total number of pages. Continuations should reflect a continuation of the standard report's page numbers. Supplements should normally begin with "1" and end with the total number of supplemental pages.
- V. **SUPPLEMENT REPORT NO.** – The submitting agency's additional supplement number, if applicable.
- VI. **SUPPLEMENT REPORT DATE** – Enter the date the supplement was completed.
- VII. **AGENCY NAME AND ORI** – Enter agency name and Originating Agency Identifier (ORI) number of the agency completing the supplement. Other information pertinent to the department may be shown here.
- VIII. **CRASH DATE** – Enter the date the crash occurred.
- IX. **TRP / DIST / PCT** – Enter the appropriate number(s) or letter(s) to indicate the troop, district, or precinct in which the crash occurred. Enter "NA" if this field is not applicable.
- X. **COUNTY** – Enter the name of the county in which the crash occurred. Exception: Crashes occurring in the City of St. Louis enter "St. Louis City."
- XI. **REPORTING OFFICER NAME** – Print the reporting officer's name.
- XII. **DSN / BADGE NO.** – The reporting officer's department serial number (DSN) or badge number.
- XIII. **SUPPLEMENTAL REVIEWING OFFICER NAME** – Print the officer's name who reviewed the supplemental report.
- XIV. **DSN / BADGE NO.** – The reviewing officer's department serial number (DSN) or badge number.
- XV. See [Section 5 Non-Motorist](#) of this manual (*page 54*) for instructions on completing the Non-motorist fields of the continuation / supplement forms.

See [Section 7 - Drivers, Vehicles, Owners, & Occupants](#) of this manual (*page 94*) for instructions on completing the occupant fields of the continuation / supplement forms.

See [Section 9 - Narrative / Statements](#) of this manual (*page 132*) for instructions on completion of this field of the continuation / supplement forms.



## I. GENERAL CRASH INFORMATION

- a. **CONTINUATION** – Mark if the page is a continuation of, and will be submitted with, the original report.
- b. **SUPPLEMENT** – Mark if the page is a supplement to, and was not submitted with, the original report.
- c. **ORIGINAL REPORT #** – The submitting agency's original report / case / incident number. This must be completed on continuation and supplement forms.
- d. **PAGE \_\_\_ OF \_\_\_** – The first blank is the page number and second is the total number of pages. Continuations should reflect a continuation of the standard report's page numbers. Supplements should normally begin with "1" and end with the total number of supplemental pages.
- e. **SUPPLEMENT REPORT NO.** – The submitting agency's additional supplement number, if applicable.
- f. **SUPPLEMENT REPORT DATE** – Enter the date the supplement was completed.
- g. **AGENCY NAME AND ORI** - Enter agency name and Originating Agency Identifier (ORI) number of the agency completing the supplement. Other information pertinent to the department may be shown here.
- h. **CRASH DATE** – Enter the date the crash occurred.
- i. **TRP / DIST / PCT** – Enter the appropriate number(s) or letter(s) to indicate the troop, district, or precinct in which the crash occurred. Enter "NA" if this field is not applicable.
- j. **COUNTY** – Enter the name of the county in which the crash occurred. Exception: Crashes occurring in the City of St. Louis enter "St. Louis City."
- k. **REPORTING OFFICER NAME** – Print the reporting officer's name.
- l. **DSN / BADGE NO.** – The reporting officer's department serial number (DSN) or badge number.
- m. **SUPPLEMENTAL REVIEWING OFFICER NAME** – Print the officer's name who reviewed the supplemental report.
- n. **DSN / BADGE NO.** – The reviewing officer's department serial number (DSN) or badge number.

## II. TRAIN INFORMATION

- a. **VEH NO.** – The [vehicle](#) number assigned by the investigator.
- b. **TRAIN ID NUMBER** – Enter the identification number on a [train](#). This is normally available from the conductor. Enter "NA" if this is a retractable flange wheeled vehicle.
- c. **LEAD ENGINE NO.** – The train lead engine number. This is often stenciled in large numbers on the side of the lead engine. It is not the same as the Train ID Number. Enter "NA" if this is a retractable flange wheeled vehicle.
- d. **MAKE** – The [train](#) lead engine or retractable flange wheeled motor vehicle manufacturer. If not available or unknown, enter "Unknown."

e. **MODEL** – The train lead engine or retractable flange wheeled motor vehicle model name or number. If not available or unknown, enter "Unknown."

f. **LOCOMOTIVE ENGINEER CERTIFICATE**

- i. **Yes** – Mark if the engineer is able to produce his/her locomotive engineer certificate.
- ii. **No** – Mark if the engineer is unable to produce or does not have a locomotive engineer certificate. Mark if the operator is not required to have a certificate. (Note: Only locomotive engineers are required to have an Engineer's Certificate).
- iii. **Expiration Date** – Enter the expiration date of the engineer's locomotive engineer certificate (if available). Enter "NA" if unknown, not available, or a certificate is not required.

g. **RETRACTABLE FLANGE WHEELED MOTOR VEHICLE**

Completed when a rail maintenance vehicle (pickups, heavy duty trucks, etc.) with retractable flange wheels, which can be operated either on rails or a [roadway](#), is involved in the crash.

- i. **NA** – Mark if a retractable flange wheeled motor vehicle is not involved. If marked, all other fields pertaining to the retractable flange wheeled motor vehicle must be blank.
- ii. **VEH. YEAR** – Enter four-digit vehicle model year. If in doubt, use year indicated on title or as obtained from the Department of Revenue.
- iii. **LICENSE-PLATE NO.** – Enter the state license plate number, if licensed. Enter "NOTREQ" if no license plate is displayed.
- iv. **STATE** – Enter state / province issuing the vehicle license using the standard NCIC two letter abbreviation as shown in [Appendix C - United States, Canada, and Mexico Abbreviations, page 155](#). Enter "XX" for licenses issued by entities not listed in the appendix. Enter "NA" if no license plate is displayed.
- v. **YEAR** – Enter four-digit year designation of plate. Enter the current year for license plates not displaying a year. Enter "NA" if no license plate is displayed.
- vi. **VIN** – Enter the vehicle identification number (VIN) as shown on the vehicle.
- vii. **COLOR** – Enter the vehicle color(s) starting at the top. Use [NCIC codes](#) on [page 73](#). Example: "BLK" | "RED" indicates the vehicle is predominately black on top and red on the bottom.

h. **HEADLIGHT IN USE**

- i. **Yes** – Mark if the [railway vehicle's](#) headlight(s) was illuminated at the time of the crash.
- ii. **No** – Mark if the railway vehicle's headlight(s) was not illuminated at the time of the crash.
- iii. **Unknown** – Mark if the investigator could not determine if the [railway vehicle's](#) headlight(s) was illuminated at the time of the crash.

i. **HORN IN USE**

- i. **Yes** – Mark if the railway vehicle's horn was sounding just prior to or during the crash.
- ii. **No** – Mark if the **railway vehicle's** horn was not sounding just prior to or during the crash.
- iii. **Unknown** – Mark if the investigator could not determine if the horn was sounding just prior to or during the crash.

j. **BELL IN USE**

- i. **Yes** – Mark if the **railway vehicle's** bell was sounding just prior to or during the crash.
- ii. **No** – Mark if the railway vehicle's bell was not sounding just prior to or during the crash or if the vehicle is not equipped with a bell.
- iii. **Unknown** – Mark if the investigator could not determine if the bell was sounding just prior to or during the crash.

k. **TOTAL NO. OF OCCUPANTS** – The total number of occupants of the **railway vehicle**. Occupants include engineer, conductor, train crew members, and passengers.

l. **TRAIN DAMAGE** – Indicate **damage** sustained by the **railway vehicle**, if any, during the crash.

- i. **None / no damage** – Mark if the railway vehicle (including any engine or cars and / or cargo) was not damaged.
- ii. **Initial impact no.** – Enter the number corresponding to the initial impact point on the train lead engine. If the initial impact point was on another engine or cars, enter #21. If initial impact was to the cargo, enter #22. "NA" cannot be entered in this field.
- iii. **Vehicle damage** – Circle number(s) corresponding to the damaged areas of the train lead engine. If there was damage to other engines or cars, circle #21.

m. **NO. OF CARS** – The total number of engines and cars in the train. This is available from the conductor. This cannot be "0".

n. **SPEED** – The estimated speed of the train at the time of collision. This is available from the engineer.

o. **DISTANCE FROM IMPACT AREA TO FRONT OF LEAD ENGINE** – The distance from the area of impact to the front of the lead engine at its final resting position.

p. **RAILROAD CO. – TRACKS**

**OWNER NAME AND ADDRESS** – The railroad tracks owner's name and address. This is available from the conductor.

q. **RAILROAD CO. – TRAIN**

**OWNER NAME AND ADDRESS** – The train owner's name and address. This is available from the conductor.

III. **TRAFFIC CONTROL DEVICE AT CROSSING INFORMATION**

- a. **NA** – Mark if the crash did not occur at a railroad crossing.

- b. **TRAFFIC CONTROL DEVICE AT CROSSING** – Mark up to three types of crossing signals present at the scene. This indicates only the presence of the signals, not whether they were operating at the time of the crash.
  - i. **LIGHTS / GATES / BELL COMBINATION** – Mark if there is a combination of warning lights, crossing gates and bells at the crossing.

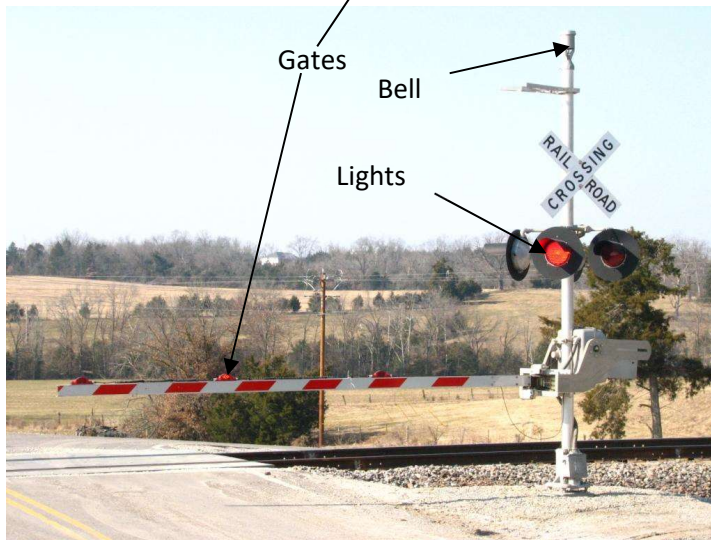
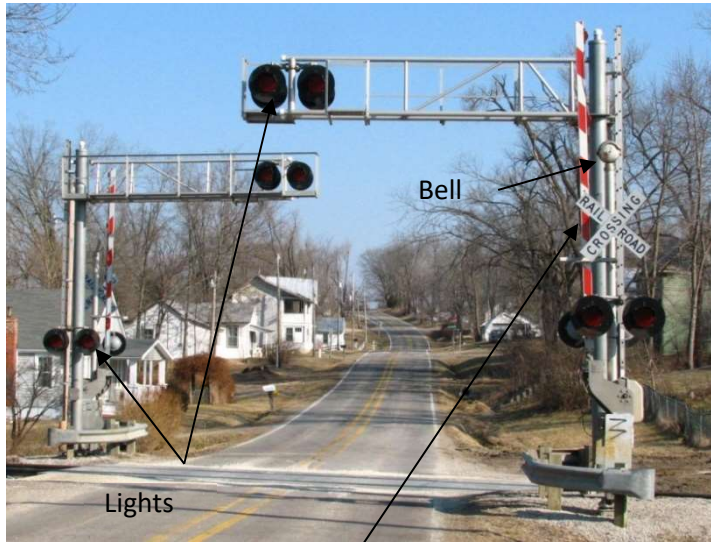

- ii. **LIGHTS / BELL COMBINATION** – Mark if there is a combination of warning lights and bells at the crossing.
- iii. **PASSIVE WARNING (CROSSBUCKS ONLY)** – Mark if there are only passive warnings at the crossing. This normally consists of cross bucks.



- iv. **LIGHTS / GATES** – Mark if there is a combination of warning lights and crossing gates at the crossing.
- v. **LIGHTS ONLY** – Mark if there are warning lights at the crossing, but no bells or gates.
- vi. **PAVEMENT MARKINGS** – Mark if there are pavement markings warning of the approaching crossing.



- vii. **FLAGMAN** – Movement of traffic at the railroad crossing is directed by a flagman.
- viii. **NONE** – Mark if the crash occurred at a railroad crossing; however, there were no crossing signals of any type.

**c. UPON INVESTIGATING OFFICER'S ARRIVAL AT SCENE**

**i. Crossing gates down**

- 1. **Yes** – Mark to indicate crossing gates were installed and down across the roadway.
- 2. **No** – Mark to indicate crossing gates were installed and up.
- 3. **NA** – Mark if there were no crossing gates installed at the crossing or the crash did not occur at a crossing.

**ii. Lights flashing**

- 1. **Yes** – Mark to indicate crossing lights were installed and flashing.
- 2. **No** – Mark to indicate crossing lights were installed and not flashing.
- 3. **NA** – Mark if there were no flashing lights installed at the crossing or the crash did not occur at a crossing.

**iii. Bells ringing**

- 1. **Yes** – Mark to indicate crossing bells were installed and ringing.
- 2. **No** – Mark to indicate crossing bells were installed and not ringing.
- 3. **NA** – Mark if there were no crossing bells installed at the crossing or the crash did not occur at a crossing.

**d. ADVANCE WARNING SIGNS IN PLACE**

- i. **Yes** – Mark if there were signs warning the driver of the involved motor vehicle that a railroad crossing was ahead.

Includes (but is not limited to):





- ii. **No** – Mark if there were no advance warning signs in place.
  - iii. **NA** – Mark if this field is not applicable to the crash, i.e., private road, crash not at a crossing, etc.
- e. **DISTANCE FROM SIGN TO NEAREST RAIL** – If advance warning signs were present, measure and enter the distance from the nearest rail to the farthest warning sign based on the involved motor vehicle's direction of travel.
- i. **NA** – Mark if there were no advance warning signs in place.
  - ii. **Miles** – Mark if the distance recorded was in miles.
  - iii. **Feet** – Mark if the distance recorded was in feet.
- f. **CROSSING SURFACE** – Identify the surface type within the crossing, i.e., rubber, wood, asphalt, concrete, etc.
- NA** - Mark if the crash did not occur at a crossing.
- g. **DOT / AAR CROSSING ID. NO.** – Enter the DOT / AAR Crossing Identification Number located on the crossing control box and/or cross bucks.



- NA** – Mark if the crash did not occur at a crossing or there was no control box and/or cross bucks present at the crossing.
- h. **QUIET ZONE**
- i. **Yes** – Mark if the crash occurred in a quiet zone established by local ordinance.
  - ii. **No** – Mark if the crash did not occur in a quiet zone.
  - iii. **Unknown** – Mark if the investigator is unable to determine if the crash occurred in a quiet zone.

IV. **TRAIN ACTION / SEQUENCE OF EVENTS CODES** – This field describes the [railway vehicle action\(s\)](#) from just prior to the first [unstabilized event](#) to final rest. All [sequence of events](#), [animal codes](#), and [fixed object codes](#) must be explained in [Section 9 - Narrative / Statements](#). All codes are listed in [Section 8 - Codes](#), page 119.

- a. **Additional Codes Listed In Narrative** – Mark if there are more than ten sequence of events codes. Codes in excess of ten should be listed in [Section 9 - Narrative / Statements](#).
- b. **Unknown** – Mark if the [railway vehicle's sequence of events](#) cannot be determined.
- c. **Sequence of Events Codes** – Starting with the [railway vehicle's](#) actions just prior to the first [unstabilized event](#), identify chronological events associated with the railway vehicle. Write the code for the first event in the first block, second in the second block, etc. Use the codes listed in [Section 8 - Codes](#). For a description of the codes, refer to [Section 8 - Codes](#) in this manual ([page 119](#)).

**Note:** Vehicle action code number "34" (Collision Involving a [Motor Vehicle in Transport](#)) must be shown in the sequence of events in order for it to be considered a motor vehicle crash. The [first harmful event](#) in the sequence must be between the [railway vehicle](#) and a motor vehicle in transport.

**Note:** Animal and fixed object codes are not applicable and documentation of the codes is not required; however, this information must be documented in [Section 9 - Narrative / Statements](#).

- d. **DISTRACTED / INATTENTIVE CODE(S)** – This identifies the type of distraction(s) involved when "Distracted / Inattentive" is selected as a probable contributing circumstance. Up to four can be entered. Use the codes listed in [Section 8 - Codes](#). For a description of the codes, refer to [Section 8 - Codes](#) in this manual ([page 115](#)). Explain cause of the distraction in [Section 9 - Narrative / Statements](#).

**Not Applicable** – Mark if "Distracted / Inattentive" was not marked as a probable contributing circumstance.

## V. PROBABLE CONTRIBUTING CIRCUMSTANCES

This field is used to record contributing engineer / operator errors, [railway vehicle](#) defects, and miscellaneous circumstances. Criterion here should be based on whether the circumstances existed in the investigator's judgment, and it contributed to the crash. Mark all that apply. If "None," or "Unknown" are marked, then no other circumstances may be marked.

- a. **NONE** – Mark only if, in the investigating officer's opinion, there were no probable contributing circumstances associated with the railway vehicle. When marked, no other circumstances may be marked.
- b. **TRAIN DEFECTS (EXPLAIN)** – Includes [railway vehicle](#) defects that may have contributed to the crash. When marked, include an explanation in [Section 9 - Narrative / Statements](#).
- c. **EXCESSIVE SPEED** – The railway vehicle exceeded the recommended speed limit for the section of track where the crash occurred.

**Note:** The recommended speed limit is set by various regulatory authorities.

- d. **VIOLATION SIGNAL / SIGN** – Failing to comply with railway signals / signs directing movement of the [railway vehicle](#).
- e. **ALCOHOL** – Includes instances when, in the investigating officer's judgment, use of alcohol by the engineer / operator contributed to the crash. This does not indicate intoxication, only that alcohol consumption contributed to the crash.
- f. **DRUGS** – Includes instances when, in the investigating officer's judgment, use of drugs (legal or illegal) by the engineer / operator contributed to the crash. This does not indicate intoxication, only that drug use contributed to the crash.

- g. **VISION OBSTRUCTED** – Mark if the engineer's / operator's vision was obstructed and this contributed to the crash. Explain in [Section 9 - Narrative / Statements](#).
- h. **OPERATOR FATIGUE / ASLEEP** – Mark if engineer / operator fatigue or falling asleep contributed to the crash.
- i. **FAILED TO SOUND HORN** – Mark if the engineer / operator failed to sound the railway vehicle's horn when required and this contributed to the crash.
- j. **FAILED TO USE LIGHTS** – Mark if light(s) on the railway vehicle were not illuminated at the time of the crash and this contributed to the crash.
- k. **OBSTRUCTION ON TRACKS** – Mark if an obstruction on or near the tracks contributed to the crash.
- l. **TRACK DEFECTS (Explain)** – Mark if track defect(s) contributed to the crash. Explain in [Section 9 - Narrative / Statements](#).
- m. **IMPROPER RIDING / CLINGING TO TRAIN EXTERIOR** – Mark if an engineer / operator or occupant of the [railway vehicle](#) was riding or clinging to the vehicle exterior and this contributed to the crash.
- n. **FAILED TO SECURE LOAD / IMPROPER LOADING** – Mark if failure to secure a load on / in the railway vehicle or improper loading of cargo on / in the railway vehicle contributed to the crash.
- o. **DERAILMENT** – Mark if derailment of a [railway vehicle](#) contributed to the crash.
- p. **DISTRACTED / INATTENTIVE** – Mark if the engineer / operator was distracted or inattentive and it contributed to the crash. **"Distracted / Inattentive Code(s)" must be entered when this is marked.**
- q. **UNKNOWN (EXPLAIN)** – Mark if it is unknown whether actions on the part of the engineer / operator contributed to the crash or if there was not enough evidence at the scene to ascertain who or what contributed. If marked, no other selections can be made. Explain in [Section 9 - Narrative / Statements](#).
- r. **OTHER (EXPLAIN)** – Mark if another unlisted factor on the part of the [railway vehicle](#) contributed to the crash. Explain in [Section 9 - Narrative / Statements](#).

VI. **ENGINEER** – The operator of the [railway vehicle](#).

- a. **ENGINEER'S – NAME (LAST, FIRST, MI)** – Enter current legal name using last name, first name, and middle initial format. (**Note:** Do not enter a period after the middle initial).
- b. **ADDRESS (STREET, CITY, STATE, ZIP)** – Enter current address on the line below the name.
- c. **DATE OF BIRTH (MM-DD-YYYY)** – Enter the engineer's birth date in month, day, and year (mm-dd-yyyy) format.
- d. **SEX** – Enter "M" for male, "F" for female, "U" if the information is unknown, and "N" if there is no engineer.
- e. **SEAT LOC.** – (Seat Location) Enter the code "RC" (Rail Crew) for the engineer's seat location. "NA" is entered only if there was no engineer.

**Note:** Use actual seat locations (FL, FR, FC, etc.) for rail maintenance vehicles (pickups, heavy duty trucks, etc.) with retractable flange wheels, which can be operated either on

rails or a roadway. Use the codes listed in [Section 8 - Codes](#). For a description of the codes, refer to [Section 8 - Codes](#) in this manual (*page 105*).

- f. **INJ – (Injury)** Enter one code to indicate the injury severity. Use the codes listed in [Section 8 - Codes](#). For a description of the codes, refer to [Section 8 - Codes](#) in this manual (*page 106*). "N" (NA) may be entered only if there was no engineer.

**Note:** Injuries should be classified on the basis of conditions at the scene of the crash. The exception to this rule applies to fatal injuries (*late death*). Injuries that do not meet these criteria may be documented in [Section 9 - Narrative / Statements](#).

Enter "5" (None Apparent) for engineers who are not injured, but transported from the scene to a medical facility for precautionary measures. Explain in [Section 9 - Narrative / Statements](#).

- g. **TRANSPORT** – Enter one code to indicate whether and how the engineer was transported from the scene to a medical facility for treatment of crash-related injuries. "N" (NA) may be entered only if there was no engineer. Use the codes listed in [Section 8 - Codes](#). For a description of the codes, refer to [Section 8 - Codes](#) in this manual (*page 108*).

List the name of the transporting agency or person, and medical facility they were transported to in [Section 9 - Narrative / Statements](#) if applicable.

**Note:** Enter "1" (No) for an engineer who is not injured, but transported from the scene to a medical facility for precautionary measures. In addition, mark "No" if an engineer deceased at the scene is transported. In either case, explain in [Section 9 - Narrative / Statements](#).

- h. **EJECTION** – Enter one code to indicate whether the engineer was ejected from the railway vehicle or if the field is not applicable. "N" (NA) may be entered only if there was no engineer. Use the codes listed in [Section 8 - Codes](#). For a description of the codes, refer to [Section 8 - Codes](#) in this manual (*page 108*).
- i. **AIR BAG** – Enter up to four codes to indicate if air bags were present for the engineer and whether any airbags were deployed. Use the codes listed in [Section 8 - Codes](#). For a description of the codes, refer to [Section 8 - Codes](#) in this manual (*page 109*).
- j. **SAFETY DEVICES** – Enter one or two codes to indicate the type of [safety device](#) used, if any, by the engineer. Use the codes listed in [Section 8 - Codes](#). For a description of the codes, refer to [Section 8 - Codes](#) in this manual (*page 110*).
- k. **PHONE NUMBER** – Enter the engineer's telephone number, including the area code.

## VII. CONDUCTOR

- a. **CONDUCTOR'S – NAME (LAST, FIRST, MI)** – Enter current legal name using last name, first name, and middle initial format. (**Note:** Do not enter a period after the middle initial).
- b. **ADDRESS (STREET, CITY, STATE, ZIP)** – Enter current address on the line below the name.
- c. **DATE OF BIRTH (MM-DD-YYYY)** – Enter the conductor's birth date in month, day, and year (mm-dd-yyyy) format.
- d. **SEX** – Enter "M" for male, "F" for female, or "U" if the information is unknown.
- e. **SEAT LOC.** – (Seat Location) Enter the code "RC" (Rail Crew) for the conductor's seat location.

**Note:** Use actual seat locations (FL, FR, FC, etc.) for rail maintenance vehicles (pickups, heavy duty trucks, etc.) with retractable flange wheels, which can be operated either on rails or a roadway. Use the codes listed in [Section 8 - Codes](#). For a description of the codes, refer to [Section 8 - Codes](#) in this manual (*page 105*).

- f. **INJ – (Injury)** Enter one code to indicate the injury severity. Use the codes listed in [Section 8 - Codes](#). For a description of the codes, refer to [Section 8 - Codes](#) in this manual (*page 106*).

**Note:** Injuries should be classified on the basis of conditions at the scene of the crash. The exception to this rule applies to fatal injuries (*late death*). Injuries that do not meet these criteria may be documented in [Section 9 - Narrative / Statements](#).

Enter "5" (None Apparent) for conductors who are not injured, but transported from the scene to a medical facility for precautionary measures. Explain in [Section 9 - Narrative / Statements](#).

- g. **TRANSPORT** – Enter one code to indicate whether and how the conductor was transported from the scene to a medical facility for treatment of crash-related injuries. Use the codes listed in [Section 8 - Codes](#). For a description of the codes, refer to [Section 8 - Codes](#) in this manual (*page 108*).

List the name of the transporting agency or person, and medical facility they were transported to in [Section 9 - Narrative / Statements](#) if applicable.

**Note:** Enter "1" (No) for a conductor who is not injured, but transported from the scene to a medical facility for precautionary measures. In addition, mark "No" if a conductor deceased at the scene is transported. In either case, explain in [Section 9 - Narrative / Statements](#).

- h. **EJECTION** – Enter one code to indicate whether the conductor was ejected from the railway vehicle or if the field is not applicable. Use the codes listed in [Section 8 - Codes](#). For a description of the codes, refer to [Section 8 - Codes](#) in this manual (*page 108*).
- i. **AIR BAG** – Enter up to four codes to indicate if air bags were present for the conductor and whether any airbags were deployed. Use the codes listed in [Section 8 - Codes](#). For a description of the codes, refer to [Section 8 - Codes](#) in this manual (*page 109*).
- j. **SAFETY DEVICES** – Enter one or two codes to indicate the type of [safety device](#) used, if any, by the conductor. Use the codes listed in [Section 8 - Codes](#). For a description of the codes, refer to [Section 8 - Codes](#) in this manual (*page 110*).
- k. **PHONE NUMBER** – Enter the conductor's telephone number, including the area code.

## VIII. TRAIN CREW MEMBERS & PASSENGERS

- a. **TRAIN CREW MEMBER'S OR PASSENGER'S – NAME (LAST, FIRST, MI)** – Enter current legal name using last name, first name, and middle initial format. (**Note:** Do not enter a period after the middle initial).
- b. **ADDRESS (STREET, CITY, STATE, ZIP)** – Enter current address on the line below the name.
- c. **DATE OF BIRTH (MM-DD-YYYY)** – Enter the individual's birth date in month, day, and year (mm-dd-yyyy) format.
- d. **SEX** – Enter "M" for male, "F" for female, or "U" if the information is unknown.

- e. **SEAT LOC.** – (Seat Location) Enter the code "RC" (Rail Crew) or "CP" (Commercial Passenger) for seat locations.

**Note:** Use actual seat locations (FL, FR, FC, etc.) for rail maintenance vehicles (pickups, heavy duty trucks, etc.) with retractable flange wheels, which can be operated either on rails or a roadway. Use the codes listed in [Section 8 - Codes](#). For a description of the codes, refer to [Section 8 - Codes](#) in this manual (*page 105*).

- f. **INJ** – (*Injury*) Enter one code to indicate the injury severity. Use the codes listed in [Section 8 - Codes](#). For a description of the codes, refer to [Section 8 - Codes](#) in this manual (*page 106*).

**Note:** Injuries should be classified on the basis of conditions at the scene of the crash. The exception to this rule applies to fatal injuries (*late death*). Injuries that do not meet these criteria may be documented in [Section 9 - Narrative / Statements](#).

Enter "5" (None Apparent) for those who are not injured, but transported from the scene to a medical facility for precautionary measures. Explain in [Section 9 - Narrative / Statements](#).

- g. **TRANSPORT** – Enter one code to indicate whether and how this individual was transported from the scene to a medical facility for treatment of crash-related injuries. Use the codes listed in [Section 8 - Codes](#). For a description of the codes, refer to [Section 8 - Codes](#) in this manual (*page 108*).

List the name of the transporting agency or person, and medical facility they were transported to in [Section 9 - Narrative / Statements](#) if applicable.

**Note:** Enter "1" (No) for those who are not injured, but transported from the scene to a medical facility for precautionary measures. In addition, mark "No" if a person deceased at the scene is transported. In either case, explain in [Section 9 - Narrative / Statements](#).

- h. **EJECTION** – Enter one code to indicate whether the person was ejected from the railway vehicle. Use the codes listed in [Section 8 - Codes](#). For a description of the codes, refer to [Section 8 - Codes](#) in this manual (*page 108*).
- i. **AIR BAG** – Enter up to four codes to indicate if air bags were present for the individual and whether any airbags were deployed. Use the codes listed in [Section 8 - Codes](#). For a description of the codes, refer to [Section 8 - Codes](#) in this manual (*page 109*).
- j. **SAFETY DEVICES** – Enter one or two codes to indicate the type of [safety device](#) used, if any, by the individual. Use the codes listed in [Section 8 - Codes](#). For a description of the codes, refer to [Section 8 - Codes](#) in this manual (*page 110*).
- k. **PHONE NUMBER** – Enter the individual's telephone number, including the area code.

# APPENDIX A

## Short Form Information

SHORT FORM REQUIRED FIELDS – Following is a list of required short form fields. These fields have captions or borders shaded gray.

### Section 1

Agency Name and ORI  
Property Damage Only  
Report / Case / Incident Number  
No. Veh. Inv.  
Crash Date  
Crash Time (Mil.)  
Notified Date  
Time Notified (Mil.)  
Invest. Date  
Time Arrived (Mil.)  
Date of Rdwy. Clear  
Time of Rdwy. Clear  
Investigated at Scene  
Crash Type  
Commercial Motor Vehicle Involvement  
Criteria

### Section 2

County  
Municipality  
Beat / Zone  
Trp / Dist / Pct  
GPS Coordinates  
On  
Rdwy. Dir.  
Distance From  
Location  
Intersecting  
Speed Limit ("On" Roadway)  
Roadway Maintained By  
Speed Limit ("Intersecting" Roadway)  
Int. Dir.  
Geo-Code  
Roadway Condition  
Light Condition

### Section 3

Damage to Property Other Than Vehicles

### Section 6

Collision Diagram

### Section 7

Driver - No.  
Driver - Name & Address  
Driver - Date of Birth  
Driver - Air Bag  
Driver - Safety Devices  
Proof of Insurance  
Insurance Company  
Driver / Vehicle Insured  
Vehicle Owner's Name & Address  
License Plate No.  
License State  
VIN  
Towed from Scene

Towed Due to Dis. Damage  
Towed By  
Vehicle Damage  
Initial Impact  
Vehicle Body Types  
First & Second Trailer Towed Unit - License  
Plate No. (If applicable)  
First & Second Trailer Towed Unit - State  
First & Second Trailer Towed Unit - VIN  
Contributing Traffic Conditions  
Sequence of Events  
Animal Codes (If applicable)  
Fixed Object Codes (If applicable)  
Probable Contributing Circumstances  
Distraction / Inattention Codes (If applicable)  
Work Zone  
Type of Work Zone  
Location of the Crash  
Law Enforcement Present  
Traffic Control  
Control Malfunctioning / Inoperative /  
Missing

### Section 9

Narrative / Statements









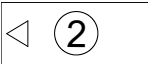

### Section 10

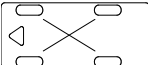
Reporting Officer Name  
DSN / Badge No.  
Beat / Zone  
Troop / District / Precinct  
Reviewing Officer Name  
DSN / Badge No.

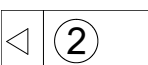

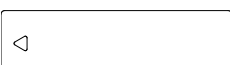

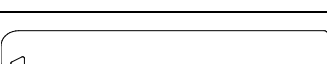
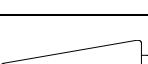
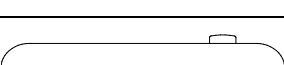
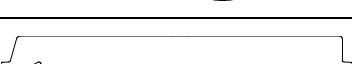







## APPENDIX B Diagramming Methods

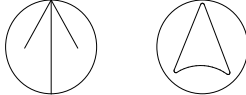
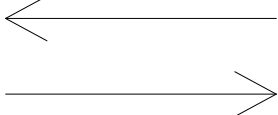



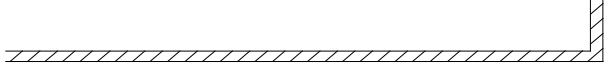



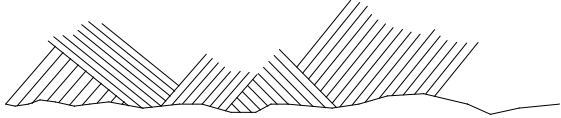
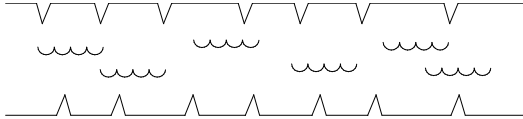

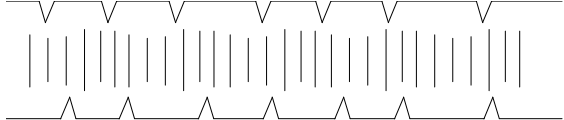
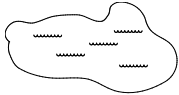
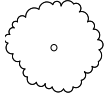
A departmental decision will be made as to type of diagramming method used. An agency may use the Institute of Transportation Engineers (ITE) symbols, template drawings, or drawings produced using computer software. The following is a list of legends and examples of diagramming procedures.

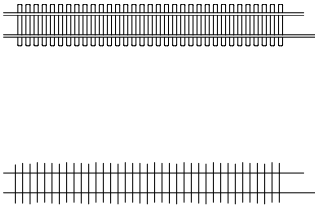
### Template Legend











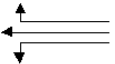

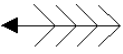
	Passenger Vehicle or Van at Final Rest
	Passenger Vehicle or Van in Motion
	Passenger Vehicle Overturned on Top
	Passenger Vehicle Overturned on Side
	Pickup Truck
	Straight Truck or Dump Truck
	Passenger Bus or Recreational Vehicle
	Cabover Truck Tractor
	Truck Tractor & Trailer Combination with Conventional Tractor Unit
	Box Trailer, House Trailer, or Camper Trailer
	Boat Trailer
	Tanker Trailer
	Locomotive Train Engine
	Farm Tractor

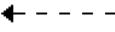



	Motorcycle
	Motorcycle on Side
	Bicycle
	Tricycle
	Body
	Direction Arrow
	Direction of Grade Arrow
	Utility Pole
	Fence
	Guardrail
	Wall Abutment or Concrete Barrier
	Highway Sign
	Electric Signal
	Embankment
	Rock Cut or Bluff Face
	Water Filled Ditch or Canal

	Ditch, Dry or Muddy
	Pond
	Tree
	Bush or Shrub
	Railway Tracks
	Pavement Edge or Curb Line
	Broken Pavement Edge, Gravel or Dirt Road Edge
	Center Line
	Center Line with No Passing Zone
	Shoulder Line
	Skid Mark
	Impact

# ITE Symbol Legend

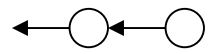
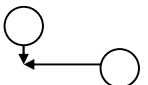
<u>Unit Symbol</u>		<u>Movement Description</u>	
	Vehicle		Moving
	Parked Vehicle		Backing
	Animal		Moving (Not Involved)
	Bicycle		Out of Control
	Fixed Object		Overtake
	Other Object		
	Pedestrian		Indicate Point of Initial Contact
	Train		

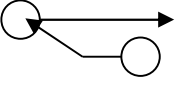
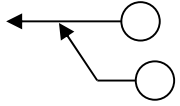
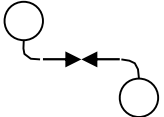
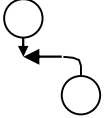
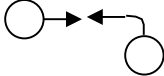
Reflects Initial Impact	Type of Collision	Direction
	Rear End	Same
	Right Angle	Angle
	Head On	Opposite
	Sideswipe	Meeting
	Sideswipe	Passing
	Both Left Turn	Opposite
	Left Turn	Opposite
	Left Turn	Angle Left

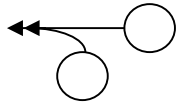
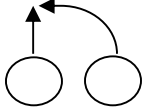
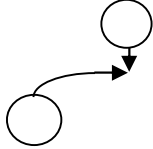
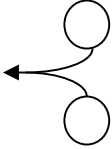
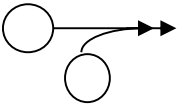
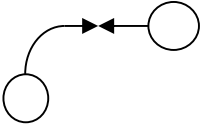
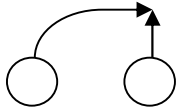
	<b>Left Turn</b>	<b>Angle Right</b>
	<b>Left Turn</b>	<b>Same</b>
	<b>Right Turn</b>	<b>Opposite</b>
	<b>Left Turn / Right Turn</b>	<b>Opposite</b>
	<b>Right Turn</b>	<b>Angle Left</b>
	<b>Right Turn</b>	<b>Angle Right</b>
	<b>Right Turn</b>	<b>Same</b>

# APPENDIX C

## United States, Canada, & Mexico Abbreviations

Enter "XX" for foreign countries not listed below.

UNITED STATES		CANADA	
Alabama	AL	Alberta	AB
Alaska	AK	British Columbia	BC
Arizona	AZ	Manitoba	MB
Arkansas	AR	New Brunswick	NK
California	CA	Newfoundland (includes Labrador)	NF
Colorado	CO	Northwest Territories	NT
Connecticut	CT	Nova Scotia	NS
Delaware	DE	Ontario	ON
District of Columbia	DC	Nunavut	NU
Florida	FL	Prince Edward Island	PE
Georgia	GA	Quebec	PQ
Hawaii	HI	Saskatchewan	SN
Idaho	ID	Yukon (Territory)	YT
Illinois	IL		
Indiana	IN	<b>MEXICO</b>	
Iowa	IA	Aguascalientes	AG
Kansas	KS	Baja California (Northern Section)	BA
Kentucky	KY	Baja California Sur (Southern Section)	BJ
Louisiana	LA	Campeche	CE
Maine	ME	Chiapas	CI
Maryland	MD	Chihuahua	CH
Massachusetts	MA	Coahuila	CU
Michigan	MI	Colima	CL
Minnesota	MN	Distrito Federal (Mexico, D. F.)	DF
Mississippi	MS	Durango	DO
Missouri	MO	Guanajuato	GU
Montana	MT	Guerrero	GR
Nebraska	NB	Hidalgo	HL
Nevada	NV	Jalisco	JL
New Hampshire	NH	Mexico, D.F. (Distrito Federal)	DF
New Jersey	NJ	Mexico (State and Mexico City)	MX
New Mexico	NM	Michoacan	MC
New York	NY	Morelos	MR
North Carolina	NC	Nayarit	NR
North Dakota	ND	Nuevo Leon	NL
Ohio	OH	Oaxaca	OA
Oklahoma	OK	Puebla	PB
Oregon	OR	Queretaro	QU
Pennsylvania	PA	Quintana Roo	QR
Rhode Island	RI	San Luis Potosi	SL
South Carolina	SC	Sinaloa	SI
South Dakota	SD	Sonora	SO
Tennessee	TN	Tabasco	TB
Texas	TX	Tamaulipas	TA
Utah	UT	Tlaxcala	TL
Vermont	VT	Veracruz	VC
Virginia	VA	Yucatan	YU
Washington	WA	Zacatecas	ZA
West Virginia	WV		
Wisconsin	WI	<b>OTHER</b>	
Wyoming	WY	Unknown	UK
		U.S. Government	US

# APPENDIX D

## How to Find the Responsible Carrier and Correct U.S. DOT Number

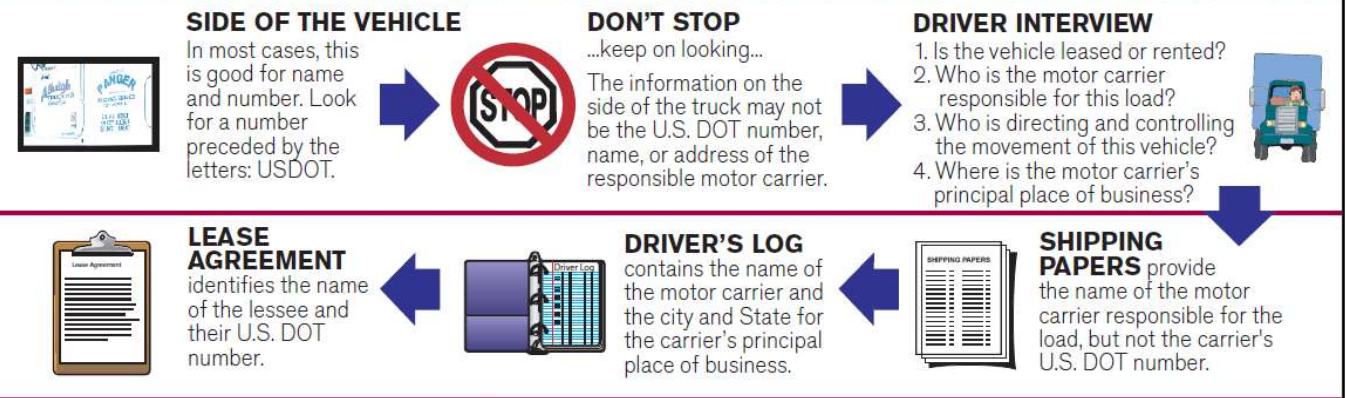

**NOTE: VEHICLE REGISTRATION**  
Generally good for identifying owner or registrant.  
CAREFUL: This may not be the responsible carrier!

**FMCSA WEB SITE:** <http://safer.fmcsa.dot.gov/CompanySnapshot.aspx> is an excellent source for verifying a motor carrier's U.S. DOT number, legal name, "doing business as" name, physical address, and phone number.

Revised 06/05

Federal Motor Carrier  
Safety Administration

U.S. Department of Transportation  
[www.fmcsa.dot.gov](http://www.fmcsa.dot.gov)

## How to Find the Responsible Carrier and Correct U.S. DOT Number

**EXAMPLE 1:** John Smith owns his own truck tractor, operating under John Smith Trucking. He contracts with White Manufacturing to take one of its trailers loaded with its goods from New York to Los Angeles.

**Who is the Motor Carrier:**  
A. John Smith?  
B. White Manufacturing?

John Smith is the motor carrier, because he is the entity that has agreed to carry this particular load.

**EXAMPLE 2:** John Smith, driving his truck tractor, utilizes a cargo broker, K&S Trucking, to obtain goods from Intermodal Inc. shipping company for his return trip back to New York.

**Who is the Motor Carrier:**  
A. John Smith?  
B. K&S Trucking?  
C. Intermodal Inc.?

John Smith is the motor carrier, because K&S transferred the responsibility of the load to John Smith.

**EXAMPLE 3:** John Smith, driving his truck tractor, leases his services to Polyester Chemical Company. Polyester directs Smith to deliver a semi-trailer from New York to St. Louis.

**Who is the Motor Carrier:**  
A. John Smith?  
B. Polyester?

The lease agreement between Polyester and Mr. Smith makes Polyester the motor carrier responsible for the load.

**EXAMPLE 4:** John Smith is driving a tractor/semi-trailer owned and operated by ABC Trucking.

**Who is the Motor Carrier:**  
A. John Smith?  
B. ABC Trucking?

ABC Trucking is the motor carrier. John Smith is just a driver for ABC Trucking.

**EXAMPLE 5:** John Smith is driving a tractor owned by ABC Trucking, which has been leased to XYZ Trucking. XYZ uses the tractor to pull XYZ trailers in its regular shipping service.

**Who is the Motor Carrier:**  
A. John Smith?  
B. ABC Trucking?  
C. XYZ Trucking?

In this case XYZ is the motor carrier, because XYZ is directing the carrying of the load.

Federal Motor Carrier  
Safety Administration

U.S. Department of Transportation  
[www.fmcsa.dot.gov](http://www.fmcsa.dot.gov)

## GUIDELINES FOR IDENTIFYING HAZARDOUS MATERIALS BY SHIPPING PAPERS

### Accessibility:

Shipping papers and emergency response information should be within the driver's reach while he/she is restrained in the lap belt of the vehicle and either readily visible to a person entering the driver's compartment or in a holder which is mounted to the inside of the driver's door.

### Hazardous Material Shipping Paper Description:

The commercial motor vehicle may be transporting more than one hazardous material. The first hazardous material listed on the shipping papers under "Proper Shipping Name" must be shown in [Section 7H - Commercial Motor Vehicle](#). The listing in the shipping papers will look similar to the following example:

Proper Shipping Name	Hazard Class Division	Identification Number	PG	Quantity
Acetone	3	UN1090	II	55 gals
Petroleum Gases, Liquefied	2.1	UN1075		500 lbs

# APPENDIX E

## Classifying and Locating Crashes

The examples below are of fictitious locations, regardless of any similarity to Missouri roadways.

### NON-INTERSECTION CRASHES

Example #1:

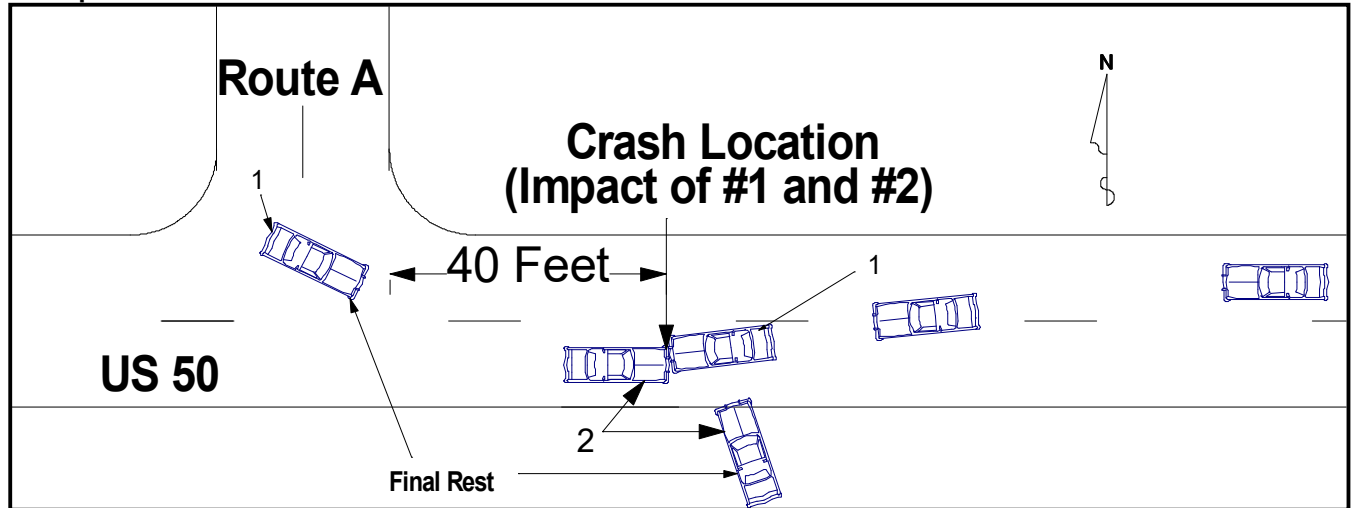

This crash is classified (*Section 1 - Crash Type*) as being a collision "On Roadway" with a "Motor Vehicle in Transport" because the **first harmful event** occurred on the roadway when the two vehicles struck headon. The *Directional Analysis* shows "Front to Front" because the front of one vehicle struck the front of the other.

<b>CRASH TYPE</b>	<b>ROADWAY</b>	<b>NON-COLLISION</b>	<b>COLLISION INVOLVING</b>		<b>DIRECTIONAL ANALYSIS FOR IMPACT WITH MOTOR VEHICLE</b>
	<input checked="" type="checkbox"/> On Roadway <input type="checkbox"/> Off Roadway	<input type="checkbox"/> Overturning <input type="checkbox"/> Fire / Explosion <input type="checkbox"/> Immersion <input type="checkbox"/> Jackknife <input type="checkbox"/> Fell / Jumped From MV	<input type="checkbox"/> Cargo / Equip Loss / Shift <input type="checkbox"/> Other Non-Collision <input type="checkbox"/> Thrown or Falling Object	<input type="checkbox"/> Animal <input type="checkbox"/> Pedalcycle <input type="checkbox"/> Fixed Object <input type="checkbox"/> Other Object	<input type="checkbox"/> Pedestrian <input type="checkbox"/> Struck by Falling, Shifting Cargo or Anything Set in Motion by Motor Vehicle <input type="checkbox"/> Other Object
		<input type="checkbox"/> Railway Vehicle <input checked="" type="checkbox"/> Motor Vehicle in Transport <input type="checkbox"/> Parked Motor Vehicle <input type="checkbox"/> Working Motor Vehicle <input type="checkbox"/> Other Non-Motorist			<input type="checkbox"/> Sideswipe (Same Dir.) <input type="checkbox"/> Sideswipe (Opp. Dir.) <input type="checkbox"/> Other (Explain) <input type="checkbox"/> Unknown (Explain)

This crash is located (*Section 2 - Location*) where the two vehicles struck headon (first harmful event), which is in the eastbound lane of US 50, 40 Feet After RT A. The direction of the intersecting roadway (Int. Dir.) is "N" (northbound lane) because the location of the crash was measured to the northbound lane of Route A.

ON US 50	RDWY. DIR. E	DISTANCE FROM 40 Feet	LOCATION <input checked="" type="checkbox"/> After <input type="checkbox"/> NA <input type="checkbox"/> Before <input type="checkbox"/> At	INTERSECTING RT A
SPEED LIMIT 60	ROADWAY MAINTAINED BY <input checked="" type="checkbox"/> State <input type="checkbox"/> County <input type="checkbox"/> Municipal <input type="checkbox"/> Private Property <input type="checkbox"/> Other			SPEED LIMIT NA
TRAFFICWAY <input type="checkbox"/> One-Way <input checked="" type="checkbox"/> Two-Way, Not Divided <input type="checkbox"/> Two-Way, Divided, Unprotected Median <input type="checkbox"/> Other <input type="checkbox"/> Two-Way, Not Divided, Continuous Center Turn Lane <input type="checkbox"/> Two-Way, Divided, Positive Median Barrier <input type="checkbox"/> Unknown		ROADWAY ALIGNMENT <input checked="" type="checkbox"/> Straight <input type="checkbox"/> Curve <input type="checkbox"/> Unknown (Explain)		ROADWAY PROFILE <input checked="" type="checkbox"/> Level <input type="checkbox"/> Downhill <input type="checkbox"/> Dip <input type="checkbox"/> Uphill <input type="checkbox"/> Hillcrest <input type="checkbox"/> Unknown (Explain)
INTERSECTION TYPE <input checked="" type="checkbox"/> NA <input type="checkbox"/> Cross Intersection (4-Way) <input type="checkbox"/> T-Intersection		ANGLED / SKEWED <input type="checkbox"/> Y-Intersection <input type="checkbox"/> Five or More Legs and Not Circular		ROUNDABOUT / TRAFFIC CIRCLE <input type="checkbox"/> Roundabout <input type="checkbox"/> Other Circular Intersection <input type="checkbox"/> Other (Explain) <input type="checkbox"/> Unknown (Explain)
Enter Codes		ROADWAY CONDITION 1	LIGHT CONDITION 1	WEATHER / ENVIRON CONDITION 1
		ROADWAY SURFACE 1		

The sequence of events (Subsection 7C) for Vehicle #1 is, "Going Straight" (1), "Cross Center of Road" (17) and "Collision with M/V In Transport" (34). The sequence of events for Vehicle #2 is, "Going Straight" (1), "Collision with M/V In Transport" (34), and "Ran Off Roadway - Right" (20).

Vehicle #1:

7C. VEHICLE ACTION / SEQUENCE OF EVENTS CODES			
SEQUENCE OF EVENTS CODES			<input type="checkbox"/> Unknown
1	17	34	

Vehicle #2:

7C. VEHICLE ACTION / SEQUENCE OF EVENTS CODES			
SEQUENCE OF EVENTS CODES			<input type="checkbox"/> Unknown
1	34	20	



**Example #2:**

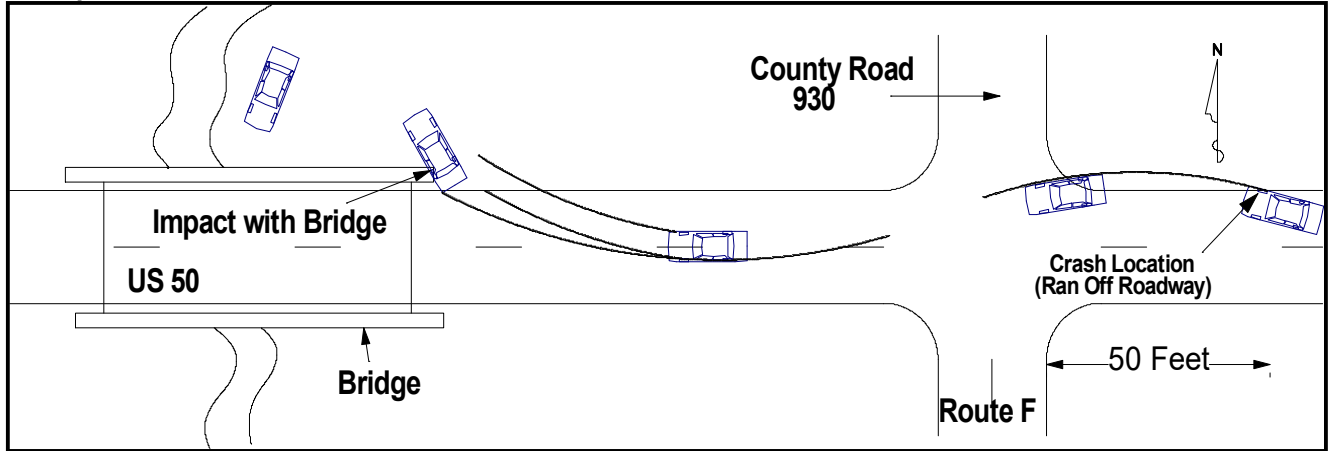

This crash is classified (*Section 1 - Crash Type*) as being a collision "Off Roadway" with a "Fixed Object" because the **first harmful event** was when the vehicle struck the bridge parapet end off the right side of the roadway.

CRASH TYPE	ROADWAY	NON-COLLISION		COLLISION INVOLVING			DIRECTIONAL ANALYSIS FOR IMPACT WITH MOTOR VEHICLE		
	<input type="checkbox"/> On Roadway <input checked="" type="checkbox"/> Off Roadway	<input type="checkbox"/> Overturning <input type="checkbox"/> Fire / Explosion <input type="checkbox"/> Immersion <input type="checkbox"/> Jackknife <input type="checkbox"/> Fell / Jumped From MV	<input type="checkbox"/> Cargo / Equip Loss / Shift <input type="checkbox"/> Other Non-Collision <input type="checkbox"/> Thrown or Falling Object	<input type="checkbox"/> Animal <input type="checkbox"/> Pedalcycle <input checked="" type="checkbox"/> Fixed Object <input type="checkbox"/> Other Object	<input type="checkbox"/> Pedestrian <input type="checkbox"/> Struck by Falling, Shifting Cargo or Anything Set in Motion by Motor Vehicle	<input type="checkbox"/> Railway Vehicle <input type="checkbox"/> Motor Vehicle in Transport <input type="checkbox"/> Parked Motor Vehicle <input type="checkbox"/> Working Motor Vehicle <input type="checkbox"/> Other Non-Motorist	<input type="checkbox"/> Front to Front <input type="checkbox"/> Front to Rear <input type="checkbox"/> Rear to Rear <input type="checkbox"/> Rear to Side <input type="checkbox"/> Angle (Front to Side)	<input type="checkbox"/> Sideswipe (Same Dir.) <input type="checkbox"/> Sideswipe (Opp. Dir.) <input type="checkbox"/> Other (Explain) <input type="checkbox"/> Unknown (Explain)	

This crash is located (*Section 2 - Location*) where the vehicle initially ran off the right side of the roadway, rather than where it struck the bridge. This is true even if the vehicle had struck another vehicle head-on where it crossed the centerline. The crash is shown as occurring on US 50 (Roadway Direction - "W"), 50 Feet Before County Road 930. The direction of the intersecting roadway (Int. Dir.) is "N" (northbound lane) because the location of the crash was measured to the northbound lane of County Road 930.

ON US 50	RDWY. DIR. W	DISTANCE FROM 50 Feet	LOCATION <input type="checkbox"/> After <input type="checkbox"/> NA <input checked="" type="checkbox"/> Before <input type="checkbox"/> At	INTERSECTING CRD 930
SPEED LIMIT 60	ROADWAY MAINTAINED BY <input checked="" type="checkbox"/> State <input type="checkbox"/> County <input type="checkbox"/> Municipal <input type="checkbox"/> Private Property <input type="checkbox"/> Other			SPEED LIMIT NA
TRAFFICWAY <input type="checkbox"/> One-Way <input checked="" type="checkbox"/> Two-Way, Not Divided <input type="checkbox"/> Two-Way, Not Divided, Continuous Center Turn Lane	<input type="checkbox"/> Two-Way, Divided, Unprotected Median <input type="checkbox"/> Two-Way, Divided, Positive Median Barrier <input type="checkbox"/> Other <input type="checkbox"/> Unknown (Explain)	ROADWAY ALIGNMENT <input checked="" type="checkbox"/> Straight <input type="checkbox"/> Curve <input type="checkbox"/> Unknown (Explain)	ROADWAY PROFILE <input checked="" type="checkbox"/> Level <input type="checkbox"/> Downhill <input type="checkbox"/> Dip <input type="checkbox"/> Uphill <input type="checkbox"/> Hillcrest <input type="checkbox"/> Unknown (Explain)	
INTERSECTION TYPE <input checked="" type="checkbox"/> NA <input type="checkbox"/> Cross Intersection (4-Way) <input type="checkbox"/> T-Intersection	ANGLED / SKEWED <input type="checkbox"/> Y-Intersection <input type="checkbox"/> Five or More Legs and Not Circular	ROUNDABOUT / TRAFFIC CIRCLE <input type="checkbox"/> Roundabout <input type="checkbox"/> Other Circular Intersection <input type="checkbox"/> Other (Explain) <input type="checkbox"/> Unknown (Explain)	Enter Codes	ROADWAY CONDITION 2
				ROADWAY SURFACE 1
				LIGHT CONDITION 1
				WEATHER / ENVIRON CONDITION 3

The sequence of events (*Section 7C*) is "Going Straight" (1), "Ran Off Roadway - Right" (20), "Returned to Roadway" (29), "Cross Center of Road" (17), "Ran Off Roadway - Right" (20), and then "Collision Inv. Fixed Object" (36). "Bridge Parapet End" (37) is shown in the "Fixed Object" field.

7C. VEHICLE ACTION / SEQUENCE OF EVENTS CODES		<input type="checkbox"/> Additional Codes Listed in Narrative (See Codes in Section 8)	
SEQUENCE OF EVENTS CODES	<input type="checkbox"/> Unknown	ANIMAL CODE(S)	FIXED OBJECT CODE(S)
1 20 29 17 20 36			37

**Example #3:**

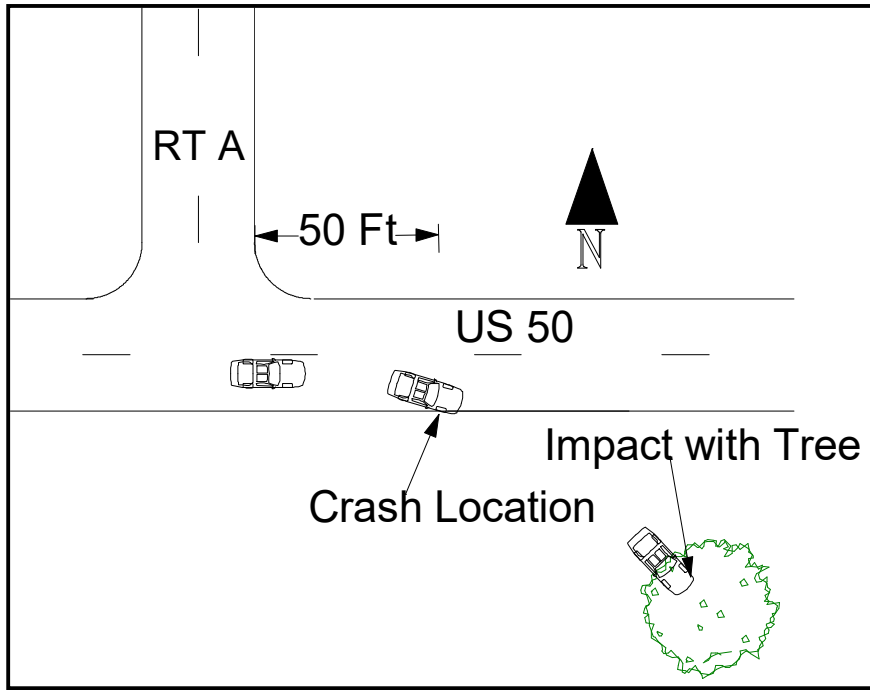

This crash is classified (*Section 1 - Crash Type*) as being a collision "Off Roadway" with a "Fixed Object" because the **first harmful event** was when the vehicle struck the tree off of the roadway.

CRASH TYPE	<input type="checkbox"/> On Roadway	NON-COLLISION		COLLISION INVOLVING			DIRECTIONAL ANALYSIS FOR IMPACT WITH MOTOR VEHICLE			
	<input checked="" type="checkbox"/> Off Roadway	<input type="checkbox"/> Overturning	<input type="checkbox"/> Fire / Explosion	<input type="checkbox"/> Cargo / Equip Loss / Shift	<input type="checkbox"/> Animal	<input type="checkbox"/> Pedestrian	<input type="checkbox"/> Railway Vehicle	<input type="checkbox"/> Motor Vehicle in Transport	<input type="checkbox"/> Front to Front	<input type="checkbox"/> Sideswipe (Same Dir.)
		<input type="checkbox"/> Immersion	<input type="checkbox"/> Jackknife	<input type="checkbox"/> Other Non-Collision	<input type="checkbox"/> Pedalcycle	<input type="checkbox"/> Struck by Falling, Shifting Cargo or Anything Set in Motion by Motor Vehicle	<input type="checkbox"/> Parked Motor Vehicle	<input type="checkbox"/> Working Motor Vehicle	<input type="checkbox"/> Front to Rear	<input type="checkbox"/> Sideswipe (Opp. Dir.)
		<input type="checkbox"/> Fell / Jumped From MV	<input type="checkbox"/> Thrown or Falling Object	<input type="checkbox"/> Other Object			<input type="checkbox"/> Other Non-Motorist	<input type="checkbox"/> Rear to Rear	<input type="checkbox"/> Rear to Side	<input type="checkbox"/> Other (Explain)
								<input type="checkbox"/> Angle (Front to Side)	<input type="checkbox"/> Unknown (Explain)	

The crash is located (*Section 2 - Location*) where the vehicle left the main traveled portion of the roadway. In this case, the location is shown as being on US 50 (Roadway Direction - "E"), 50 Feet After RT A. The direction of the intersecting roadway (Int. Dir.) is "N" (northbound lane) because the location of the crash was measured to the northbound lane of Route A.

ON US 50	RDWY. DIR. E	DISTANCE FROM 50 Feet	LOCATION <input checked="" type="checkbox"/> After <input type="checkbox"/> NA	INTERSECTING RT A
SPEED LIMIT 60	ROADWAY MAINTAINED BY <input checked="" type="checkbox"/> State <input type="checkbox"/> County <input type="checkbox"/> Municipal <input type="checkbox"/> Private Property <input type="checkbox"/> Other	<input type="checkbox"/> NA Miles	<input type="checkbox"/> Before <input type="checkbox"/> At	SPEED LIMIT NA
TRAFFICWAY <input type="checkbox"/> One-Way <input checked="" type="checkbox"/> Two-Way, Not Divided <input type="checkbox"/> Two-Way, Divided, Unprotected Median <input type="checkbox"/> Other	<input type="checkbox"/> Two-Way, Not Divided, Continuous Center Turn Lane <input type="checkbox"/> Two-Way, Divided, Positive Median Barrier <input type="checkbox"/> Unknown	ROADWAY ALIGNMENT <input checked="" type="checkbox"/> Straight <input type="checkbox"/> Curve <input type="checkbox"/> Unknown (Explain)	ROADWAY PROFILE <input checked="" type="checkbox"/> Level <input type="checkbox"/> Downhill <input type="checkbox"/> Dip <input type="checkbox"/> Uphill <input type="checkbox"/> Hillcrest <input type="checkbox"/> Unknown (Explain)	INT. DIR. N
INTERSECTION TYPE <input checked="" type="checkbox"/> NA <input type="checkbox"/> Cross Intersection (4-Way) <input type="checkbox"/> T-Intersection	ANGLED / SKEWED <input type="checkbox"/> Y-Intersection <input type="checkbox"/> Five or More Legs and Not Circular	ROUNDBOUT / TRAFFIC CIRCLE <input type="checkbox"/> Roundabout <input type="checkbox"/> Other Circular Intersection <input type="checkbox"/> Other (Explain) <input type="checkbox"/> Unknown (Explain)	Enter Codes ROADWAY CONDITION 2	GEO - CODE NA
			LIGHT CONDITION 1	ROADWAY SURFACE 1
			WEATHER / ENVIRON CONDITION 3	

The Sequence of Events (*Section 7C*) is "Going Straight" (1), "Ran Off Roadway - Right" (20), and then "Collision Inv. Fixed Object" (36). "Tree / Stump (Standing)" (20) is shown in the "Fixed Object" field.

7C. VEHICLE ACTION / SEQUENCE OF EVENTS CODES				<input type="checkbox"/> Additional Codes Listed in Narrative	(See Codes in Section 8)
SEQUENCE OF EVENTS CODES				<input type="checkbox"/> Unknown	ANIMAL CODE(S)
1	20	36			FIXED OBJECT CODE(S) 20

**Example #4:**

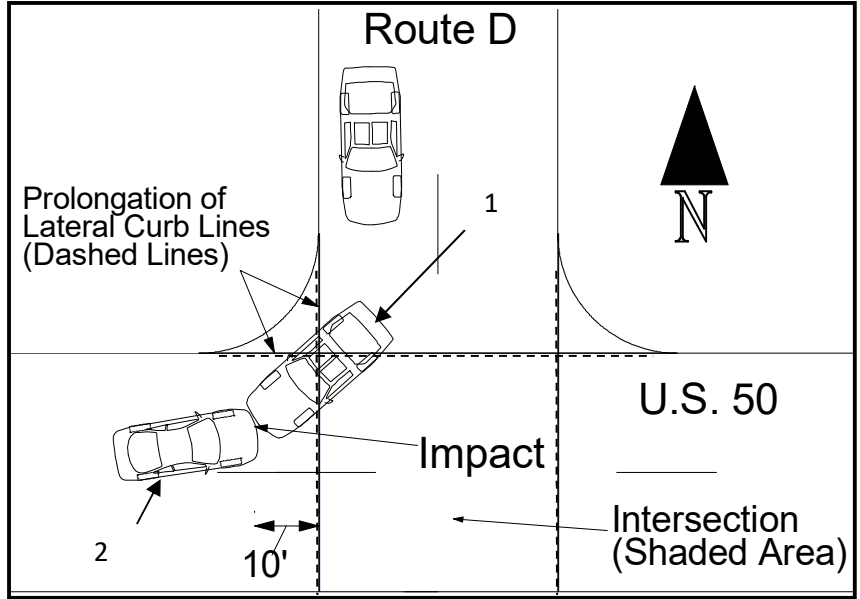

This crash is classified (*Section 1 - Crash Type*) as being a collision "On Roadway" with a "Motor Vehicle in Transport" because the **first harmful event** occurred on the roadway when the two vehicles struck. The *Directional Analysis* shows "Front to Front" because the front of one vehicle struck the front of the other.

CRASH TYPE	ROADWAY	NON-COLLISION		COLLISION INVOLVING			DIRECTIONAL ANALYSIS FOR IMPACT WITH MOTOR VEHICLE		
	<input checked="" type="checkbox"/> On Roadway <input type="checkbox"/> Off Roadway	<input type="checkbox"/> Overturning <input type="checkbox"/> Fire / Explosion <input type="checkbox"/> Immersion <input type="checkbox"/> Jackknife <input type="checkbox"/> Fell / Jumped From MV	<input type="checkbox"/> Cargo / Equip Loss / Shift <input type="checkbox"/> Other Non-Collision <input type="checkbox"/> Thrown or Falling Object	<input type="checkbox"/> Animal <input type="checkbox"/> Pedalcycle <input type="checkbox"/> Fixed Object <input type="checkbox"/> Other Object	<input type="checkbox"/> Pedestrian <input type="checkbox"/> Struck by Falling, Shifting Cargo or Anything Set in Motion by Motor Vehicle <input type="checkbox"/> Other Object	<input type="checkbox"/> Railway Vehicle <input checked="" type="checkbox"/> Motor Vehicle in Transport <input type="checkbox"/> Parked Motor Vehicle <input type="checkbox"/> Working Motor Vehicle <input type="checkbox"/> Other Non-Motorist	<input checked="" type="checkbox"/> Front to Front <input type="checkbox"/> Front to Rear <input type="checkbox"/> Rear to Rear <input type="checkbox"/> Rear to Side <input type="checkbox"/> Angle (Front to Side)	<input type="checkbox"/> Sideswipe (Same Dir.) <input type="checkbox"/> Sideswipe (Opp. Dir.) <input type="checkbox"/> Other (Explain) <input type="checkbox"/> Unknown (Explain)	

The crash is located (*Section 2 - Location*) outside the intersection. The location is shown as being on US 50 (Roadway Direction - "W"), 10 Feet After RT D. The direction of the intersecting roadway (Int. Dir.) is "S" (southbound lane) because the location of the crash was measured to the southbound lane of Route D.

ON US 50	RDWY. DIR. W	DISTANCE FROM 10	LOCATION <input checked="" type="checkbox"/> After <input type="checkbox"/> Before <input type="checkbox"/> At	INTERSECTING RT D
SPEED LIMIT 60	ROADWAY MAINTAINED BY <input checked="" type="checkbox"/> State <input type="checkbox"/> County <input type="checkbox"/> Municipal <input type="checkbox"/> Private Property <input type="checkbox"/> Other	<input type="checkbox"/> NA Feet <input type="checkbox"/> Miles	<input type="checkbox"/> NA	SPEED LIMIT NA
TRAFFICWAY <input type="checkbox"/> One-Way <input type="checkbox"/> Two-Way, Not Divided, Continuous Center Turn Lane	<input checked="" type="checkbox"/> Two-Way, Not Divided <input type="checkbox"/> Two-Way, Divided, Unprotected Median <input type="checkbox"/> Two-Way, Divided, Positive Median Barrier <input type="checkbox"/> Other <input type="checkbox"/> Unknown	ROADWAY ALIGNMENT <input checked="" type="checkbox"/> Straight <input type="checkbox"/> Curve <input type="checkbox"/> Unknown (Explain)	ROADWAY PROFILE <input checked="" type="checkbox"/> Level <input type="checkbox"/> Uphill <input type="checkbox"/> Downhill <input type="checkbox"/> Hillcrest <input type="checkbox"/> Dip <input type="checkbox"/> Unknown (Explain)	INT. DIR. S
INTERSECTION TYPE <input checked="" type="checkbox"/> NA <input type="checkbox"/> Cross Intersection (4-Way) <input type="checkbox"/> T-Intersection	ANGLED / SKEWED <input type="checkbox"/> Y-Intersection <input type="checkbox"/> Five or More Legs and Not Circular	ROUNDABOUT / TRAFFIC CIRCLE <input type="checkbox"/> Roundabout <input type="checkbox"/> Other Circular Intersection <input type="checkbox"/> Other (Explain) <input type="checkbox"/> Unknown (Explain)	Enter Codes ROADWAY CONDITION 1	GEO—CODE NA
			WEATHER / ENVIRON CONDITION 1	ROADWAY SURFACE 1

The sequence of events (*Section 7C*) for Vehicle #1 is (assuming it stopped before turning right) "Start in Traffic" (9), "Making Right Turn" (3), and Collision Inv. MV in Transport" (34). The sequence of events for Vehicle #2 is "Going Straight" (1), "Cross Center of Road" (17) and "Collision Inv. MV in Transport" (34).

Vehicle #1:

7C. VEHICLE ACTION / SEQUENCE OF EVENTS CODES				
SEQUENCE OF EVENTS CODES	<input type="checkbox"/> Unknown			
9	3	34		

Vehicle #2:

7C. VEHICLE ACTION / SEQUENCE OF EVENTS CODES				
SEQUENCE OF EVENTS CODES	<input type="checkbox"/> Unknown			
1	17	34		

In this case, the *Compass Direction* under *Section 6 - Collision Diagram* should reflect vehicle #1 as "S" (south) and vehicle #2 as "E" (east).

**Example #5:**

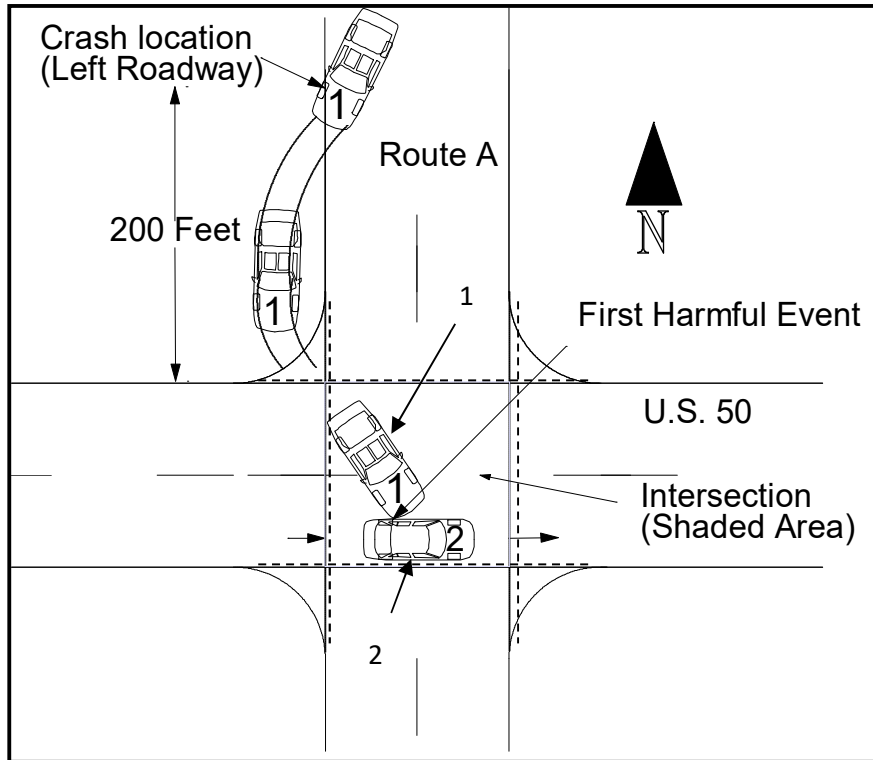

This crash is classified (*Section 1 - Crash Type*) as being a collision "On Roadway" with a "Motor Vehicle in Transport" because the **first harmful event** occurred on the roadway when the two vehicles struck. The *Directional Analysis* shows "Angle" because the front of vehicle #1 struck the side of vehicle #2.

CRASH TYPE	ROADWAY	NON-COLLISION		COLLISION INVOLVING			DIRECTIONAL ANALYSIS FOR IMPACT WITH MOTOR VEHICLE		
	<input checked="" type="checkbox"/> On Roadway <input type="checkbox"/> Off Roadway	<input type="checkbox"/> Overturning <input type="checkbox"/> Fire / Explosion <input type="checkbox"/> Immersion <input type="checkbox"/> Jackknife <input type="checkbox"/> Fell / Jumped From MV	<input type="checkbox"/> Cargo / Equip Loss / Shift <input type="checkbox"/> Other Non-Collision <input type="checkbox"/> Thrown or Falling Object	<input type="checkbox"/> Animal <input type="checkbox"/> Pedalcycle <input type="checkbox"/> Fixed Object <input type="checkbox"/> Other Object	<input type="checkbox"/> Pedestrian <input type="checkbox"/> Struck by Falling, Shifting Cargo or Anything Set in Motion by Motor Vehicle	<input type="checkbox"/> Railway Vehicle <input checked="" type="checkbox"/> Motor Vehicle in Transport <input type="checkbox"/> Parked Motor Vehicle <input type="checkbox"/> Working Motor Vehicle <input type="checkbox"/> Other Non-Motorist	<input type="checkbox"/> Front to Front <input type="checkbox"/> Front to Rear <input type="checkbox"/> Rear to Rear <input type="checkbox"/> Rear to Side <input checked="" type="checkbox"/> Angle (Front to Side)	<input type="checkbox"/> Sideswipe (Same Dir.) <input type="checkbox"/> Sideswipe (Opp. Dir.) <input type="checkbox"/> Other (Explain) <input type="checkbox"/> Unknown (Explain)	

The crash is located (*Section 2 - Location*) outside the intersection where Vehicle #1 first left the roadway (even though the vehicle returned to and the first harmful event was on the roadway). The location is shown as being on RT A (Roadway Direction - "S"), 200 Feet Before US 50. The direction of the intersecting roadway (Int. Dir.) is "W" (westbound lanes) because the location was measured to the westbound lane of US 50.

ON	RDWY. DIR.	DISTANCE FROM	LOCATION	INTERSECTING
RT A	S	200 Feet NA	<input type="checkbox"/> After <input type="checkbox"/> NA <input checked="" type="checkbox"/> Before <input type="checkbox"/> At	US 50
SPEED LIMIT	ROADWAY MAINTAINED BY		SPEED LIMIT	INT. DIR.
55	<input checked="" type="checkbox"/> State <input type="checkbox"/> County <input type="checkbox"/> Municipal <input type="checkbox"/> Private Property <input type="checkbox"/> Other		NA	W
				GEO — CODE
				NA
TRAFFICWAY		ROADWAY ALIGNMENT		ROADWAY PROFILE
<input type="checkbox"/> One-Way <input checked="" type="checkbox"/> Two-Way, Not Divided <input type="checkbox"/> Two-Way, Divided, Unprotected Median <input type="checkbox"/> Other <input type="checkbox"/> Two-Way, Not Divided, Continuous Center Turn Lane <input type="checkbox"/> Two-Way, Divided, Positive Median Barrier <input type="checkbox"/> Unknown		<input checked="" type="checkbox"/> Straight <input type="checkbox"/> Curve <input type="checkbox"/> Unknown (Explain)		<input checked="" type="checkbox"/> Level <input type="checkbox"/> Downhill <input type="checkbox"/> Dip <input type="checkbox"/> Uphill <input type="checkbox"/> Hillcrest <input type="checkbox"/> Unknown (Explain)
INTERSECTION TYPE			Enter Codes	ROADWAY CONDITION
<input checked="" type="checkbox"/> NA <input type="checkbox"/> Cross Intersection (4-Way) <input type="checkbox"/> Y-Intersection <input type="checkbox"/> Roundabout <input type="checkbox"/> Other (Explain) <input type="checkbox"/> T-Intersection <input type="checkbox"/> Five or More Legs and Not Circular <input type="checkbox"/> Other Circular Intersection <input type="checkbox"/> Unknown (Explain)				1
				ROADWAY SURFACE
				1
			LIGHT CONDITION	WEATHER / ENVIRON CONDITION
			1	1

The sequence of events (*Section 7C*) for Vehicle #1 is "Going Straight" (1), "Ran Off Roadway - Right" (20), "Returned to Roadway" (29), and "Collision Inv. MV in Transport" (34). The sequence of events for Vehicle #2 is "Going Straight" (1), and "Collision Inv. MV in Transport" (34).

Vehicle #1:

7C. VEHICLE ACTION / SEQUENCE OF EVENTS CODES				
SEQUENCE OF EVENTS CODES <input type="checkbox"/> Unknown				
1	20	29	34	

Vehicle #2:

7C. VEHICLE ACTION / SEQUENCE OF EVENTS CODES				
SEQUENCE OF EVENTS CODES <input type="checkbox"/> Unknown				
1	34			

**Example #6:**

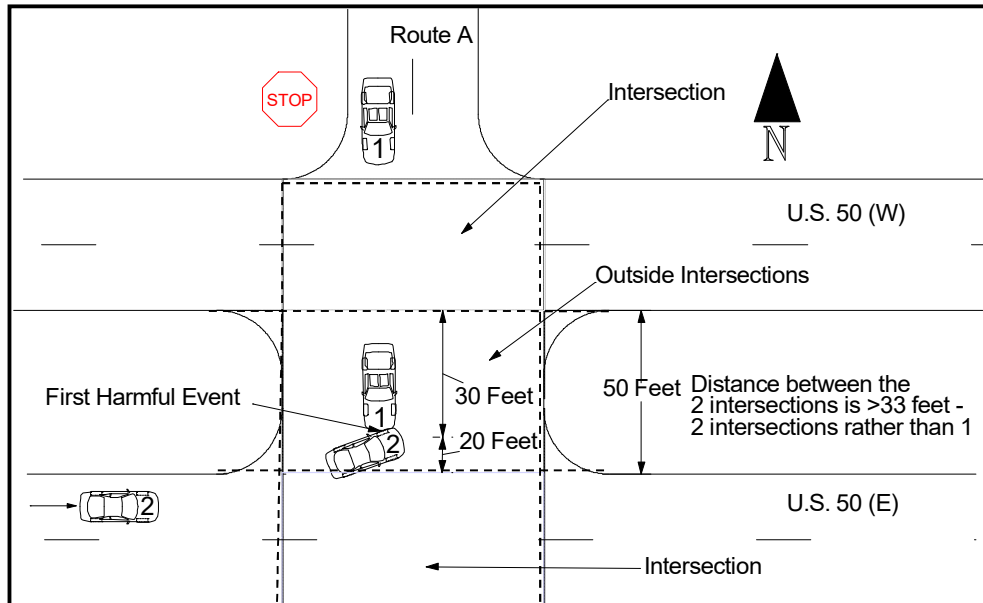

This crash is classified (*Section 1 - Crash Type*) as being a collision "On Roadway" with a "Motor Vehicle in Transport" because the **first harmful event** occurred on the roadway when the two vehicles struck. The *Directional Analysis* shows "Angle" because the front of vehicle #1 struck the side of vehicle #2.

CRASH TYPE	ROADWAY	NON-COLLISION		COLLISION INVOLVING			DIRECTIONAL ANALYSIS FOR IMPACT WITH MOTOR VEHICLE			
	<input checked="" type="checkbox"/> On Roadway <input type="checkbox"/> Off Roadway	<input type="checkbox"/> Overturning <input type="checkbox"/> Fire / Explosion <input type="checkbox"/> Immersion <input type="checkbox"/> Jackknife <input type="checkbox"/> Fell / Jumped From MV	<input type="checkbox"/> Cargo / Equip Loss / Shift <input type="checkbox"/> Other Non-Collision <input type="checkbox"/> Thrown or Falling Object	<input type="checkbox"/> Animal <input type="checkbox"/> Pedalcycle <input type="checkbox"/> Fixed Object <input type="checkbox"/> Other Object	<input type="checkbox"/> Pedestrian <input type="checkbox"/> Struck by Falling, Shifting Cargo or Anything Set in Motion by Motor Vehicle <input type="checkbox"/> Other Object	<input type="checkbox"/> Railway Vehicle <input checked="" type="checkbox"/> Motor Vehicle in Transport <input type="checkbox"/> Parked Motor Vehicle <input type="checkbox"/> Working Motor Vehicle <input type="checkbox"/> Other Non-Motorist	<input type="checkbox"/> Front to Front <input type="checkbox"/> Front to Rear <input type="checkbox"/> Rear to Rear <input type="checkbox"/> Rear to Side <input checked="" type="checkbox"/> Angle (Front to Side)	<input type="checkbox"/> Sideswipe (Same Dir.) <input type="checkbox"/> Sideswipe (Opp. Dir.) <input type="checkbox"/> Other (Explain) <input type="checkbox"/> Unknown (Explain)		

The east and westbound lanes of US 50 are over 33 feet apart at Route A; therefore, there are two intersections. The crash is located (*Section 2 - Location*) outside the two intersections. The location can be shown on the crash report as on Route A and referenced to either east or westbound US 50.

1. On RT A (Roadway Direction - "S"), 30 Feet After US 50. The direction of the intersecting roadway (Int. Dir.) is shown as "W" (westbound lane).

ON	RDWY. DIR.	DISTANCE FROM	LOCATION	INTERSECTING
RT A	S	30 Feet	<input checked="" type="checkbox"/> After <input type="checkbox"/> Before <input type="checkbox"/> At	US 50
SPEED LIMIT	ROADWAY MAINTAINED BY			SPEED LIMIT INT. DIR. GEO - CODE
55	<input checked="" type="checkbox"/> State <input type="checkbox"/> County <input type="checkbox"/> Municipal <input type="checkbox"/> Private Property <input type="checkbox"/> Other			NA W NA
TRAFFICWAY		ROADWAY ALIGNMENT		ROADWAY PROFILE
<input type="checkbox"/> One-Way <input checked="" type="checkbox"/> Two-Way, Not Divided <input type="checkbox"/> Two-Way, Divided, Unprotected Median <input type="checkbox"/> Other <input type="checkbox"/> Two-Way, Not Divided, Continuous Center Turn Lane <input type="checkbox"/> Two-Way, Divided, Positive Median Barrier <input type="checkbox"/> Unknown		<input checked="" type="checkbox"/> Straight <input type="checkbox"/> Curve <input type="checkbox"/> Unknown (Explain)		<input checked="" type="checkbox"/> Level <input type="checkbox"/> Downhill <input type="checkbox"/> Dip <input type="checkbox"/> Uphill <input type="checkbox"/> Hillcrest <input type="checkbox"/> Unknown (Explain)
INTERSECTION TYPE			Enter Codes	ROADWAY CONDITION
<input checked="" type="checkbox"/> NA <input type="checkbox"/> Cross Intersection (4-Way) <input type="checkbox"/> Y-Intersection <input type="checkbox"/> T-Intersection <input type="checkbox"/> Angled / Skewed <input type="checkbox"/> Five or More Legs and Not Circular <input type="checkbox"/> Roundabout <input type="checkbox"/> Other Circular Intersection <input type="checkbox"/> Other (Explain) <input type="checkbox"/> Unknown (Explain)				1
				WEATHER / ENVIRON CONDITION
				1
				ROADWAY SURFACE
				1

2. On RT A (Roadway Direction - "S"), 20 Feet Before US 50. The direction of the intersecting roadway (Int. Dir.) is shown as "E" (eastbound lane).

ON	RDWY. DIR.	DISTANCE FROM	LOCATION	INTERSECTING
RT A	S	20 Feet	<input type="checkbox"/> After <input checked="" type="checkbox"/> Before <input type="checkbox"/> At	US 50
SPEED LIMIT	ROADWAY MAINTAINED BY			SPEED LIMIT INT. DIR. GEO - CODE
55	<input checked="" type="checkbox"/> State <input type="checkbox"/> County <input type="checkbox"/> Municipal <input type="checkbox"/> Private Property <input type="checkbox"/> Other			NA E NA
TRAFFICWAY		ROADWAY ALIGNMENT		ROADWAY PROFILE
<input type="checkbox"/> One-Way <input checked="" type="checkbox"/> Two-Way, Not Divided <input type="checkbox"/> Two-Way, Divided, Unprotected Median <input type="checkbox"/> Other <input type="checkbox"/> Two-Way, Not Divided, Continuous Center Turn Lane <input type="checkbox"/> Two-Way, Divided, Positive Median Barrier <input type="checkbox"/> Unknown		<input checked="" type="checkbox"/> Straight <input type="checkbox"/> Curve <input type="checkbox"/> Unknown (Explain)		<input checked="" type="checkbox"/> Level <input type="checkbox"/> Downhill <input type="checkbox"/> Dip <input type="checkbox"/> Uphill <input type="checkbox"/> Hillcrest <input type="checkbox"/> Unknown (Explain)
INTERSECTION TYPE			Enter Codes	ROADWAY CONDITION
<input checked="" type="checkbox"/> NA <input type="checkbox"/> Cross Intersection (4-Way) <input type="checkbox"/> Y-Intersection <input type="checkbox"/> T-Intersection <input type="checkbox"/> Angled / Skewed <input type="checkbox"/> Five or More Legs and Not Circular <input type="checkbox"/> Roundabout <input type="checkbox"/> Other Circular Intersection <input type="checkbox"/> Other (Explain) <input type="checkbox"/> Unknown (Explain)				1
				WEATHER / ENVIRON CONDITION
				1
				ROADWAY SURFACE
				1

The sequence of events (*Section 7C*) for Vehicle #1 is "Going Straight" (1) and "Collision Inv. MV in Transport" (34). The sequence of events for Vehicle #2 is "Going Straight" (1), "Making Left Turn" (5), and "Collision Inv. MV in Transport" (34).

Vehicle #1:

7C. VEHICLE ACTION / SEQUENCE OF EVENTS CODES									
SEQUENCE OF EVENTS CODES								<input type="checkbox"/> Unknown	
1	34								

Vehicle #2:

7C. VEHICLE ACTION / SEQUENCE OF EVENTS CODES									
SEQUENCE OF EVENTS CODES								<input type="checkbox"/> Unknown	
1	5	34							

In this case, the *Compass Direction* under *Section 6 - Collision Diagram* should reflect vehicle #1 as "S" (south) and vehicle #2 as "E" (east).

**Example #7:**

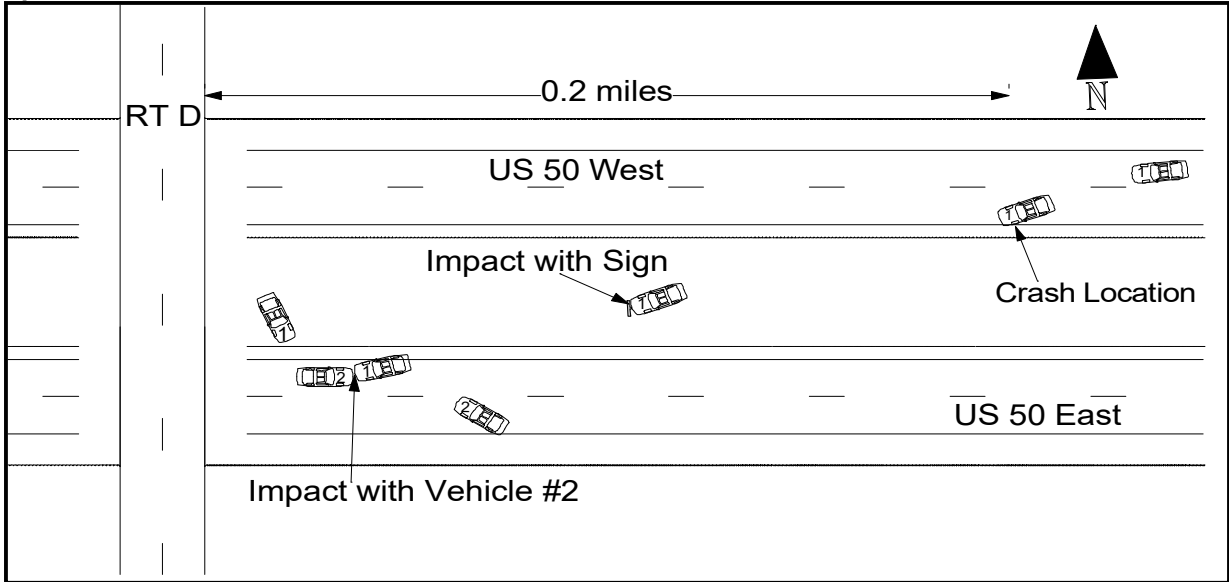

This crash is classified (*Section 1 - Crash Type*) as being a collision "Off Roadway" with a "Fixed Object" because the **first harmful event** was when the westbound vehicle struck the sign in the **median**.

CRASH TYPE	ROADWAY	NON-COLLISION		COLLISION INVOLVING			DIRECTIONAL ANALYSIS FOR IMPACT WITH MOTOR VEHICLE		
	<input type="checkbox"/> On Roadway <input checked="" type="checkbox"/> Off Roadway	<input type="checkbox"/> Overturning <input type="checkbox"/> Fire / Explosion <input type="checkbox"/> Immersion <input type="checkbox"/> Jackknife <input type="checkbox"/> Fell / Jumped From MV	<input type="checkbox"/> Cargo / Equip Loss / Shift <input type="checkbox"/> Other Non-Collision <input type="checkbox"/> Thrown or Falling Object	<input type="checkbox"/> Animal <input type="checkbox"/> Pedalcycle <input checked="" type="checkbox"/> Fixed Object <input type="checkbox"/> Other Object	<input type="checkbox"/> Pedestrian <input type="checkbox"/> Struck by Falling, Shifting Cargo or Anything Set in Motion by Motor Vehicle	<input type="checkbox"/> Railway Vehicle <input type="checkbox"/> Motor Vehicle in Transport <input type="checkbox"/> Parked Motor Vehicle <input type="checkbox"/> Working Motor Vehicle <input type="checkbox"/> Other Non-Motorist	<input type="checkbox"/> Front to Front <input type="checkbox"/> Front to Rear <input type="checkbox"/> Rear to Rear <input type="checkbox"/> Rear to Side <input type="checkbox"/> Angle (Front to Side)	<input type="checkbox"/> Sideswipe (Same Dir.) <input type="checkbox"/> Sideswipe (Opp. Dir.) <input type="checkbox"/> Other (Explain) <input type="checkbox"/> Unknown (Explain)	

Although the first harmful event in this crash was impact of the westbound vehicle with the sign, the crash is located (*Section 2 - Location*) where the vehicle left the westbound roadway. The location is shown as being on US 50 (Roadway Direction - "W"), 0.2 Miles Before RT D. The direction of the intersecting roadway (Int. Dir.) is "N" (northbound lane) because the location of the crash was measured to the northbound lane of Route D.

ON US 50		RDWY. DIR. W	DISTANCE FROM 0.2 Miles	LOCATION <input type="checkbox"/> After <input type="checkbox"/> NA <input checked="" type="checkbox"/> Before <input type="checkbox"/> At	INTERSECTING RT D	
SPEED LIMIT 65	ROADWAY MAINTAINED BY <input checked="" type="checkbox"/> State <input type="checkbox"/> County <input type="checkbox"/> Municipal <input type="checkbox"/> Private Property <input type="checkbox"/> Other		Feet	SPEED LIMIT NA		INT. DIR. N
TRAFFICWAY <input type="checkbox"/> One-Way <input type="checkbox"/> Two-Way, Not Divided <input checked="" type="checkbox"/> Two-Way, Divided; Unprotected Median <input type="checkbox"/> Other <input type="checkbox"/> Two-Way, Not Divided; Continuous Center Turn Lane <input type="checkbox"/> Two-Way, Divided; Positive Median Barrier <input type="checkbox"/> Unknown		ROADWAY ALIGNMENT <input checked="" type="checkbox"/> Straight <input type="checkbox"/> Curve <input type="checkbox"/> Unknown (Explain)		ROADWAY PROFILE <input checked="" type="checkbox"/> Level <input type="checkbox"/> Downhill <input type="checkbox"/> Dip <input type="checkbox"/> Uphill <input type="checkbox"/> Hillcrest <input type="checkbox"/> Unknown (Explain)		
INTERSECTION TYPE <input checked="" type="checkbox"/> NA <input type="checkbox"/> Cross Intersection (4-Way) <input type="checkbox"/> T-Intersection		ANGLED / SKEWED <input type="checkbox"/> Y-Intersection <input type="checkbox"/> Five or More Legs and Not Circular		ROUNDBOUNT / TRAFFIC CIRCLE <input type="checkbox"/> Roundabout <input type="checkbox"/> Other (Explain) <input type="checkbox"/> Other Circular Intersection <input type="checkbox"/> Unknown (Explain)		Enter Codes ROADWAY CONDITION LIGHT CONDITION 1
				ROADWAY SURFACE 1		WEATHER / ENVIRON CONDITION 4 6

The sequence of events (*Section 7C*) for vehicle #1 is "Going Straight" (1), "Ran Off Roadway - Left" (21), "Collision Inv. Fixed Object" (36), "Cross Median" (16), "Collision Inv. MV In Transport" (34) and then "Ran Off Road - Right" (20). "Highway Traffic Sign Post / Support" (27) is shown in the "Fixed Object" field. The sequence of events for vehicle #2 is "Going Straight" (1) and then "Collision Inv. MV In Transport" (34).

**Vehicle #1:**

7C. VEHICLE ACTION / SEQUENCE OF EVENTS CODES		<input type="checkbox"/> Additional Codes Listed in Narrative (See Codes in Section 8)	
SEQUENCE OF EVENTS CODES 1 21 36 16 34 20		ANIMAL CODE(S)	FIXED OBJECT CODE(S) 27

**Vehicle #2:**

7C. VEHICLE ACTION / SEQUENCE OF EVENTS CODES		<input type="checkbox"/> Additional Codes Listed in Narrative (See Codes in Section 8)	
SEQUENCE OF EVENTS CODES 1 34		ANIMAL CODE(S)	FIXED OBJECT CODE(S)

**Example #8:**

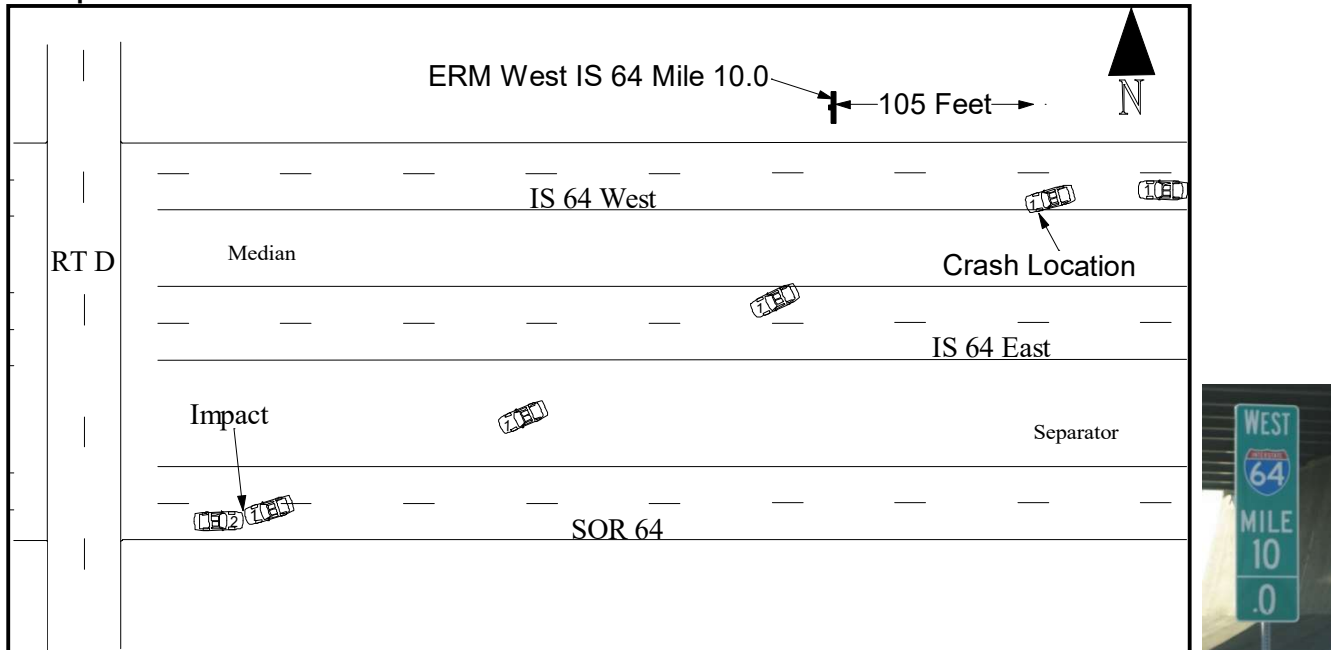

This crash is classified (*Section 1 - Crash Type*) as being a collision "On Roadway" with a "Motor Vehicle In Transport" because the **first harmful event** occurred when the two vehicles struck headon on SOR 64. The *Directional Analysis* shows "Front to Front" because the front of one vehicle struck the front of the other.

CRASH TYPE	ROADWAY	NON-COLLISION		COLLISION INVOLVING			DIRECTIONAL ANALYSIS FOR IMPACT WITH MOTOR VEHICLE		
	<input checked="" type="checkbox"/> On Roadway <input type="checkbox"/> Off Roadway	<input type="checkbox"/> Overturning <input type="checkbox"/> Fire / Explosion <input type="checkbox"/> Immersion <input type="checkbox"/> Jackknife <input type="checkbox"/> Fell / Jumped From MV	<input type="checkbox"/> Cargo / Equip Loss / Shift <input type="checkbox"/> Other Non-Collision <input type="checkbox"/> Thrown or Falling Object	<input type="checkbox"/> Animal <input type="checkbox"/> Pedalcycle <input type="checkbox"/> Fixed Object <input type="checkbox"/> Other Object	<input type="checkbox"/> Pedestrian <input type="checkbox"/> Struck by Falling, Shifting Cargo or Anything Set in Motion by Motor Vehicle <input type="checkbox"/> Railway Vehicle	<input checked="" type="checkbox"/> Motor Vehicle in Transport <input type="checkbox"/> Parked Motor Vehicle <input type="checkbox"/> Working Motor Vehicle <input type="checkbox"/> Other Non-Motorist	<input checked="" type="checkbox"/> Front to Front <input type="checkbox"/> Front to Rear <input type="checkbox"/> Rear to Rear <input type="checkbox"/> Rear to Side <input type="checkbox"/> Angle (Front to Side)	<input type="checkbox"/> Sideswipe (Same Dir.) <input type="checkbox"/> Sideswipe (Opp. Dir.) <input type="checkbox"/> Other (Explain) <input type="checkbox"/> Unknown (Explain)	

The crash is located (*Section 2 - Location*) where the eastbound vehicle first ran off the left side of the roadway. The location is shown as being on IS 64 (Roadway Direction - "W"), 105 Feet Before **ERM** West IS 64 Mile 10.0. "NA" is entered in the intersecting roadway (Int. Dir.) field because the crash location was measured to an **ERM**.

ON IS 64		RDWY, DIR. W	DISTANCE FROM 105 Feet	LOCATION <input type="checkbox"/> After <input checked="" type="checkbox"/> Before <input type="checkbox"/> At	INTERSECTING ERM West IS 64 Mile 10.0		
SPEED LIMIT 70	ROADWAY MAINTAINED BY <input checked="" type="checkbox"/> State <input type="checkbox"/> County <input type="checkbox"/> Municipal <input type="checkbox"/> Private Property <input type="checkbox"/> Other				SPEED LIMIT NA	INT. DIR. NA	GEO—CODE NA
TRAFFICWAY <input type="checkbox"/> One-Way <input type="checkbox"/> Two-Way, Not Divided <input checked="" type="checkbox"/> Two-Way, Divided; Unprotected Median <input type="checkbox"/> Other <input type="checkbox"/> Two-Way, Not Divided; Continuous Center Turn Lane <input type="checkbox"/> Two-Way, Divided; Positive Median Barrier <input type="checkbox"/> Unknown				ROADWAY ALIGNMENT <input checked="" type="checkbox"/> Straight <input type="checkbox"/> Curve <input type="checkbox"/> Unknown (Explain)		ROADWAY PROFILE <input checked="" type="checkbox"/> Level <input type="checkbox"/> Downhill <input type="checkbox"/> Dip <input type="checkbox"/> Uphill <input type="checkbox"/> Hillcrest <input type="checkbox"/> Unknown (Explain)	
INTERSECTION TYPE <input checked="" type="checkbox"/> NA <input type="checkbox"/> Cross Intersection (4-Way) <input type="checkbox"/> T-Intersection				ROUNDABOUT / TRAFFIC CIRCLE <input type="checkbox"/> Roundabout <input type="checkbox"/> Other Circular Intersection <input type="checkbox"/> Other (Explain) <input type="checkbox"/> Unknown (Explain)		Enter Codes	ROADWAY CONDITION 3 4 ROADWAY SURFACE 1
						LIGHT CONDITION 1	WEATHER / ENVIRON CONDITION 4 5 6

The sequence of events (*Section 7C*) for vehicle #1 is "Going Straight" (1), "Ran Off Roadway - Left" (21), "Cross Median" (16), "Cross Road" (18), "Cross Separator" (47), and then "Collision Inv. MV In Transport" (34). The sequence of events for vehicle #2 is "Going Straight" (1), and then "Collision Inv. MV in Transport" (34).

**Vehicle #1:**

7C. VEHICLE ACTION / SEQUENCE OF EVENTS CODES						
SEQUENCE OF EVENTS CODES <input type="checkbox"/> Unknown						
1	21	16	18	47	34	

**Vehicle #2:**

7C. VEHICLE ACTION / SEQUENCE OF EVENTS CODES						
SEQUENCE OF EVENTS CODES <input type="checkbox"/> Unknown						
1	34					



# INTERSECTION CRASHES

## Example #1:

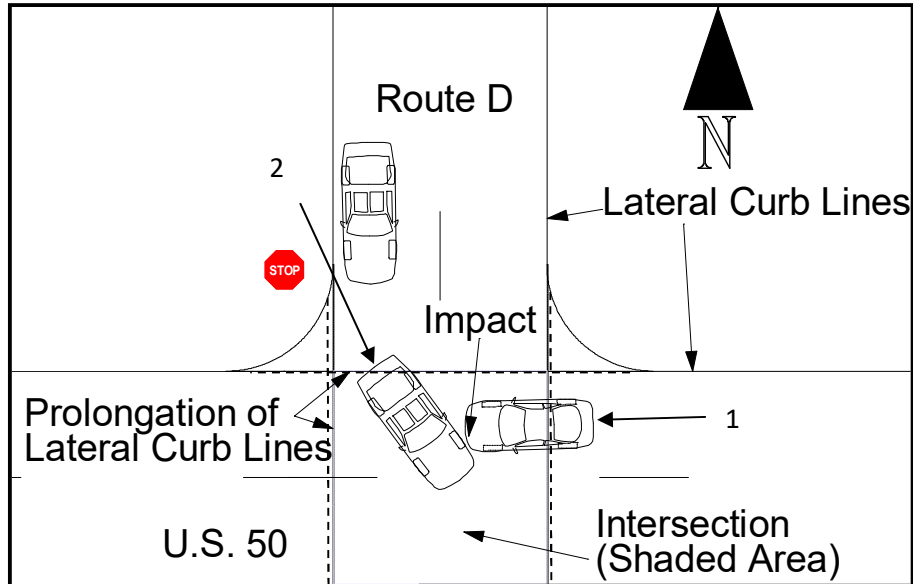

This crash is classified (*Section 1 - Crash Type*) as being a collision "On Roadway" with a "Motor Vehicle in Transport" because the **first harmful event** occurred on the roadway when the two vehicles struck. The *Directional Analysis* shows "Angle" because the front of vehicle #1 struck the side of vehicle #2.

CRASH TYPE	ROADWAY	NON-COLLISION		COLLISION INVOLVING			DIRECTIONAL ANALYSIS FOR IMPACT WITH MOTOR VEHICLE			
	<input checked="" type="checkbox"/> On Roadway <input type="checkbox"/> Off Roadway	<input type="checkbox"/> Overturning <input type="checkbox"/> Fire / Explosion <input type="checkbox"/> Immersion <input type="checkbox"/> Jackknife <input type="checkbox"/> Fell / Jumped From MV	<input type="checkbox"/> Cargo / Equip Loss / Shift <input type="checkbox"/> Other Non-Collision <input type="checkbox"/> Thrown or Falling Object	<input type="checkbox"/> Animal <input type="checkbox"/> Pedalcycle <input type="checkbox"/> Fixed Object <input type="checkbox"/> Other Object	<input type="checkbox"/> Pedestrian <input type="checkbox"/> Struck by Falling, Shifting Cargo or Anything Set in Motion by Motor Vehicle <input type="checkbox"/> Other Object	<input type="checkbox"/> Railway Vehicle <input checked="" type="checkbox"/> Motor Vehicle in Transport <input type="checkbox"/> Parked Motor Vehicle <input type="checkbox"/> Working Motor Vehicle <input type="checkbox"/> Other Non-Motorist	<input type="checkbox"/> Front to Front <input type="checkbox"/> Front to Rear <input type="checkbox"/> Rear to Rear <input type="checkbox"/> Rear to Side <input checked="" type="checkbox"/> Angle (Front to Side)	<input type="checkbox"/> Sideswipe (Same Dir.) <input type="checkbox"/> Sideswipe (Opp. Dir.) <input type="checkbox"/> Other (Explain) <input type="checkbox"/> Unknown (Explain)		

The crash is located (*Section 2 - Location*) within the intersection where the two vehicles struck. The location can be shown on the crash report on either route within the intersection:

1. On US 50 (Roadway Direction - "E" or "W"), At RT D. The direction of the intersecting roadway (Int. Dir.) can be shown as either "N" (northbound lane) or "S" (southbound lane) because the location of the crash was within the intersection of an undivided roadway. Note: Although there are multiple methods for showing the location on US 50, only one example is provided.

ON US 50	RDWY. DIR. E	DISTANCE FROM <input checked="" type="checkbox"/> NA Feet Miles	LOCATION <input type="checkbox"/> After <input type="checkbox"/> NA <input type="checkbox"/> Before <input checked="" type="checkbox"/> At	INTERSECTING RT D	SPEED LIMIT 55	INT. DIR. N	GEO — CODE NA
TRAFFICWAY <input type="checkbox"/> One-Way <input checked="" type="checkbox"/> Two-Way, Not Divided <input type="checkbox"/> Two-Way, Not Divided, Continuous Center Turn Lane		<input type="checkbox"/> Two-Way; Divided, Unprotected Median <input type="checkbox"/> Two-Way; Divided; Positive Median Barrier <input type="checkbox"/> Other <input type="checkbox"/> Unknown		ROADWAY ALIGNMENT <input checked="" type="checkbox"/> Straight <input type="checkbox"/> Curve <input type="checkbox"/> Unknown (Explain)	ROADWAY PROFILE <input checked="" type="checkbox"/> Level <input type="checkbox"/> Downhill <input type="checkbox"/> Dip <input type="checkbox"/> Uphill <input type="checkbox"/> Hillcrest <input type="checkbox"/> Unknown (Explain)		
INTERSECTION TYPE <input type="checkbox"/> NA <input checked="" type="checkbox"/> T-Intersection		PERPENDICULAR <input type="checkbox"/> Cross Intersection (4-Way) <input type="checkbox"/> Y-Intersection <input type="checkbox"/> Five or More Legs and Not Circular		ANGLED / SKEWED <input type="checkbox"/> Y-Intersection <input type="checkbox"/> Five or More Legs and Not Circular		ROUNDABOUT / TRAFFIC CIRCLE <input type="checkbox"/> Roundabout <input type="checkbox"/> Other Circular Intersection <input type="checkbox"/> Other (Explain) <input type="checkbox"/> Unknown (Explain)	
ROADWAY CONDITION 1		LIGHT CONDITION 1		WEATHER / ENVIRON CONDITION 1		ROADWAY SURFACE 1	

2. On RT D (Roadway Direction - "N" or "S"), At US 50. The direction of the intersecting roadway (Int. Dir.) can be shown as either "E" (eastbound lane) or "W" (westbound lane) because the location of the crash was within the intersection of an undivided roadway. Note: Although there are multiple methods for showing the location on RT D, only one example is provided.

ON RTD		RDWY, DIR. S	DISTANCE FROM <input checked="" type="checkbox"/> NA Feet	LOCATION <input type="checkbox"/> After <input type="checkbox"/> NA <input type="checkbox"/> Before <input checked="" type="checkbox"/> At	INTERSECTING US 50								
SPEED LIMIT 55	ROADWAY MAINTAINED BY <input type="checkbox"/> Unknown <input checked="" type="checkbox"/> State <input type="checkbox"/> County <input type="checkbox"/> Municipal <input type="checkbox"/> Private Property <input type="checkbox"/> Other				SPEED LIMIT 60	INT. DIR. W	GEO — CODE NA						
TRAFFICWAY <input type="checkbox"/> One-Way <input checked="" type="checkbox"/> Two-Way, Not Divided <input type="checkbox"/> Two-Way, Divided, Unprotected Median <input type="checkbox"/> Other <input type="checkbox"/> Two-Way, Not Divided, Continuous Center Turn Lane <input type="checkbox"/> Two-Way, Divided, Positive Median Barrier <input type="checkbox"/> Unknown				ROADWAY ALIGNMENT <input checked="" type="checkbox"/> Straight <input type="checkbox"/> Curve <input type="checkbox"/> Unknown (Explain)	ROADWAY PROFILE <input checked="" type="checkbox"/> Level <input type="checkbox"/> Downhill <input type="checkbox"/> Dip <input type="checkbox"/> Uphill <input type="checkbox"/> Hillcrest <input type="checkbox"/> Unknown (Explain)								
INTERSECTION TYPE <input type="checkbox"/> NA <input type="checkbox"/> Cross Intersection (4-Way) <input type="checkbox"/> Y-Intersection <input type="checkbox"/> Five or More Legs and Not Circular				PERPENDICULAR <input checked="" type="checkbox"/> T-Intersection	ANGLED / SKEWED <input type="checkbox"/> Y-Intersection	ROUNDABOUT / TRAFFIC CIRCLE <input type="checkbox"/> Roundabout <input type="checkbox"/> Other Circular Intersection <input type="checkbox"/> Other (Explain) <input type="checkbox"/> Unknown (Explain)	Enter Codes	ROADWAY CONDITION LIGHT CONDITION 1	1	WEATHER / ENVIRON CONDITION	1	ROADWAY SURFACE	1

The sequence of events (*Section 7C*) for Vehicle #1 is "Going Straight" (1) and "Collision Inv. MV in Transport" (34). The sequence of events for Vehicle #2 (assuming it stopped before turning left) is "Start in Traffic" (9), "Making Left Turn" (5), and "Collision Inv. MV in Transport" (34).

Vehicle #1:

7C. VEHICLE ACTION / SEQUENCE OF EVENTS CODES									
SEQUENCE OF EVENTS CODES <input type="checkbox"/> Unknown									
1	34								

Vehicle #2:

7C. VEHICLE ACTION / SEQUENCE OF EVENTS CODES									
SEQUENCE OF EVENTS CODES <input type="checkbox"/> Unknown									
9	5	34							

In this case, the *Compass Direction* under *Section 6 - Collision Diagram* should reflect vehicle #1 as "W" (west) and vehicle #2 as "S" (south).

**Example #2:**

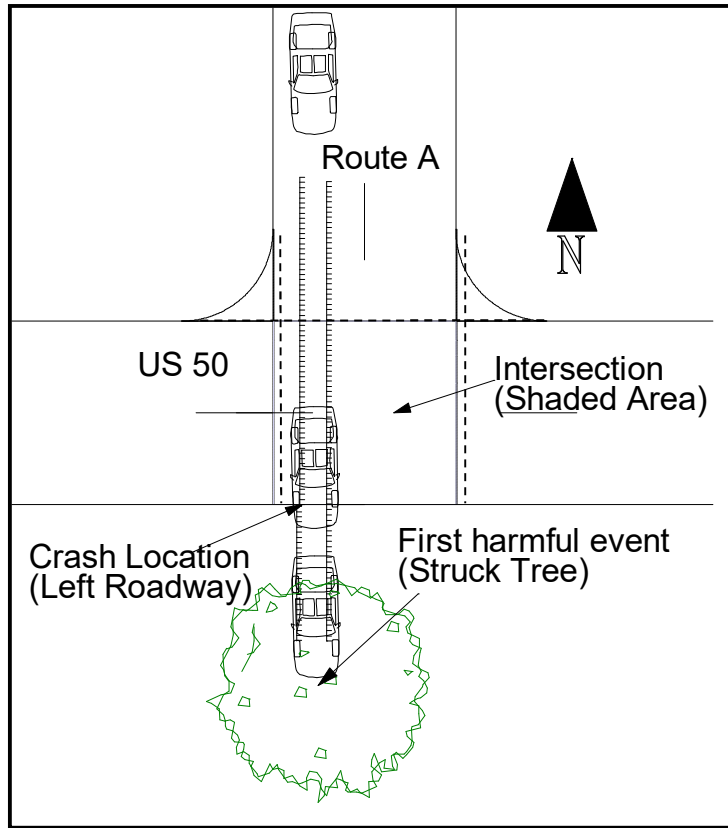

The crash is classified (*Section 1 - Crash Type*) as being a collision "Off Roadway" with a "Fixed Object" because the **first harmful event** occurred when the vehicle struck the tree off the roadway.

CRASH TYPE	ROADWAY	NON-COLLISION		COLLISION INVOLVING			DIRECTIONAL ANALYSIS FOR IMPACT WITH MOTOR VEHICLE	
	<input type="checkbox"/> On Roadway <input checked="" type="checkbox"/> Off Roadway	<input type="checkbox"/> Overturning <input type="checkbox"/> Fire / Explosion <input type="checkbox"/> Immersion <input type="checkbox"/> Jackknife <input type="checkbox"/> Fell / Jumped From MV	<input type="checkbox"/> Cargo / Equip Loss / Shift <input type="checkbox"/> Other <input type="checkbox"/> Non-Collision <input type="checkbox"/> Thrown or Falling Object	<input type="checkbox"/> Animal <input type="checkbox"/> Pedalcycle <input checked="" type="checkbox"/> Fixed Object <input type="checkbox"/> Other Object	<input type="checkbox"/> Pedestrian <input type="checkbox"/> Struck by Falling, Shifting Cargo or Anything Set in Motion by Motor Vehicle	<input type="checkbox"/> Railway Vehicle <input type="checkbox"/> Motor Vehicle in Transport <input type="checkbox"/> Parked Motor Vehicle <input type="checkbox"/> Working Motor Vehicle <input type="checkbox"/> Other Non-Motorist	<input type="checkbox"/> Front to Front <input type="checkbox"/> Front to Rear <input type="checkbox"/> Rear to Rear <input type="checkbox"/> Rear to Side <input type="checkbox"/> Angle (Front to Side)	<input type="checkbox"/> Sideswipe (Same Dir.) <input type="checkbox"/> Sideswipe (Opp. Dir.) <input type="checkbox"/> Other (Explain) <input type="checkbox"/> Unknown (Explain)

The crash is located (*Section 2 - Location*) within the intersection where the vehicle left the roadway. The location can be shown on the crash report on either route within the intersection:

1. On RT A (Roadway Direction - "S") At US 50. The direction of the intersecting roadway (Int. Dir.) can be shown as either "E" (eastbound lane) or "W" (westbound lane) because the location of the crash was within the intersection of an undivided roadway. Note: Although there are two methods for showing the location on RT A, only one example is provided.

ON RT A		RDWY. DIR. S	DISTANCE FROM <input checked="" type="checkbox"/> NA Feet Miles	LOCATION <input type="checkbox"/> After <input type="checkbox"/> NA <input type="checkbox"/> Before <input checked="" type="checkbox"/> At	INTERSECTING US 50	
SPEED LIMIT 55	ROADWAY MAINTAINED BY <input checked="" type="checkbox"/> State <input type="checkbox"/> County <input type="checkbox"/> Municipal <input type="checkbox"/> Private Property <input type="checkbox"/> Other				SPEED LIMIT 60	INT. DIR. E
TRAFFICWAY <input type="checkbox"/> One-Way <input checked="" type="checkbox"/> Two-Way, Not Divided <input type="checkbox"/> Two-Way, Divided, Unprotected Median <input type="checkbox"/> Other <input type="checkbox"/> Two-Way, Not Divided, Continuous Center Turn Lane <input type="checkbox"/> Two-Way, Divided, Positive Median Barrier <input type="checkbox"/> Unknown			ROADWAY ALIGNMENT <input checked="" type="checkbox"/> Straight <input type="checkbox"/> Curve <input type="checkbox"/> Unknown (Explain)		ROADWAY PROFILE <input checked="" type="checkbox"/> Level <input type="checkbox"/> Downhill <input type="checkbox"/> Dip <input type="checkbox"/> Uphill <input type="checkbox"/> Hillcrest <input type="checkbox"/> Unknown (Explain)	
INTERSECTION TYPE <input type="checkbox"/> NA <input checked="" type="checkbox"/> Cross Intersection (4-Way) <input type="checkbox"/> Y-Intersection <input checked="" type="checkbox"/> T-Intersection		ANGLED / SKEWED <input type="checkbox"/> Five or More Legs and Not Circular		ROUNDBOUNT / TRAFFIC CIRCLE <input type="checkbox"/> Roundabout <input type="checkbox"/> Other (Explain) <input type="checkbox"/> Other Circular Intersection <input type="checkbox"/> Unknown (Explain)		Enter Codes ROADWAY CONDITION LIGHT CONDITION
				1		ROADWAY SURFACE 1
				1		WEATHER / ENVIRON. CONDITION 1

2. On US 50 (Roadway Direction "E" or "W") At RT A. The direction of the intersecting roadway (Int. Dir.) can be shown as either "S" (southbound lane) or "N" (northbound lane) because the location of the crash

was within the intersection of an undivided roadway. Note: Although there are two methods for showing the location on US 50, only one example is provided.

ON US 50		RDWY. DIR. E	DISTANCE FROM <input checked="" type="checkbox"/> NA Feet Miles	LOCATION <input type="checkbox"/> After <input type="checkbox"/> NA <input type="checkbox"/> Before <input checked="" type="checkbox"/> At	INTERSECTING RT A		
SPEED LIMIT 60	ROADWAY MAINTAINED BY <input type="checkbox"/> Unknown <input checked="" type="checkbox"/> State <input type="checkbox"/> County <input type="checkbox"/> Municipal <input type="checkbox"/> Private Property <input type="checkbox"/> Other			SPEED LIMIT 55		INT. DIR. S	GEO — CODE NA
TRAFFICWAY <input type="checkbox"/> One-Way <input checked="" type="checkbox"/> Two-Way; Not Divided <input type="checkbox"/> Two-Way; Divided; Unprotected Median <input type="checkbox"/> Other <input type="checkbox"/> Two-Way; Not Divided, Continuous Center Turn Lane <input type="checkbox"/> Two-Way; Divided; Positive Median Barrier <input type="checkbox"/> Unknown			ROADWAY ALIGNMENT <input checked="" type="checkbox"/> Straight <input type="checkbox"/> Curve <input type="checkbox"/> Unknown (Explain)		ROADWAY PROFILE <input checked="" type="checkbox"/> Level <input type="checkbox"/> Downhill <input type="checkbox"/> Dip <input type="checkbox"/> Uphill <input type="checkbox"/> Hillcrest <input type="checkbox"/> Unknown (Explain)		
INTERSECTION TYPE PERPENDICULAR ANGLLED / SKEWED ROUNDABOUT / TRAFFIC CIRCLE <input type="checkbox"/> NA <input type="checkbox"/> Cross Intersection (4-Way) <input type="checkbox"/> Y-Intersection <input type="checkbox"/> Roundabout <input type="checkbox"/> Other (Explain) <input checked="" type="checkbox"/> T-Intersection <input type="checkbox"/> Five or More Legs and Not Circular <input type="checkbox"/> Other Circular Intersection <input type="checkbox"/> Unknown (Explain)			Enter Codes		ROADWAY CONDITION LIGHT CONDITION 1	WEATHER / ENVIRON CONDITION 1	ROADWAY SURFACE 1

The sequence of events (Section 7C) for the vehicle is "Going Straight" (1), "Skidding / Sliding" (7), "End Departure" (50), and "Collision Inv. Fixed Object" (36). "Tree / Stump (Standing)" (20) is shown in the "Fixed Object" field.

7C. VEHICLE ACTION / SEQUENCE OF EVENTS CODES <input type="checkbox"/> Additional Codes Listed in Narrative (See Codes in Section 8)						
SEQUENCE OF EVENTS CODES <input type="checkbox"/> Unknown						
1	7	50	36		ANIMAL CODE(S) 20	FIXED OBJECT CODE(S)
ALCOHOL USE <input type="checkbox"/> Yes <input type="checkbox"/> No <input type="checkbox"/> Unknown <input type="checkbox"/> NA			MARIJUANA USE <input type="checkbox"/> Yes <input type="checkbox"/> No <input type="checkbox"/> Unknown <input type="checkbox"/> NA			

**Example #3:**

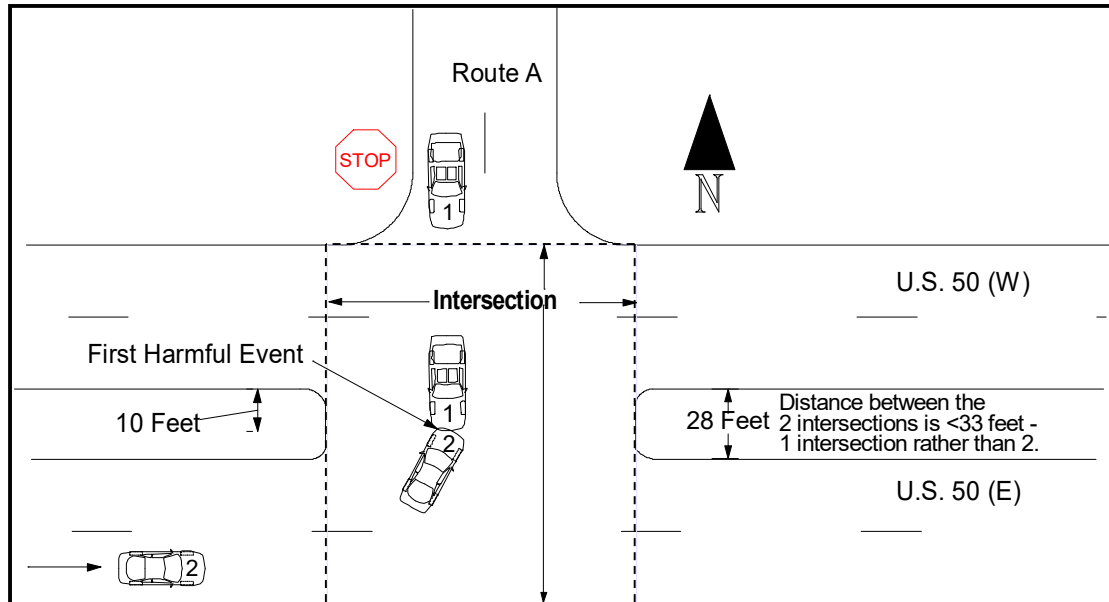

This crash is classified (*Section 1 - Crash Type*) as being a collision "On Roadway" with a "Motor Vehicle in Transport" because the **first harmful event** occurred on the roadway when the two vehicles struck. The *Directional Analysis* shows "Front-to-Front" because the front of vehicle #1 struck the front of vehicle #2.

CRASH TYPE	ROADWAY	NON-COLLISION			COLLISION INVOLVING			DIRECTIONAL ANALYSIS FOR IMPACT WITH MOTOR VEHICLE		
	<input checked="" type="checkbox"/> On Roadway <input type="checkbox"/> Off Roadway	<input type="checkbox"/> Overturning <input type="checkbox"/> Fire / Explosion <input type="checkbox"/> Immersion <input type="checkbox"/> Jackknife <input type="checkbox"/> Fell / Jumped From MV	<input type="checkbox"/> Cargo / Equip Loss / Shift <input type="checkbox"/> Other <input type="checkbox"/> Non-Collision <input type="checkbox"/> Thrown or Falling Object	<input type="checkbox"/> Animal <input type="checkbox"/> Pedalcycle <input type="checkbox"/> Fixed Object <input type="checkbox"/> Other Object	<input type="checkbox"/> Pedestrian <input type="checkbox"/> Struck by Falling, Shifting Cargo or Anything Set in Motion by Motor Vehicle <input type="checkbox"/> Other Object	<input type="checkbox"/> Railway Vehicle <input checked="" type="checkbox"/> Motor Vehicle in Transport <input type="checkbox"/> Parked Motor Vehicle <input type="checkbox"/> Working Motor Vehicle <input type="checkbox"/> Other Non-Motorist	<input checked="" type="checkbox"/> Front to Front <input type="checkbox"/> Front to Rear <input type="checkbox"/> Rear to Rear <input type="checkbox"/> Rear to Side <input type="checkbox"/> Angle (Front to Side)	<input type="checkbox"/> Sideswipe (Same Dir.) <input type="checkbox"/> Sideswipe (Opp. Dir.) <input type="checkbox"/> Other (Explain) <input type="checkbox"/> Unknown (Explain)		

The crash is located (*Section 2 - Location*) within the intersection where the two vehicles struck. The location can be shown on the crash report on either route within the intersection:

1. On US 50 (Roadway Direction - "E" or "W"), At RT A. The direction of the intersecting roadway (Int. Dir.) can be shown as either "N" (northbound lane) or "S" (southbound lane) because the location of the crash was within the intersection of a divided roadway with less than 33 feet distance between the lanes. Note: Although there are multiple methods for showing the location on US 50, only one example is provided.

ON US 50		RDWY. DIR. E	DISTANCE FROM <input checked="" type="checkbox"/> NA Feet Miles	LOCATION <input type="checkbox"/> After <input type="checkbox"/> NA <input type="checkbox"/> Before <input checked="" type="checkbox"/> At	INTERSECTING RT A			
SPEED LIMIT 65	ROADWAY MAINTAINED BY <input checked="" type="checkbox"/> State <input type="checkbox"/> County <input type="checkbox"/> Municipal <input type="checkbox"/> Private Property <input type="checkbox"/> Other				SPEED LIMIT 55	INT. DIR. S	GEO - CODE NA	
TRAFFICWAY <input type="checkbox"/> One-Way <input type="checkbox"/> Two-Way, Not Divided <input checked="" type="checkbox"/> Two-Way, Divided; Unprotected Median <input type="checkbox"/> Other <input type="checkbox"/> Two-Way, Not Divided; Continuous Center Turn Lane <input type="checkbox"/> Two-Way, Divided; Positive Median Barrier <input type="checkbox"/> Unknown				ROADWAY ALIGNMENT <input checked="" type="checkbox"/> Straight <input type="checkbox"/> Curve <input type="checkbox"/> Unknown (Explain)	ROADWAY PROFILE <input checked="" type="checkbox"/> Level <input type="checkbox"/> Downhill <input type="checkbox"/> Dip <input type="checkbox"/> Uphill <input type="checkbox"/> Hillcrest <input type="checkbox"/> Unknown (Explain)			
INTERSECTION TYPE <input type="checkbox"/> NA <input type="checkbox"/> Cross Intersection (4-Way) <input checked="" type="checkbox"/> T-Intersection		ANGLED / SKEWED <input type="checkbox"/> Y-Intersection <input type="checkbox"/> Five or More Legs and Not Circular		ROUNDBOUNT / TRAFFIC CIRCLE <input type="checkbox"/> Roundabout <input type="checkbox"/> Other Circular Intersection <input type="checkbox"/> Other (Explain) <input type="checkbox"/> Unknown (Explain)		Enter Codes	ROADWAY CONDITION 4	ROADWAY SURFACE 1
LIGHT CONDITION 1		WEATHER / ENVIRON CONDITION 3   6						

2. On RT A (Roadway Direction - "N" or "S"), At US 50. The direction of the intersecting roadway (Int. Dir.) can be shown as either "E" (eastbound lane) or "W" (westbound lane) because the location of the crash was within the intersection of a divided roadway with less than 33 feet distance between the lanes. Note: Although there are multiple methods for showing the location on RT A, only one example is provided.

ON RT A		RDWY. DIR. S	DISTANCE FROM <input checked="" type="checkbox"/> NA Feet Miles	LOCATION <input type="checkbox"/> After <input type="checkbox"/> NA <input type="checkbox"/> Before <input checked="" type="checkbox"/> At	INTERSECTING US 50		
SPEED LIMIT 55	ROADWAY MAINTAINED BY <input type="checkbox"/> Unknown <input checked="" type="checkbox"/> State <input type="checkbox"/> County <input type="checkbox"/> Municipal <input type="checkbox"/> Private Property <input type="checkbox"/> Other			SPEED LIMIT 65		INT. DIR. E	GEO — CODE NA
TRAFFICWAY <input type="checkbox"/> One-Way <input checked="" type="checkbox"/> Two-Way; Not Divided <input type="checkbox"/> Two-Way; Divided; Unprotected Median <input type="checkbox"/> Other <input type="checkbox"/> Two-Way; Not Divided; Continuous Center Turn Lane <input type="checkbox"/> Two-Way; Divided; Positive Median Barrier <input type="checkbox"/> Unknown				ROADWAY ALIGNMENT <input checked="" type="checkbox"/> Straight <input type="checkbox"/> Curve <input type="checkbox"/> Unknown (Explain)		ROADWAY PROFILE <input checked="" type="checkbox"/> Level <input type="checkbox"/> Downhill <input type="checkbox"/> Dip <input type="checkbox"/> Uphill <input type="checkbox"/> Hillcrest <input type="checkbox"/> Unknown (Explain)	
INTERSECTION TYPE PERPENDICULAR ANGLD / SKEWED ROUNDABOUT / TRAFFIC CIRCLE <input type="checkbox"/> NA <input type="checkbox"/> Cross Intersection (4-Way) <input type="checkbox"/> Y-Intersection <input type="checkbox"/> Roundabout <input type="checkbox"/> Other (Explain) <input checked="" type="checkbox"/> T-Intersection <input type="checkbox"/> Five or More Legs and Not Circular <input type="checkbox"/> Other Circular Intersection <input type="checkbox"/> Unknown (Explain)				Enter Codes	ROADWAY CONDITION 4	ROADWAY SURFACE 1	
				LIGHT CONDITION 1	WEATHER / ENVIRON CONDITION 3 6		

The sequence of events (*Section 7C*) for Vehicle #1 is "Going Straight" (1) and "Collision Inv. MV in Transport" (34). The sequence of events for Vehicle #2 is "Going Straight" (1), "Making Left Turn" (5), and "Collision Inv. MV in Transport" (34).

Vehicle #1:

7C. VEHICLE ACTION / SEQUENCE OF EVENTS CODES									
SEQUENCE OF EVENTS CODES <input type="checkbox"/> Unknown									
1	34								

Vehicle #2:

7C. VEHICLE ACTION / SEQUENCE OF EVENTS CODES									
SEQUENCE OF EVENTS CODES <input type="checkbox"/> Unknown									
1	5	34							

In this case, the *Compass Direction* under *Section 6 - Collision Diagram* should reflect vehicle #1 as "S" (south) and vehicle #2 as "E" (east).

**Example #4:**

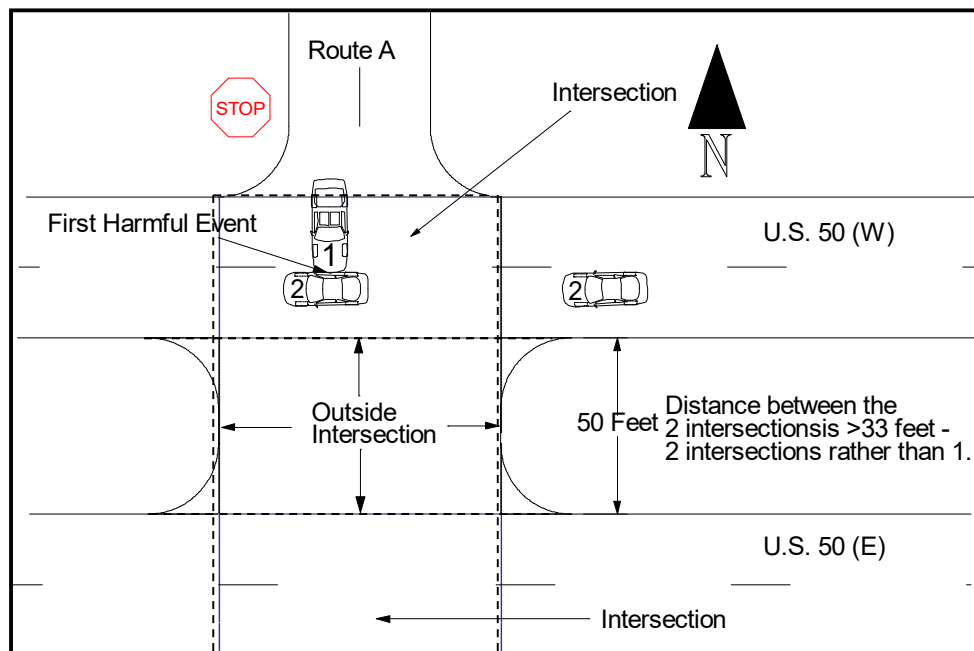

This crash is classified (*Section 1 - Crash Type*) as being a collision "On Roadway" with a "Motor Vehicle in Transport" because the **first harmful event** occurred on the roadway when the two vehicles struck. The *Directional Analysis* shows "Angle" because the front of vehicle #1 struck the side of vehicle #2.

CRASH TYPE	ROADWAY	NON-COLLISION	COLLISION INVOLVING		DIRECTIONAL ANALYSIS FOR IMPACT WITH MOTOR VEHICLE	
	<input checked="" type="checkbox"/> On Roadway <input type="checkbox"/> Off Roadway	<input type="checkbox"/> Overturning <input type="checkbox"/> Fire / Explosion <input type="checkbox"/> Immersion <input type="checkbox"/> Jackknife <input type="checkbox"/> Fell / Jumped From MV	<input type="checkbox"/> Cargo / Equip Loss / Shift <input type="checkbox"/> Other Non-Collision <input type="checkbox"/> Thrown or Falling Object	<input type="checkbox"/> Animal <input type="checkbox"/> Pedalcycle <input type="checkbox"/> Fixed Object <input type="checkbox"/> Other Object	<input type="checkbox"/> Pedestrian <input type="checkbox"/> Struck by Falling, Shifting Cargo or Anything Set in Motion by Motor Vehicle <input type="checkbox"/> Railway Vehicle <input checked="" type="checkbox"/> Motor Vehicle in Transport <input type="checkbox"/> Parked Motor Vehicle <input type="checkbox"/> Working Motor Vehicle <input type="checkbox"/> Other Non-Motorist	<input type="checkbox"/> Front to Front <input type="checkbox"/> Front to Rear <input type="checkbox"/> Rear to Rear <input type="checkbox"/> Rear to Side <input checked="" type="checkbox"/> Angle (Front to Side) <input type="checkbox"/> Sideswipe (Same Dir.) <input type="checkbox"/> Sideswipe (Opp. Dir.) <input type="checkbox"/> Other (Explain) <input type="checkbox"/> Unknown (Explain)

The east and westbound lanes of US 50 are over 33 feet apart at Route A; therefore, there are two intersections. The crash is located (*Section 2 - Location*) within the intersection where the two vehicles struck. The location can be shown on the crash report on either Route A or westbound US 50:

1. On US 50 (Roadway Direction - "W"), At RT A. The direction of the intersecting roadway (Int. Dir.) is shown as either "N" (northbound lane) or "S" (southbound lane) because the crash was within the intersection. Note: Although there are two methods for showing the location on US 50, only one example is provided.

ON US 50	RDWY. DIR. W	DISTANCE FROM <input checked="" type="checkbox"/> NA Feet Miles	LOCATION <input type="checkbox"/> After <input type="checkbox"/> NA <input type="checkbox"/> Before <input checked="" type="checkbox"/> At	INTERSECTING RT A
SPEED LIMIT 65	ROADWAY MAINTAINED BY <input checked="" type="checkbox"/> State <input type="checkbox"/> County <input type="checkbox"/> Municipal <input type="checkbox"/> Private Property <input type="checkbox"/> Other			SPEED LIMIT 55
TRAFFICWAY <input type="checkbox"/> One-Way <input type="checkbox"/> Two-Way, Not Divided <input type="checkbox"/> Two-Way, Not Divided, Continuous Center Turn Lane	<input type="checkbox"/> Two-Way, Not Divided <input checked="" type="checkbox"/> Two-Way, Divided, Unprotected Median <input type="checkbox"/> Two-Way, Divided, Positive Median Barrier <input type="checkbox"/> Other <input type="checkbox"/> Unknown	ROADWAY ALIGNMENT <input checked="" type="checkbox"/> Straight <input type="checkbox"/> Curve <input type="checkbox"/> Unknown (Explain)	ROADWAY PROFILE <input checked="" type="checkbox"/> Level <input type="checkbox"/> Uphill <input type="checkbox"/> Downhill <input type="checkbox"/> Hillcrest <input type="checkbox"/> Dip <input type="checkbox"/> Unknown (Explain)	INT. DIR. S
INTERSECTION TYPE <input type="checkbox"/> NA	PERPENDICULAR <input checked="" type="checkbox"/> Cross Intersection (4-Way) <input type="checkbox"/> T-Intersection	ANGLED / SKEWED <input type="checkbox"/> Y-Intersection <input type="checkbox"/> Five or More Legs and Not Circular	ROUNDABOUT / TRAFFIC CIRCLE <input type="checkbox"/> Roundabout <input type="checkbox"/> Other Circular Intersection <input type="checkbox"/> Other (Explain) <input type="checkbox"/> Unknown (Explain)	Enter Codes LIGHT CONDITION 4 WEATHER / ENVIRON CONDITION 1
				ROADWAY SURFACE 3   6   1

2. On RT A (Roadway Direction - "S"), At US 50. The direction of the intersecting roadway (Int. Dir.) is shown as "W" (westbound lane) because the location of the crash was within the US 50 westbound intersection. Note: The "Roadway Direction" for RT A can be shown as either "N" or "S" because it is within the intersection.

ON RT A		RDWY. DIR. S	DISTANCE FROM <input checked="" type="checkbox"/> NA Feet Miles	LOCATION <input type="checkbox"/> After <input type="checkbox"/> NA <input type="checkbox"/> Before <input checked="" type="checkbox"/> At	INTERSECTING US 50				
SPEED LIMIT 55	ROADWAY MAINTAINED BY <input checked="" type="checkbox"/> State <input type="checkbox"/> County <input type="checkbox"/> Municipal <input type="checkbox"/> Private Property <input type="checkbox"/> Other				SPEED LIMIT 65	INT. DIR. W	GEO — CODE NA		
TRAFFICWAY <input type="checkbox"/> One-Way <input checked="" type="checkbox"/> Two-Way, Not Divided <input type="checkbox"/> Two-Way, Divided, Unprotected Median <input type="checkbox"/> Other <input type="checkbox"/> Two-Way, Not Divided, Continuous Center Turn Lane <input type="checkbox"/> Two-Way, Divided, Positive Median Barrier <input type="checkbox"/> Unknown			ROADWAY ALIGNMENT <input checked="" type="checkbox"/> Straight <input type="checkbox"/> Curve <input type="checkbox"/> Unknown (Explain)		ROADWAY PROFILE <input checked="" type="checkbox"/> Level <input type="checkbox"/> Downhill <input type="checkbox"/> Dip <input type="checkbox"/> Uphill <input type="checkbox"/> Hillcrest <input type="checkbox"/> Unknown (Explain)				
INTERSECTION TYPE PERPENDICULAR <input type="checkbox"/> NA <input checked="" type="checkbox"/> Cross Intersection (4-Way) <input type="checkbox"/> T-Intersection		ANGLED / SKEWED <input type="checkbox"/> Y-Intersection <input type="checkbox"/> Five or More Legs and Not Circular		ROUNDBABOUT / TRAFFIC CIRCLE <input type="checkbox"/> Roundabout <input type="checkbox"/> Other (Explain) <input type="checkbox"/> Other Circular Intersection <input type="checkbox"/> Unknown (Explain)		Enter Codes	ROADWAY CONDITION 4 LIGHT CONDITION 1	WEATHER / ENVIRON CONDITION 3 6	ROADWAY SURFACE 1

The sequence of events (*Section 7C*) for Vehicle #1 is "Start in Traffic" (9), and "Collision Inv. MV in Transport" (34). The sequence of events for Vehicle #2 is "Going Straight" (1) and "Collision Inv. MV in Transport" (34).

Vehicle #1:

7C. VEHICLE ACTION / SEQUENCE OF EVENTS CODES									
SEQUENCE OF EVENTS CODES <input type="checkbox"/> Unknown									
9	34								

Vehicle #2:

7C. VEHICLE ACTION / SEQUENCE OF EVENTS CODES									
SEQUENCE OF EVENTS CODES <input type="checkbox"/> Unknown									
1	34								

In this case, the *Compass Direction* under *Section 6 - Collision Diagram* should reflect vehicle #1 as "S" (south) and vehicle #2 as "W" (west).



## ROUNDBABOUTS / TRAFFIC CIRCLES / CONNECTORS

Crashes occurring within the circle of a roundabout or traffic circle are shown as being "At" the intersection. Crashes occurring on one of the approaching or diverging lanes should be measured to the roundabout circle and then shown "Before" or "After" the intersecting roadway (whichever is appropriate).

### Example #1:

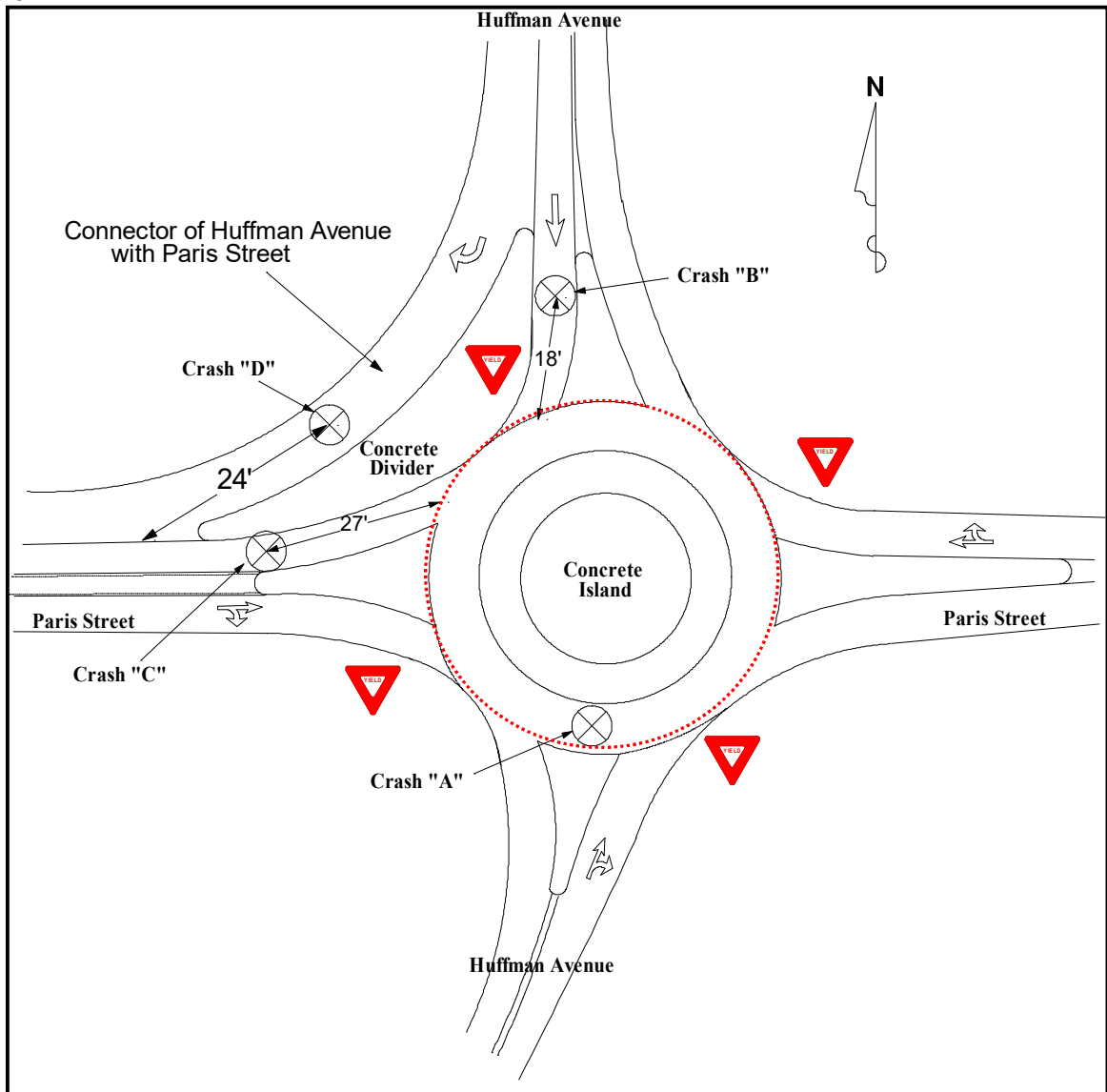

The area within the dashed circle in the above example is considered "At" the intersection of CST Huffman AVE and CST Paris ST.

**Crash "A":**

Crash "A" occurred within the boundaries of the roundabout circle and is located (*Section 2 - Location*) within the intersection. The location can be shown on the crash report as occurring on Paris Street or Huffman Avenue.

1. On CST Paris ST (Roadway Direction - "E"), At CST Huffman AVE. The direction of the intersecting roadway (Int. Dir.) is shown as either "N" or "S" because the crash occurred within the intersection.

ON CST Paris ST		RDWY. DIR. E	DISTANCE FROM NA Feet Miles	LOCATION After <input type="checkbox"/> NA Before <input type="checkbox"/> At <input checked="" type="checkbox"/>	INTERSECTING CST Huffman AVE			
SPEED LIMIT 35	ROADWAY MAINTAINED BY <input type="checkbox"/> State <input type="checkbox"/> County <input checked="" type="checkbox"/> Municipal <input type="checkbox"/> Private Property <input type="checkbox"/> Other				SPEED LIMIT 35	INT. DIR. N	GEO — CODE NA	
TRAFFICWAY <input checked="" type="checkbox"/> One-Way <input type="checkbox"/> Two-Way, Not Divided <input type="checkbox"/> Two-Way, Divided; Unprotected Median <input type="checkbox"/> Other <input type="checkbox"/> Two-Way, Not Divided; Continuous Center Turn Lane <input type="checkbox"/> Two-Way, Divided; Positive Median Barrier <input type="checkbox"/> Unknown				ROADWAY ALIGNMENT <input type="checkbox"/> Straight <input checked="" type="checkbox"/> Curve <input type="checkbox"/> Unknown (Explain)	ROADWAY PROFILE <input checked="" type="checkbox"/> Level <input type="checkbox"/> Downhill <input type="checkbox"/> Dip <input type="checkbox"/> Uphill <input type="checkbox"/> Hillcrest <input type="checkbox"/> Unknown (Explain)			
INTERSECTION TYPE <input type="checkbox"/> NA <input type="checkbox"/> Cross Intersection (4-Way) <input type="checkbox"/> Y-Intersection <input type="checkbox"/> T-Intersection				ANGLED / SKEWED <input type="checkbox"/> Y-Intersection <input type="checkbox"/> Five or More Legs and Not Circular	ROUNDABOUT / TRAFFIC CIRCLE <input checked="" type="checkbox"/> Roundabout <input type="checkbox"/> Other (Explain) <input type="checkbox"/> Other Circular Intersection <input type="checkbox"/> Unknown (Explain)	Enter Codes	ROADWAY CONDITION LIGHT CONDITION 1	ROADWAY SURFACE 1

2. On CST Huffman AVE (Roadway Direction - "N" or "S"), At CST Paris ST. The direction of the intersecting roadway (Int. Dir.) is shown as either "E" or "W" because the crash occurred within the intersection.

ON CST Huffman AVE		RDWY. DIR. N	DISTANCE FROM NA Feet Miles	LOCATION After <input type="checkbox"/> NA Before <input type="checkbox"/> At <input checked="" type="checkbox"/>	INTERSECTING CST Paris ST			
SPEED LIMIT 35	ROADWAY MAINTAINED BY <input type="checkbox"/> State <input type="checkbox"/> County <input checked="" type="checkbox"/> Municipal <input type="checkbox"/> Private Property <input type="checkbox"/> Other				SPEED LIMIT 35	INT. DIR. E	GEO — CODE NA	
TRAFFICWAY <input checked="" type="checkbox"/> One-Way <input type="checkbox"/> Two-Way, Not Divided <input type="checkbox"/> Two-Way, Divided; Unprotected Median <input type="checkbox"/> Other <input type="checkbox"/> Two-Way, Not Divided; Continuous Center Turn Lane <input type="checkbox"/> Two-Way, Divided; Positive Median Barrier <input type="checkbox"/> Unknown				ROADWAY ALIGNMENT <input type="checkbox"/> Straight <input checked="" type="checkbox"/> Curve <input type="checkbox"/> Unknown (Explain)	ROADWAY PROFILE <input checked="" type="checkbox"/> Level <input type="checkbox"/> Downhill <input type="checkbox"/> Dip <input type="checkbox"/> Uphill <input type="checkbox"/> Hillcrest <input type="checkbox"/> Unknown (Explain)			
INTERSECTION TYPE <input type="checkbox"/> NA <input type="checkbox"/> Cross Intersection (4-Way) <input type="checkbox"/> Y-Intersection <input type="checkbox"/> T-Intersection				ANGLED / SKEWED <input type="checkbox"/> Y-Intersection <input type="checkbox"/> Five or More Legs and Not Circular	ROUNDABOUT / TRAFFIC CIRCLE <input checked="" type="checkbox"/> Roundabout <input type="checkbox"/> Other (Explain) <input type="checkbox"/> Other Circular Intersection <input type="checkbox"/> Unknown (Explain)	Enter Codes	ROADWAY CONDITION LIGHT CONDITION 1	ROADWAY SURFACE 1

**Crash "B":**

Crash "B" is measured to the roundabout circle and is located (*Section 2 - Location*) On CST Huffman AVE (Roadway Direction - "S"), 18 feet Before CST Paris ST. The direction of the intersecting roadway (Int. Dir.) is "W" because the location was measured to the westbound lane of CST Paris ST.

ON CST Huffman AVE		RDWY. DIR. S	DISTANCE FROM 18 Feet Miles	LOCATION After <input type="checkbox"/> NA Before <input checked="" type="checkbox"/> At <input type="checkbox"/>	INTERSECTING CST Paris ST			
SPEED LIMIT 35	ROADWAY MAINTAINED BY <input type="checkbox"/> State <input type="checkbox"/> County <input checked="" type="checkbox"/> Municipal <input type="checkbox"/> Private Property <input type="checkbox"/> Other				SPEED LIMIT NA	INT. DIR. W	GEO — CODE NA	
TRAFFICWAY <input type="checkbox"/> One-Way <input type="checkbox"/> Two-Way, Not Divided <input checked="" type="checkbox"/> Two-Way, Divided; Unprotected Median <input type="checkbox"/> Other <input type="checkbox"/> Two-Way, Not Divided; Continuous Center Turn Lane <input type="checkbox"/> Two-Way, Divided; Positive Median Barrier <input type="checkbox"/> Unknown				ROADWAY ALIGNMENT <input type="checkbox"/> Straight <input type="checkbox"/> Curve <input type="checkbox"/> Unknown (Explain)	ROADWAY PROFILE <input checked="" type="checkbox"/> Level <input type="checkbox"/> Downhill <input type="checkbox"/> Dip <input type="checkbox"/> Uphill <input type="checkbox"/> Hillcrest <input type="checkbox"/> Unknown (Explain)			
INTERSECTION TYPE <input checked="" type="checkbox"/> NA <input type="checkbox"/> Cross Intersection (4-Way) <input type="checkbox"/> Y-Intersection <input type="checkbox"/> T-Intersection				ANGLED / SKEWED <input type="checkbox"/> Y-Intersection <input type="checkbox"/> Five or More Legs and Not Circular	ROUNDABOUT / TRAFFIC CIRCLE <input type="checkbox"/> Roundabout <input type="checkbox"/> Other (Explain) <input type="checkbox"/> Other Circular Intersection <input type="checkbox"/> Unknown (Explain)	Enter Codes	ROADWAY CONDITION LIGHT CONDITION 1	ROADWAY SURFACE 1

**Crash "C":**

Crash "C" is measured to the roundabout circle and is located (*Section 2 - Location*) On CST Paris ST (Roadway Direction - "W"), 27 feet After CST Huffman AVE. The direction of the intersecting roadway (Int. Dir.) is "S" because the location was measured to the southbound lane of CST Huffman AVE.

ON CST Paris ST		RDWY. DIR. W	DISTANCE FROM 27 Feet Miles	LOCATION After <input checked="" type="checkbox"/> NA Before <input type="checkbox"/> At <input type="checkbox"/>	INTERSECTING CST Huffman AVE			
SPEED LIMIT 35	ROADWAY MAINTAINED BY <input type="checkbox"/> State <input type="checkbox"/> County <input checked="" type="checkbox"/> Municipal <input type="checkbox"/> Private Property <input type="checkbox"/> Other				SPEED LIMIT NA	INT. DIR. S	GEO — CODE NA	
TRAFFICWAY <input type="checkbox"/> One-Way <input type="checkbox"/> Two-Way, Not Divided <input checked="" type="checkbox"/> Two-Way, Divided; Unprotected Median <input type="checkbox"/> Other <input type="checkbox"/> Two-Way, Not Divided; Continuous Center Turn Lane <input type="checkbox"/> Two-Way, Divided; Positive Median Barrier <input type="checkbox"/> Unknown				ROADWAY ALIGNMENT <input type="checkbox"/> Straight <input checked="" type="checkbox"/> Curve <input type="checkbox"/> Unknown (Explain)	ROADWAY PROFILE <input checked="" type="checkbox"/> Level <input type="checkbox"/> Downhill <input type="checkbox"/> Dip <input type="checkbox"/> Uphill <input type="checkbox"/> Hillcrest <input type="checkbox"/> Unknown (Explain)			
INTERSECTION TYPE <input checked="" type="checkbox"/> NA <input type="checkbox"/> Cross Intersection (4-Way) <input type="checkbox"/> Y-Intersection <input type="checkbox"/> T-Intersection				ANGLED / SKEWED <input type="checkbox"/> Y-Intersection <input type="checkbox"/> Five or More Legs and Not Circular	ROUNDABOUT / TRAFFIC CIRCLE <input type="checkbox"/> Roundabout <input type="checkbox"/> Other (Explain) <input type="checkbox"/> Other Circular Intersection <input type="checkbox"/> Unknown (Explain)	Enter Codes	ROADWAY CONDITION LIGHT CONDITION 1	ROADWAY SURFACE 1

**Crash "D":**

Crash "D" is in a right turn only lane, which is a connector between Huffman Avenue and Paris Street. The crash is located by measuring to the intersection of the connector with Paris Street. The location is shown on the crash report as occurring on CO (Connector) Huffman AVE to Paris ST (Roadway Direction - "S"), 24 feet Before CST Paris ST (Int. Dir. - "W").

ON CO Huffman AVE to Paris ST		RDWY. DIR. S	DISTANCE FROM 24 <input type="checkbox"/> NA Feet	LOCATION <input type="checkbox"/> After <input type="checkbox"/> NA <input checked="" type="checkbox"/> Before <input type="checkbox"/> At	INTERSECTING CST Paris ST					
SPEED LIMIT 35	ROADWAY MAINTAINED BY <input type="checkbox"/> Unknown <input type="checkbox"/> State <input type="checkbox"/> County <input checked="" type="checkbox"/> Municipal <input type="checkbox"/> Private Property <input type="checkbox"/> Other		<input type="checkbox"/> NA Miles	SPEED LIMIT NA				INT. DIR. W	GEO — CODE NA	
TRAFFICWAY <input checked="" type="checkbox"/> One-Way <input type="checkbox"/> Two-Way; Not Divided <input type="checkbox"/> Two-Way; Divided; Unprotected Median <input type="checkbox"/> Other <input type="checkbox"/> Two-Way; Not Divided; Continuous Center Turn Lane <input type="checkbox"/> Two-Way; Divided; Positive Median Barrier <input type="checkbox"/> Unknown			ROADWAY ALIGNMENT <input type="checkbox"/> Straight <input checked="" type="checkbox"/> Curve <input type="checkbox"/> Unknown (Explain)		ROADWAY PROFILE <input checked="" type="checkbox"/> Level <input type="checkbox"/> Downhill <input type="checkbox"/> Dip <input type="checkbox"/> Uphill <input type="checkbox"/> Hillcrest <input type="checkbox"/> Unknown (Explain)					
INTERSECTION TYPE <input checked="" type="checkbox"/> NA <input type="checkbox"/> Cross Intersection (4-Way) <input type="checkbox"/> T-Intersection			ANGLED / SKEWED <input type="checkbox"/> Y-Intersection <input type="checkbox"/> Five or More Legs and Not Circular		ROUNDBOUT / TRAFFIC CIRCLE <input type="checkbox"/> Roundabout <input type="checkbox"/> Other (Explain) <input type="checkbox"/> Other Circular Intersection <input type="checkbox"/> Unknown (Explain)		Enter Codes	ROADWAY CONDITION LIGHT CONDITION 1	1	ROADWAY SURFACE 1

## INTERCHANGES

Traffic crashes occurring within interchanges are located on the roadways on which they occur, i.e., ramps, overpasses, primary roadway, etc. and to the nearest roadway, gore, ERM, or bridge structure.

Ramp numbers must be used when a crash occurs on a ramp. The numbers can be found in the [MoDOT Interactive Mapping Tool](#). For example, a crash occurring on ramp number 6998, located on IS 70 eastbound at US 54, will be shown in this field as "RP 6998." The crashes should then be measured to the nearest roadway, painted gore (where the ramp leaves or joins a roadway - see diagrams below), or bridge structure. Ramps can overlap other ramps. The method for locating crashes on overlapping ramps is explained in [Examples #7 \(Diverging Diamond Interchanges\)](#) and [#8 \(Directional Interchanges\)](#) below.

### Diamond Interchanges

#### Example #1:

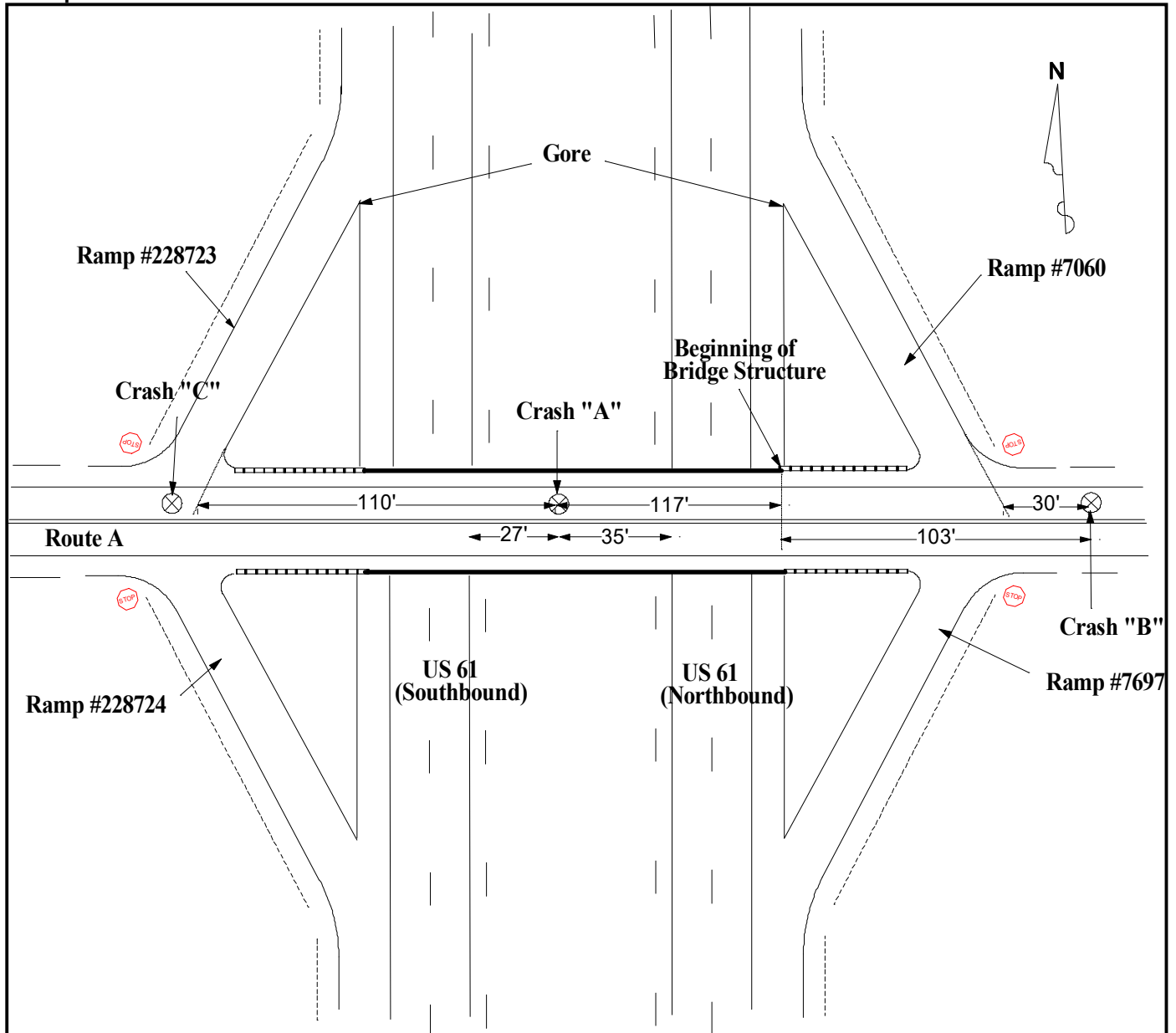

The fact that the crashes occurred within the interchange is immaterial as far as completion of the crash report is concerned. Crash "A" and Crash "B" can be located to the nearest roadways (including ramps) or to the beginning of the bridge structure and Crash "C" is located within the intersection of Ramp 228723 and Route A.

**Crash "A":**

Crash "A" can be measured to the beginning of the bridge structure in the eastbound lane (as shown in diagram), Ramp 228723 (as shown in diagram and below), Ramp 7060 (not shown), southbound lanes of US 61 (as shown in diagram), or northbound lanes of US 61 (as shown in diagram).

ON RT A		RDWY, DIR. W	DISTANCE FROM 110 Feet Miles	LOCATION <input type="checkbox"/> After <input type="checkbox"/> NA <input checked="" type="checkbox"/> Before <input type="checkbox"/> At	INTERSECTING RP 228723		
SPEED LIMIT 55	ROADWAY MAINTAINED BY <input checked="" type="checkbox"/> State <input type="checkbox"/> County <input type="checkbox"/> Municipal <input type="checkbox"/> Private Property <input type="checkbox"/> Other				SPEED LIMIT NA	INT. DIR. W	GEO — CODE NA
TRAFFICWAY <input type="checkbox"/> One-Way <input checked="" type="checkbox"/> Two-Way; Not Divided <input type="checkbox"/> Two-Way; Divided; Unprotected Median <input type="checkbox"/> Other <input type="checkbox"/> Two-Way; Not Divided; Continuous Center Turn Lane <input type="checkbox"/> Two-Way; Divided; Positive Median Barrier <input type="checkbox"/> Unknown			ROADWAY ALIGNMENT <input checked="" type="checkbox"/> Straight <input type="checkbox"/> Curve <input type="checkbox"/> Unknown (Explain)		ROADWAY PROFILE <input checked="" type="checkbox"/> Level <input type="checkbox"/> Downhill <input type="checkbox"/> Dip <input type="checkbox"/> Uphill <input type="checkbox"/> Hillcrest <input type="checkbox"/> Unknown (Explain)		
INTERSECTION TYPE <input checked="" type="checkbox"/> NA <input type="checkbox"/> Cross Intersection (4-Way) <input type="checkbox"/> Y-Intersection <input type="checkbox"/> T-Intersection				ANGLED / SKEWED <input type="checkbox"/> Y-Intersection <input type="checkbox"/> Five or More Legs and Not Circular		ROUNDBOUNT / TRAFFIC CIRCLE <input type="checkbox"/> Roundabout <input type="checkbox"/> Other Circular Intersection <input type="checkbox"/> Unknown (Explain)	
Enter Codes				ROADWAY CONDITION 1	ROADWAY SURFACE 1		
				LIGHT CONDITION 3	WEATHER / ENVIRON CONDITION 1		

**Crash "B":**

Crash "B" can be measured to Ramp 7060 (as shown in diagram and below) or to the beginning of the bridge structure in the eastbound lane (as shown in diagram). It could also be measured to any of the other roadways (including ramps).

ON RT A		RDWY, DIR. W	DISTANCE FROM 30 Feet Miles	LOCATION <input type="checkbox"/> After <input type="checkbox"/> NA <input checked="" type="checkbox"/> Before <input type="checkbox"/> At	INTERSECTING RP 7060		
SPEED LIMIT 55	ROADWAY MAINTAINED BY <input checked="" type="checkbox"/> State <input type="checkbox"/> County <input type="checkbox"/> Municipal <input type="checkbox"/> Private Property <input type="checkbox"/> Other				SPEED LIMIT NA	INT. DIR. N	GEO — CODE NA
TRAFFICWAY <input type="checkbox"/> One-Way <input checked="" type="checkbox"/> Two-Way; Not Divided <input type="checkbox"/> Two-Way; Divided; Unprotected Median <input type="checkbox"/> Other <input type="checkbox"/> Two-Way; Not Divided; Continuous Center Turn Lane <input type="checkbox"/> Two-Way; Divided; Positive Median Barrier <input type="checkbox"/> Unknown			ROADWAY ALIGNMENT <input checked="" type="checkbox"/> Straight <input type="checkbox"/> Curve <input type="checkbox"/> Unknown (Explain)		ROADWAY PROFILE <input checked="" type="checkbox"/> Level <input type="checkbox"/> Downhill <input type="checkbox"/> Dip <input type="checkbox"/> Uphill <input type="checkbox"/> Hillcrest <input type="checkbox"/> Unknown (Explain)		
INTERSECTION TYPE <input checked="" type="checkbox"/> NA <input type="checkbox"/> Cross Intersection (4-Way) <input type="checkbox"/> Y-Intersection <input type="checkbox"/> T-Intersection				ANGLED / SKEWED <input type="checkbox"/> Y-Intersection <input type="checkbox"/> Five or More Legs and Not Circular		ROUNDBOUNT / TRAFFIC CIRCLE <input type="checkbox"/> Roundabout <input type="checkbox"/> Other Circular Intersection <input type="checkbox"/> Unknown (Explain)	
Enter Codes				ROADWAY CONDITION 1	ROADWAY SURFACE 1		
				LIGHT CONDITION 3	WEATHER / ENVIRON CONDITION 1		

**Crash "C":**

Crash "C" occurred within the intersection of Ramp 228723 and Route A. It is located either on RT A at RP 228723 (shown below) or on RP 228723 At RT A.

ON RT A		RDWY, DIR. W	DISTANCE FROM <input checked="" type="checkbox"/> NA Feet Miles	LOCATION <input type="checkbox"/> After <input type="checkbox"/> NA <input type="checkbox"/> Before <input checked="" type="checkbox"/> At	INTERSECTING RP 228723		
SPEED LIMIT 55	ROADWAY MAINTAINED BY <input checked="" type="checkbox"/> State <input type="checkbox"/> County <input type="checkbox"/> Municipal <input type="checkbox"/> Private Property <input type="checkbox"/> Other				SPEED LIMIT 65	INT. DIR. W	GEO — CODE NA
TRAFFICWAY <input type="checkbox"/> One-Way <input checked="" type="checkbox"/> Two-Way; Not Divided <input type="checkbox"/> Two-Way; Divided; Unprotected Median <input type="checkbox"/> Other <input type="checkbox"/> Two-Way; Not Divided; Continuous Center Turn Lane <input type="checkbox"/> Two-Way; Divided; Positive Median Barrier <input type="checkbox"/> Unknown			ROADWAY ALIGNMENT <input checked="" type="checkbox"/> Straight <input type="checkbox"/> Curve <input type="checkbox"/> Unknown (Explain)		ROADWAY PROFILE <input checked="" type="checkbox"/> Level <input type="checkbox"/> Downhill <input type="checkbox"/> Dip <input type="checkbox"/> Uphill <input type="checkbox"/> Hillcrest <input type="checkbox"/> Unknown (Explain)		
INTERSECTION TYPE <input type="checkbox"/> NA <input checked="" type="checkbox"/> Cross Intersection (4-Way) <input type="checkbox"/> Y-Intersection <input type="checkbox"/> T-Intersection				ANGLED / SKEWED <input type="checkbox"/> Y-Intersection <input type="checkbox"/> Five or More Legs and Not Circular		ROUNDBOUNT / TRAFFIC CIRCLE <input type="checkbox"/> Roundabout <input type="checkbox"/> Other Circular Intersection <input type="checkbox"/> Unknown (Explain)	
Enter Codes				ROADWAY CONDITION 1	ROADWAY SURFACE 1		
				LIGHT CONDITION 3	WEATHER / ENVIRON CONDITION 1		

**Example #2:**

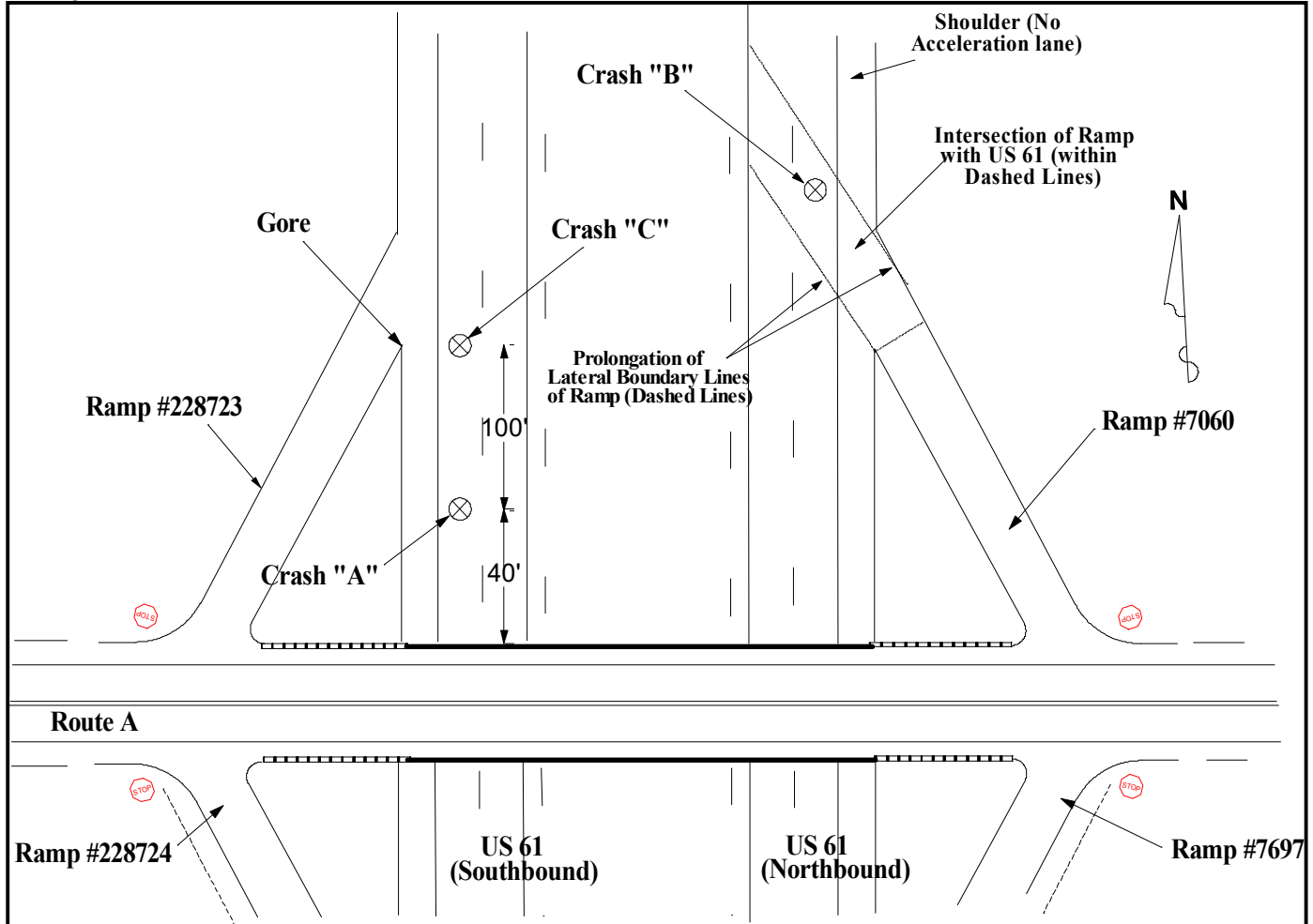

The fact that the crashes occurred within the interchange is immaterial as far as completion of the crash report is concerned. Crashes "A" and "C" can be located to the nearest roadway (westbound lane of Route A), to the painted gore on the corresponding ramp, or to the closest ERM (if on an Interstate). Crash "C" can also be located "At" the painted gore on the ramp. Crash "B" is located within the intersection of US 61 and the ramp (since there is no acceleration lane).

**Crash "A":**

Crash "A" can be measured to Route A (shown below) or the gore with Ramp #228723.

ON US 61		RDWY. DIR. S	DISTANCE FROM 40 <input type="checkbox"/> NA Feet	LOCATION <input type="checkbox"/> After <input type="checkbox"/> NA <input checked="" type="checkbox"/> Before <input type="checkbox"/> At	INTERSECTING RT A
SPEED LIMIT 65	ROADWAY MAINTAINED BY <input type="checkbox"/> Unknown <input checked="" type="checkbox"/> State <input type="checkbox"/> County <input type="checkbox"/> Municipal <input type="checkbox"/> Private Property <input type="checkbox"/> Other				SPEED LIMIT NA
TRAFFICWAY <input type="checkbox"/> One-Way <input type="checkbox"/> Two-Way, Not Divided <input checked="" type="checkbox"/> Two-Way, Divided, Unprotected Median <input type="checkbox"/> Other <input type="checkbox"/> Two-Way, Not Divided, Continuous Center Turn Lane <input type="checkbox"/> Two-Way, Divided, Positive Median Barrier <input type="checkbox"/> Unknown		ROADWAY ALIGNMENT <input checked="" type="checkbox"/> Straight <input type="checkbox"/> Curve <input type="checkbox"/> Unknown (Explain)		ROADWAY PROFILE <input checked="" type="checkbox"/> Level <input type="checkbox"/> Downhill <input type="checkbox"/> Dip <input type="checkbox"/> Uphill <input type="checkbox"/> Hillcrest <input type="checkbox"/> Unknown (Explain)	
INTERSECTION TYPE <input checked="" type="checkbox"/> NA <input type="checkbox"/> Cross Intersection (4-Way) <input type="checkbox"/> T-Intersection		ANGLED / SKEWED <input type="checkbox"/> Y-Intersection <input type="checkbox"/> Five or More Legs and Not Circular		ROUNDBOUNT / TRAFFIC CIRCLE <input type="checkbox"/> Roundabout <input type="checkbox"/> Other (Explain) <input type="checkbox"/> Other Circular Intersection <input type="checkbox"/> Unknown (Explain)	
Enter Codes		ROADWAY CONDITION 1	WEATHER / ENVIRON CONDITION 1	ROADWAY SURFACE 1	

**Crash "B":**

Crash "B" is within the intersection of the Northbound lanes of US 61 and Ramp #7060. It can be shown as occurring either On US 61 (Roadway Direction - "N") At RP 7060 (shown below) or On RP 7060 (Roadway Direction - "N") At US 61 (shown below). **This only applied because there is no acceleration (or deceleration) lane in the example. The crash would be measured to the nearest gore, roadway, or ERM if an acceleration lane had been present.**

ON US 61		RDWY. DIR. N	DISTANCE FROM <input checked="" type="checkbox"/> NA Feet Miles	LOCATION <input type="checkbox"/> After <input type="checkbox"/> NA <input type="checkbox"/> Before <input checked="" type="checkbox"/> At	INTERSECTING RP 7060		
SPEED LIMIT 65	ROADWAY MAINTAINED BY <input checked="" type="checkbox"/> State <input type="checkbox"/> County <input type="checkbox"/> Municipal <input type="checkbox"/> Private Property <input type="checkbox"/> Other				SPEED LIMIT 55	INT. DIR. N	GEO — CODE NA
TRAFFICWAY <input type="checkbox"/> One-Way <input type="checkbox"/> Two-Way, Not Divided <input checked="" type="checkbox"/> Two-Way, Divided, Unprotected Median <input type="checkbox"/> Other <input type="checkbox"/> Two-Way, Not Divided, Continuous Center Turn Lane <input type="checkbox"/> Two-Way, Divided, Positive Median Barrier <input type="checkbox"/> Unknown			ROADWAY ALIGNMENT <input checked="" type="checkbox"/> Straight <input type="checkbox"/> Curve <input type="checkbox"/> Unknown (Explain)		ROADWAY PROFILE <input checked="" type="checkbox"/> Level <input type="checkbox"/> Downhill <input type="checkbox"/> Dip <input type="checkbox"/> Uphill <input type="checkbox"/> Hillcrest <input type="checkbox"/> Unknown (Explain)		
INTERSECTION TYPE PERPENDICULAR <input type="checkbox"/> NA <input type="checkbox"/> Cross Intersection (4-Way) <input type="checkbox"/> T-Intersection				ANGLED / SKEWED <input checked="" type="checkbox"/> Y-Intersection <input type="checkbox"/> Five or More Legs and Not Circular		ROUNDBOUNT / TRAFFIC CIRCLE <input type="checkbox"/> Roundabout <input type="checkbox"/> Other (Explain) <input type="checkbox"/> Other Circular Intersection <input type="checkbox"/> Unknown (Explain)	
Enter Codes				ROADWAY CONDITION LIGHT CONDITION 1	1	WEATHER / ENVIRON CONDITION	ROADWAY SURFACE 1

ON RP 7060		RDWY. DIR. N	DISTANCE FROM <input checked="" type="checkbox"/> NA Feet Miles	LOCATION <input type="checkbox"/> After <input type="checkbox"/> NA <input type="checkbox"/> Before <input checked="" type="checkbox"/> At	INTERSECTING US 61		
SPEED LIMIT 55	ROADWAY MAINTAINED BY <input checked="" type="checkbox"/> State <input type="checkbox"/> County <input type="checkbox"/> Municipal <input type="checkbox"/> Private Property <input type="checkbox"/> Other				SPEED LIMIT 65	INT. DIR. N	GEO — CODE NA
TRAFFICWAY <input checked="" type="checkbox"/> One-Way <input type="checkbox"/> Two-Way, Not Divided <input type="checkbox"/> Two-Way, Divided, Unprotected Median <input type="checkbox"/> Other <input type="checkbox"/> Two-Way, Not Divided, Continuous Center Turn Lane <input type="checkbox"/> Two-Way, Divided, Positive Median Barrier <input type="checkbox"/> Unknown			ROADWAY ALIGNMENT <input checked="" type="checkbox"/> Straight <input type="checkbox"/> Curve <input type="checkbox"/> Unknown (Explain)		ROADWAY PROFILE <input checked="" type="checkbox"/> Level <input type="checkbox"/> Downhill <input type="checkbox"/> Dip <input type="checkbox"/> Uphill <input type="checkbox"/> Hillcrest <input type="checkbox"/> Unknown (Explain)		
INTERSECTION TYPE PERPENDICULAR <input type="checkbox"/> NA <input type="checkbox"/> Cross Intersection (4-Way) <input type="checkbox"/> T-Intersection				ANGLED / SKEWED <input checked="" type="checkbox"/> Y-Intersection <input type="checkbox"/> Five or More Legs and Not Circular		ROUNDBOUNT / TRAFFIC CIRCLE <input type="checkbox"/> Roundabout <input type="checkbox"/> Other (Explain) <input type="checkbox"/> Other Circular Intersection <input type="checkbox"/> Unknown (Explain)	
Enter Codes				ROADWAY CONDITION LIGHT CONDITION 1	1	WEATHER / ENVIRON CONDITION	ROADWAY SURFACE 1

**Crash "C":**

Crash "C" occurred on US 61 At the painted gore with Ramp 228723. It can be located at the gore (shown below) or measured to Route A.

Note: "Intersection Type" is shown as "NA" because this location does not meet the definition of an intersection.

ON US 61		RDWY. DIR. S	DISTANCE FROM <input checked="" type="checkbox"/> NA Feet Miles	LOCATION <input type="checkbox"/> After <input type="checkbox"/> NA <input type="checkbox"/> Before <input checked="" type="checkbox"/> At	INTERSECTING RP 228723		
SPEED LIMIT 65	ROADWAY MAINTAINED BY <input checked="" type="checkbox"/> State <input type="checkbox"/> County <input type="checkbox"/> Municipal <input type="checkbox"/> Private Property <input type="checkbox"/> Other				SPEED LIMIT 65	INT. DIR. W	GEO — CODE NA
TRAFFICWAY <input type="checkbox"/> One-Way <input type="checkbox"/> Two-Way, Not Divided <input checked="" type="checkbox"/> Two-Way, Divided, Unprotected Median <input type="checkbox"/> Other <input type="checkbox"/> Two-Way, Not Divided, Continuous Center Turn Lane <input type="checkbox"/> Two-Way, Divided, Positive Median Barrier <input type="checkbox"/> Unknown			ROADWAY ALIGNMENT <input checked="" type="checkbox"/> Straight <input type="checkbox"/> Curve <input type="checkbox"/> Unknown (Explain)		ROADWAY PROFILE <input checked="" type="checkbox"/> Level <input type="checkbox"/> Downhill <input type="checkbox"/> Dip <input type="checkbox"/> Uphill <input type="checkbox"/> Hillcrest <input type="checkbox"/> Unknown (Explain)		
INTERSECTION TYPE PERPENDICULAR <input checked="" type="checkbox"/> NA <input type="checkbox"/> Cross Intersection (4-Way) <input type="checkbox"/> T-Intersection				ANGLED / SKEWED <input type="checkbox"/> Y-Intersection <input type="checkbox"/> Five or More Legs and Not Circular		ROUNDBOUNT / TRAFFIC CIRCLE <input type="checkbox"/> Roundabout <input type="checkbox"/> Other (Explain) <input type="checkbox"/> Other Circular Intersection <input type="checkbox"/> Unknown (Explain)	
Enter Codes				ROADWAY CONDITION LIGHT CONDITION 1	1	WEATHER / ENVIRON CONDITION	ROADWAY SURFACE 1

**Example #3:**

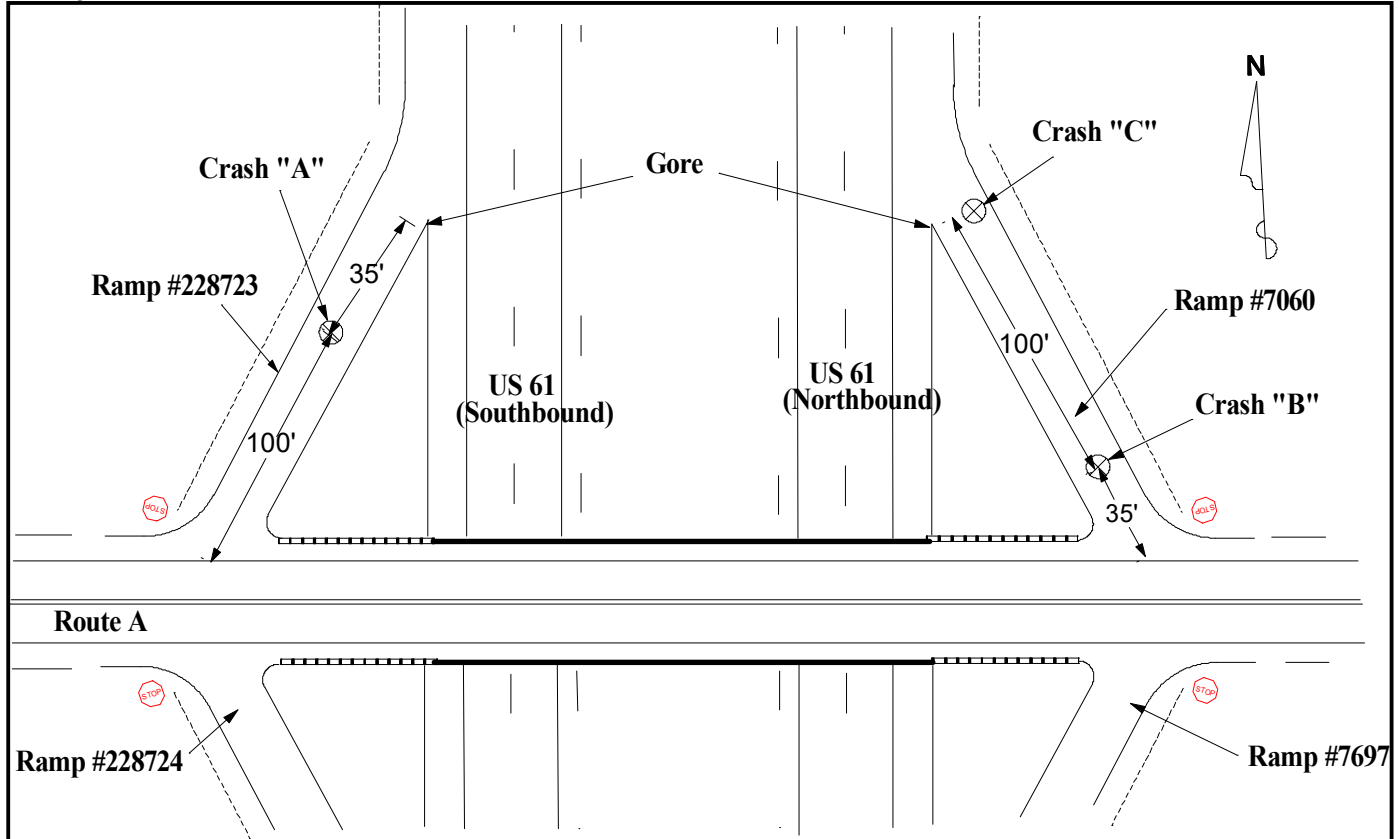

The fact that the crashes occurred within the interchange is immaterial as far as completion of the crash report is concerned. Crashes "A" and "B" can be located to the nearest roadway (westbound lane of Route A) or to the painted gore on the corresponding ramp. Crash "C" is located "At" the painted gore on the ramp.

**Crash "A":**

Crash "A" can be measured to the gore with US 61 or to Route A (shown below).

ON RP 228723		RDWY. DIR. W	DISTANCE FROM 100	LOCATION <input type="checkbox"/> After <input type="checkbox"/> NA <input checked="" type="checkbox"/> Before <input type="checkbox"/> At	INTERSECTING RT A
SPEED LIMIT 65	ROADWAY MAINTAINED BY <input checked="" type="checkbox"/> State <input type="checkbox"/> County <input type="checkbox"/> Municipal <input type="checkbox"/> Private Property <input type="checkbox"/> Other		Feet Miles		SPEED LIMIT NA
TRAFFICWAY <input checked="" type="checkbox"/> One-Way <input type="checkbox"/> Two-Way, Not Divided <input type="checkbox"/> Two-Way, Divided, Unprotected Median <input type="checkbox"/> Other <input type="checkbox"/> Two-Way, Not Divided, Continuous Center Turn Lane <input type="checkbox"/> Two-Way, Divided, Positive Median Barrier <input type="checkbox"/> Unknown			ROADWAY ALIGNMENT <input checked="" type="checkbox"/> Straight <input type="checkbox"/> Curve <input type="checkbox"/> Unknown (Explain)		ROADWAY PROFILE <input type="checkbox"/> Level <input type="checkbox"/> Downhill <input type="checkbox"/> Dip <input checked="" type="checkbox"/> Uphill <input type="checkbox"/> Hillcrest <input type="checkbox"/> Unknown (Explain)
INTERSECTION TYPE <input checked="" type="checkbox"/> NA <input type="checkbox"/> Cross Intersection (4-Way) <input type="checkbox"/> Y-Intersection <input type="checkbox"/> T-Intersection			ROUNDABOUT / TRAFFIC CIRCLE <input type="checkbox"/> Roundabout <input type="checkbox"/> Other (Explain) <input type="checkbox"/> Other Circular Intersection <input type="checkbox"/> Unknown (Explain)		ROADWAY CONDITION 2
			ROADWAY SURFACE 1		LIGHT CONDITION 3
			WEATHER / ENVIRON CONDITION 3		

**Crash "B":**

Crash "B" can be measured to the gore with US 61 (shown below) or to Route A.

ON RP 7060		RDWY. DIR. N	DISTANCE FROM 100	LOCATION <input type="checkbox"/> After <input type="checkbox"/> NA <input checked="" type="checkbox"/> Before <input type="checkbox"/> At	INTERSECTING US 61
SPEED LIMIT 55	ROADWAY MAINTAINED BY <input checked="" type="checkbox"/> State <input type="checkbox"/> County <input type="checkbox"/> Municipal <input type="checkbox"/> Private Property <input type="checkbox"/> Other		Feet Miles		SPEED LIMIT NA
TRAFFICWAY <input checked="" type="checkbox"/> One-Way <input type="checkbox"/> Two-Way, Not Divided <input type="checkbox"/> Two-Way, Divided, Unprotected Median <input type="checkbox"/> Other <input type="checkbox"/> Two-Way, Not Divided, Continuous Center Turn Lane <input type="checkbox"/> Two-Way, Divided, Positive Median Barrier <input type="checkbox"/> Unknown			ROAD ALIGNMENT <input checked="" type="checkbox"/> Straight <input type="checkbox"/> Curve <input type="checkbox"/> Unknown (Explain)		ROAD PROFILE <input type="checkbox"/> Level <input checked="" type="checkbox"/> Downhill <input type="checkbox"/> Dip <input type="checkbox"/> Uphill <input type="checkbox"/> Hillcrest <input type="checkbox"/> Unknown (Explain)
INTERSECTION TYPE <input checked="" type="checkbox"/> NA <input type="checkbox"/> Cross Intersection (4-Way) <input type="checkbox"/> Y-Intersection <input type="checkbox"/> T-Intersection			ROUNDABOUT / TRAFFIC CIRCLE <input type="checkbox"/> Roundabout <input type="checkbox"/> Other (Explain) <input type="checkbox"/> Other Circular Intersection <input type="checkbox"/> Unknown (Explain)		ROADWAY CONDITION 2
			ROADWAY SURFACE 1		LIGHT CONDITION 3
			WEATHER / ENVIRON CONDITION 3		



**Crash "C":**

Crash "C" occurred on RP 7060 At US 61. It can be located at the gore (shown below) or measured to Route A.

Note: "Intersection Type" is shown as "NA" because this location does not meet the definition of an intersection.

ON RP 7060		RDWY. DIR. N	DISTANCE FROM NA Feet Miles	LOCATION <input type="checkbox"/> After <input type="checkbox"/> NA <input type="checkbox"/> Before <input checked="" type="checkbox"/> At	INTERSECTING US 61		
SPEED LIMIT 55	ROADWAY MAINTAINED BY <input checked="" type="checkbox"/> State <input type="checkbox"/> County <input type="checkbox"/> Municipal <input type="checkbox"/> Private Property <input type="checkbox"/> Other				SPEED LIMIT 65	INT. DIR. N	GEO — CODE NA
TRAFFICWAY <input checked="" type="checkbox"/> One-Way <input type="checkbox"/> Two-Way, Not Divided <input type="checkbox"/> Two-Way; Divided; Unprotected Median <input type="checkbox"/> Other <input type="checkbox"/> Two-Way, Not Divided; Continuous Center Turn Lane <input type="checkbox"/> Two-Way; Divided; Positive Median Barrier <input type="checkbox"/> Unknown				ROADWAY ALIGNMENT <input checked="" type="checkbox"/> Straight <input type="checkbox"/> Curve <input type="checkbox"/> Unknown (Explain)	ROADWAY PROFILE <input type="checkbox"/> Level <input checked="" type="checkbox"/> Downhill <input type="checkbox"/> Dip <input type="checkbox"/> Uphill <input type="checkbox"/> Hillcrest <input type="checkbox"/> Unknown (Explain)		
INTERSECTION TYPE <input checked="" type="checkbox"/> NA				Enter Codes	ROADWAY CONDITION LIGHT CONDITION 3	WEATHER / ENVIRON CONDITION 2	ROADWAY SURFACE 1
PERPENDICULAR <input type="checkbox"/> Cross Intersection (4-Way) <input type="checkbox"/> T-Intersection		ANGLED / SKEWED <input type="checkbox"/> Y-Intersection <input type="checkbox"/> Five or More Legs and Not Circular		ROUNDABOUT / TRAFFIC CIRCLE <input type="checkbox"/> Roundabout <input type="checkbox"/> Other Circular Intersection		Other (Explain) <input type="checkbox"/> Unknown (Explain)	

**Coverleaf Interchange**

**Example #4:**

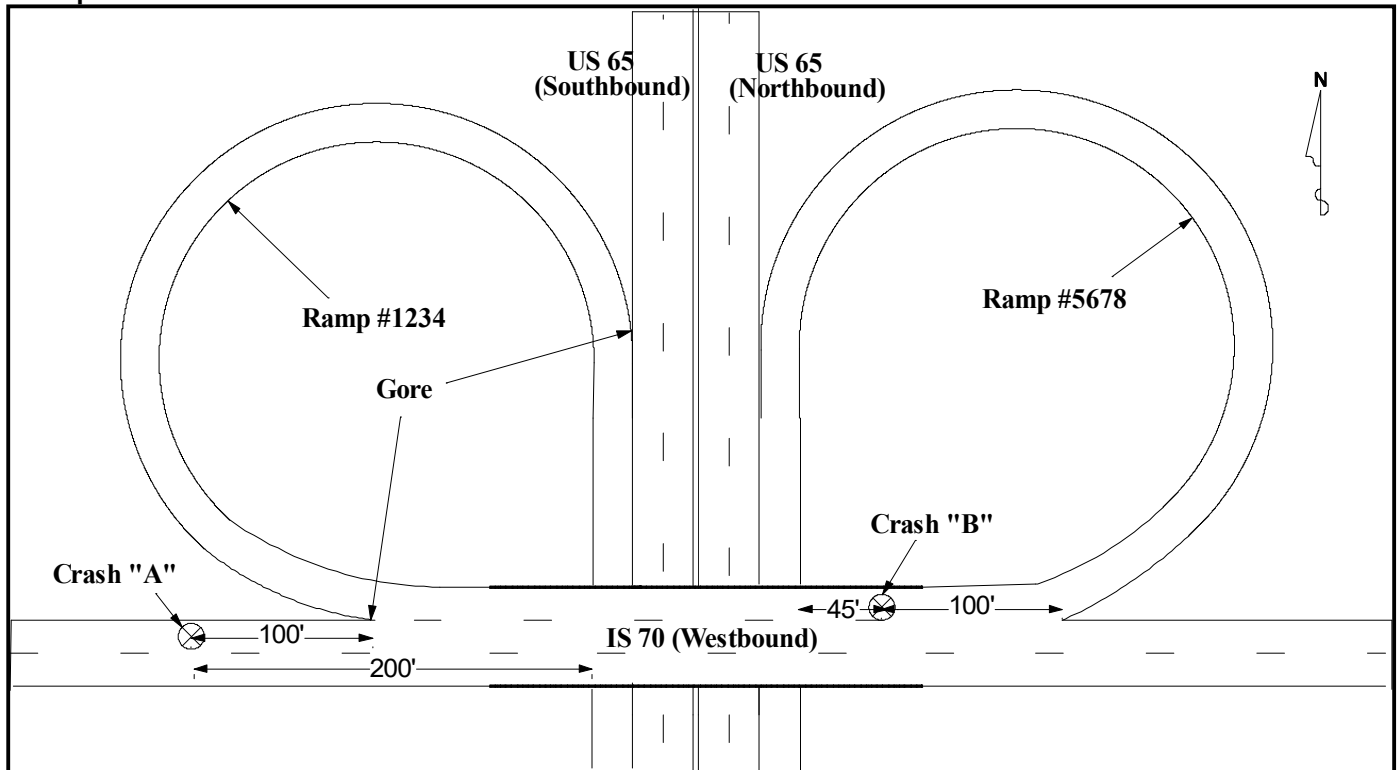

The fact that the crashes occurred within the interchange is immaterial as far as completion of the crash report is concerned. Crash "A" and Crash "B" can be located to the gores of the nearest ramps, to the beginning of the bridge structure, or to the nearest ERM.

**Crash "A":**

Crash "A" can be measured to the gore with Ramp 1234 (shown below), the southbound lanes of US 65, the beginning of the bridge structure (not shown on diagram), or to the nearest ERM (not shown on diagram).

ON IS 70		RDWY. DIR. W	DISTANCE FROM 100	LOCATION <input checked="" type="checkbox"/> After <input type="checkbox"/> NA <input type="checkbox"/> Before <input type="checkbox"/> At	INTERSECTING RP 1234
SPEED LIMIT 70	ROADWAY MAINTAINED BY <input checked="" type="checkbox"/> State <input type="checkbox"/> County <input type="checkbox"/> Municipal <input type="checkbox"/> Private Property <input type="checkbox"/> Other		Feet Miles		SPEED LIMIT INT. DIR. GEO — CODE NA S NA
TRAFFICWAY <input type="checkbox"/> One-Way <input type="checkbox"/> Two-Way; Not Divided <input checked="" type="checkbox"/> Two-Way; Divided; Unprotected Median <input type="checkbox"/> Other <input type="checkbox"/> Two-Way; Not Divided; Continuous Center Turn Lane <input type="checkbox"/> Two-Way; Divided; Positive Median Barrier <input type="checkbox"/> Unknown			ROADWAY ALIGNMENT <input checked="" type="checkbox"/> Straight <input type="checkbox"/> Curve <input type="checkbox"/> Unknown (Explain)		ROADWAY PROFILE <input type="checkbox"/> Level <input type="checkbox"/> Downhill <input type="checkbox"/> Dip <input type="checkbox"/> Uphill <input checked="" type="checkbox"/> Hillcrest <input type="checkbox"/> Unknown (Explain)
INTERSECTION TYPE <input checked="" type="checkbox"/> NA <input type="checkbox"/> Cross Intersection (4-Way) <input type="checkbox"/> T-Intersection		ANGLED / SKEWED <input type="checkbox"/> Y-Intersection <input type="checkbox"/> Five or More Legs and Not Circular		ROUNDBOUNT / TRAFFIC CIRCLE <input type="checkbox"/> Roundabout <input type="checkbox"/> Other (Explain) <input type="checkbox"/> Other Circular Intersection <input type="checkbox"/> Unknown (Explain)	
Enter Codes		ROADWAY CONDITION 1	ROADWAY SURFACE 1		WEATHER / ENVIRON CONDITION 1

**Crash "B":**

Crash "B" can be measured to the gore with Ramp 5678, the northbound lanes of US 65 (shown below), beginning of the bridge structure (not shown on the diagram), or to the nearest ERM (not shown on the diagram).

ON IS 70		RDWY. DIR. W	DISTANCE FROM 45	LOCATION <input type="checkbox"/> After <input type="checkbox"/> NA <input checked="" type="checkbox"/> Before <input type="checkbox"/> At	INTERSECTING US 65
SPEED LIMIT 70	ROADWAY MAINTAINED BY <input checked="" type="checkbox"/> State <input type="checkbox"/> County <input type="checkbox"/> Municipal <input type="checkbox"/> Private Property <input type="checkbox"/> Other		Feet Miles		SPEED LIMIT INT. DIR. GEO — CODE NA N NA
TRAFFICWAY <input type="checkbox"/> One-Way <input type="checkbox"/> Two-Way; Not Divided <input checked="" type="checkbox"/> Two-Way; Divided; Unprotected Median <input type="checkbox"/> Other <input type="checkbox"/> Two-Way; Not Divided; Continuous Center Turn Lane <input type="checkbox"/> Two-Way; Divided; Positive Median Barrier <input type="checkbox"/> Unknown			ROADWAY ALIGNMENT <input checked="" type="checkbox"/> Straight <input type="checkbox"/> Curve <input type="checkbox"/> Unknown (Explain)		ROADWAY PROFILE <input type="checkbox"/> Level <input type="checkbox"/> Downhill <input type="checkbox"/> Dip <input type="checkbox"/> Uphill <input checked="" type="checkbox"/> Hillcrest <input type="checkbox"/> Unknown (Explain)
INTERSECTION TYPE <input checked="" type="checkbox"/> NA <input type="checkbox"/> Cross Intersection (4-Way) <input type="checkbox"/> T-Intersection		ANGLED / SKEWED <input type="checkbox"/> Y-Intersection <input type="checkbox"/> Five or More Legs and Not Circular		ROUNDBOUNT / TRAFFIC CIRCLE <input type="checkbox"/> Roundabout <input type="checkbox"/> Other (Explain) <input type="checkbox"/> Other Circular Intersection <input type="checkbox"/> Unknown (Explain)	
Enter Codes		ROADWAY CONDITION 1	ROADWAY SURFACE 1		WEATHER / ENVIRON CONDITION 1

**Example #5:**

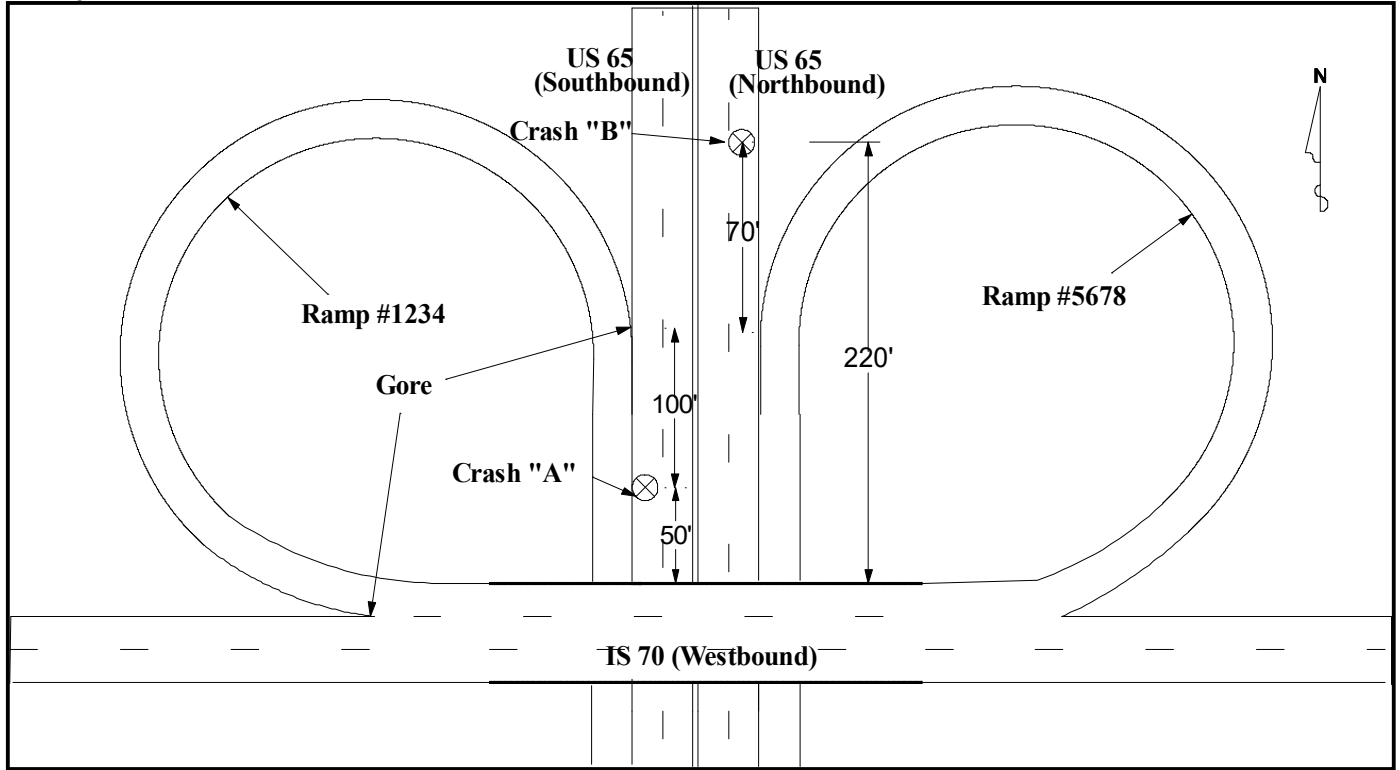

The fact that the crashes occurred within the interchange is immaterial as far as completion of the crash report is concerned. The crashes can be located to the nearest roadway (westbound lane of IS 70) or to the painted gore on the corresponding ramp.

**Crash "A":**

Crash "A" can be measured to IS 70 (shown below) or the gore with Ramp #1234.

ON US 65		RDWY. DIR. S	DISTANCE FROM 50 Feet <input type="checkbox"/> NA	LOCATION <input type="checkbox"/> After <input type="checkbox"/> NA <input checked="" type="checkbox"/> Before <input type="checkbox"/> At	INTERSECTING IS 70		
SPEED LIMIT 65	ROADWAY MAINTAINED BY <input checked="" type="checkbox"/> State <input type="checkbox"/> County <input type="checkbox"/> Municipal <input type="checkbox"/> Private Property <input type="checkbox"/> Other		50 Feet Miles	SPEED LIMIT NA		INT. DIR. W	GEO — CODE NA
TRAFFICWAY <input type="checkbox"/> One-Way <input checked="" type="checkbox"/> Two-Way, Not Divided <input type="checkbox"/> Two-Way, Divided, Unprotected Median <input type="checkbox"/> Other <input type="checkbox"/> Two-Way, Not Divided, Continuous Center Turn Lane <input type="checkbox"/> Two-Way, Divided, Positive Median Barrier <input type="checkbox"/> Unknown			ROADWAY ALIGNMENT <input checked="" type="checkbox"/> Straight <input type="checkbox"/> Curve <input type="checkbox"/> Unknown (Explain)		ROADWAY PROFILE <input checked="" type="checkbox"/> Level <input type="checkbox"/> Downhill <input type="checkbox"/> Dip <input type="checkbox"/> Uphill <input type="checkbox"/> Hillcrest <input type="checkbox"/> Unknown (Explain)		
INTERSECTION TYPE PERPENDICULAR <input checked="" type="checkbox"/> NA <input type="checkbox"/> Cross Intersection (4-Way) <input type="checkbox"/> T-Intersection			ANGLED / SKEWED <input type="checkbox"/> Y-Intersection <input type="checkbox"/> Five or More Legs and Not Circular		ROUNDBOUNT / TRAFFIC CIRCLE <input type="checkbox"/> Roundabout <input type="checkbox"/> Other (Explain) <input type="checkbox"/> Other Circular Intersection <input type="checkbox"/> Unknown (Explain)		Enter Codes ROADWAY CONDITION LIGHT CONDITION 1
			ROADWAY CONDITION 4		ROADWAY SURFACE 1		WEATHER / ENVIRON CONDITION 2 6

**Crash "B":**

Crash "B" can be measured to IS 70 or the gore with Ramp #5678 (shown below).

ON US 65		RDWY. DIR. N	DISTANCE FROM 70 Feet <input type="checkbox"/> NA	LOCATION <input checked="" type="checkbox"/> After <input type="checkbox"/> NA <input type="checkbox"/> Before <input type="checkbox"/> At	INTERSECTING RP 5678		
SPEED LIMIT 65	ROADWAY MAINTAINED BY <input checked="" type="checkbox"/> State <input type="checkbox"/> County <input type="checkbox"/> Municipal <input type="checkbox"/> Private Property <input type="checkbox"/> Other		70 Feet Miles	SPEED LIMIT NA		INT. DIR. W	GEO — CODE NA
TRAFFICWAY <input type="checkbox"/> One-Way <input type="checkbox"/> Two-Way, Not Divided <input type="checkbox"/> Two-Way, Divided, Unprotected Median <input type="checkbox"/> Other <input type="checkbox"/> Two-Way, Not Divided, Continuous Center Turn Lane <input checked="" type="checkbox"/> Two-Way, Divided, Positive Median Barrier <input type="checkbox"/> Unknown			ROADWAY ALIGNMENT <input checked="" type="checkbox"/> Straight <input type="checkbox"/> Curve <input type="checkbox"/> Unknown (Explain)		ROADWAY PROFILE <input checked="" type="checkbox"/> Level <input type="checkbox"/> Downhill <input type="checkbox"/> Dip <input type="checkbox"/> Uphill <input type="checkbox"/> Hillcrest <input type="checkbox"/> Unknown (Explain)		
INTERSECTION TYPE PERPENDICULAR <input checked="" type="checkbox"/> NA <input type="checkbox"/> Cross Intersection (4-Way) <input type="checkbox"/> T-Intersection			ANGLED / SKEWED <input type="checkbox"/> Y-Intersection <input type="checkbox"/> Five or More Legs and Not Circular		ROUNDBOUNT / TRAFFIC CIRCLE <input type="checkbox"/> Roundabout <input type="checkbox"/> Other (Explain) <input type="checkbox"/> Other Circular Intersection <input type="checkbox"/> Unknown (Explain)		Enter Codes ROADWAY CONDITION LIGHT CONDITION 1
			ROADWAY CONDITION 4		ROADWAY SURFACE 1		WEATHER / ENVIRON CONDITION 2 6

**Example #6:**

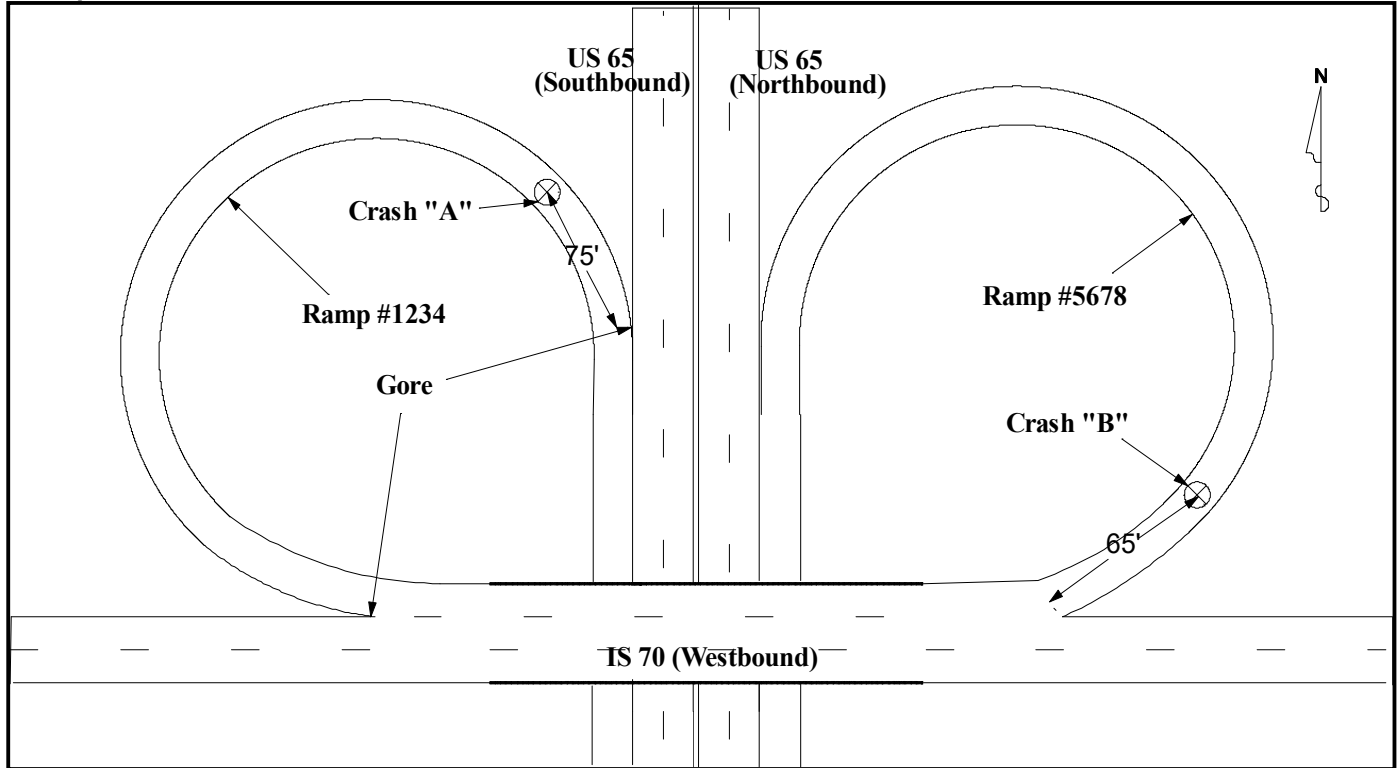

The fact that the crashes occurred within the interchange is immaterial as far as completion of the crash report is concerned. The crashes can be located to the painted gore on either end of the ramp. The Roadway Direction indicates the direction of the roadway to which the ramp is entering.

**Crash "A":**

Crash "A" can be measured to the gore with southbound US 65 (shown below) or back around the ramp to the gore with westbound IS 70 (not shown on diagram). The Roadway Direction is "S" because the ramp is entering US 65 Southbound.

ON RP 1234		RDWY. DIR. S	DISTANCE FROM 75 <input type="checkbox"/> NA Feet Miles	LOCATION <input type="checkbox"/> After <input type="checkbox"/> NA <input checked="" type="checkbox"/> Before <input type="checkbox"/> At	INTERSECTING US 65	
SPEED LIMIT 70	ROADWAY MAINTAINED BY <input type="checkbox"/> Unknown <input checked="" type="checkbox"/> State <input type="checkbox"/> County <input type="checkbox"/> Municipal <input type="checkbox"/> Private Property <input type="checkbox"/> Other				SPEED LIMIT NA	INT. DIR. S
TRAFFICWAY <input checked="" type="checkbox"/> One-Way <input type="checkbox"/> Two-Way, Not Divided <input type="checkbox"/> Two-Way, Divided, Unprotected Median <input type="checkbox"/> Other <input type="checkbox"/> Two-Way, Not Divided, Continuous Center Turn Lane <input type="checkbox"/> Two-Way, Divided, Positive Median Barrier <input type="checkbox"/> Unknown			ROADWAY ALIGNMENT <input type="checkbox"/> Straight <input checked="" type="checkbox"/> Curve <input type="checkbox"/> Unknown (Explain)		ROADWAY PROFILE <input type="checkbox"/> Level <input checked="" type="checkbox"/> Downhill <input type="checkbox"/> Dip <input type="checkbox"/> Uphill <input type="checkbox"/> Hillcrest <input type="checkbox"/> Unknown (Explain)	
INTERSECTION TYPE <input checked="" type="checkbox"/> NA <input type="checkbox"/> Cross Intersection (4-Way) <input type="checkbox"/> T-Intersection			ANGLED / SKEWED <input type="checkbox"/> Y-Intersection <input type="checkbox"/> Five or More Legs and Not Circular		ROUNDABOUT / TRAFFIC CIRCLE <input type="checkbox"/> Roundabout <input type="checkbox"/> Other Circular Intersection <input type="checkbox"/> Other (Explain) <input type="checkbox"/> Unknown (Explain)	
Enter Codes			ROADWAY CONDITION 1	ROADWAY SURFACE 1	LIGHT CONDITION 1	
			WEATHER / ENVIRON CONDITION 1	6		

**Crash "B":**

Crash "B" can be measured to the gore with westbound IS 70 (shown below) or back around the ramp to the gore with northbound US 65 (not shown on diagram). The Roadway Direction is "W" because the ramp is entering IS-70 Westbound.

ON RP 5678		RDWY. DIR. W	DISTANCE FROM 65 <input type="checkbox"/> NA Feet Miles	LOCATION <input type="checkbox"/> After <input type="checkbox"/> NA <input checked="" type="checkbox"/> Before <input type="checkbox"/> At	INTERSECTING IS 70	
SPEED LIMIT 65	ROADWAY MAINTAINED BY <input type="checkbox"/> Unknown <input checked="" type="checkbox"/> State <input type="checkbox"/> County <input type="checkbox"/> Municipal <input type="checkbox"/> Private Property <input type="checkbox"/> Other				SPEED LIMIT NA	INT. DIR. W
TRAFFICWAY <input type="checkbox"/> One-Way <input type="checkbox"/> Two-Way, Not Divided <input type="checkbox"/> Two-Way, Divided, Unprotected Median <input type="checkbox"/> Other <input type="checkbox"/> Two-Way, Not Divided, Continuous Center Turn Lane <input type="checkbox"/> Two-Way, Divided, Positive Median Barrier <input type="checkbox"/> Unknown			ROADWAY ALIGNMENT <input type="checkbox"/> Straight <input checked="" type="checkbox"/> Curve <input type="checkbox"/> Unknown (Explain)		ROADWAY PROFILE <input checked="" type="checkbox"/> Level <input type="checkbox"/> Downhill <input type="checkbox"/> Dip <input type="checkbox"/> Uphill <input type="checkbox"/> Hillcrest <input type="checkbox"/> Unknown (Explain)	
INTERSECTION TYPE <input checked="" type="checkbox"/> NA <input type="checkbox"/> Cross Intersection (4-Way) <input type="checkbox"/> T-Intersection			ANGLED / SKEWED <input type="checkbox"/> Y-Intersection <input type="checkbox"/> Five or More Legs and Not Circular		ROUNDABOUT / TRAFFIC CIRCLE <input type="checkbox"/> Roundabout <input type="checkbox"/> Other Circular Intersection <input type="checkbox"/> Other (Explain) <input type="checkbox"/> Unknown (Explain)	
Enter Codes			ROADWAY CONDITION 1	ROADWAY SURFACE 1	LIGHT CONDITION 1	
			WEATHER / ENVIRON CONDITION 1	6		

## Diverging Diamond Interchange

Crashes are located in and around a diverging diamond interchange in the same method as any other interchange. Examples are provided due to the unique characteristics of this type of interchange. This also provides examples of locating crashes on overlapping ramps. In the case of overlapping ramps, it may be necessary to examine more than one roadway listing from the [MoDOT Interactive Mapping Tool](#) in order to determine the numbers of each ramp once they separate.

### Example #7

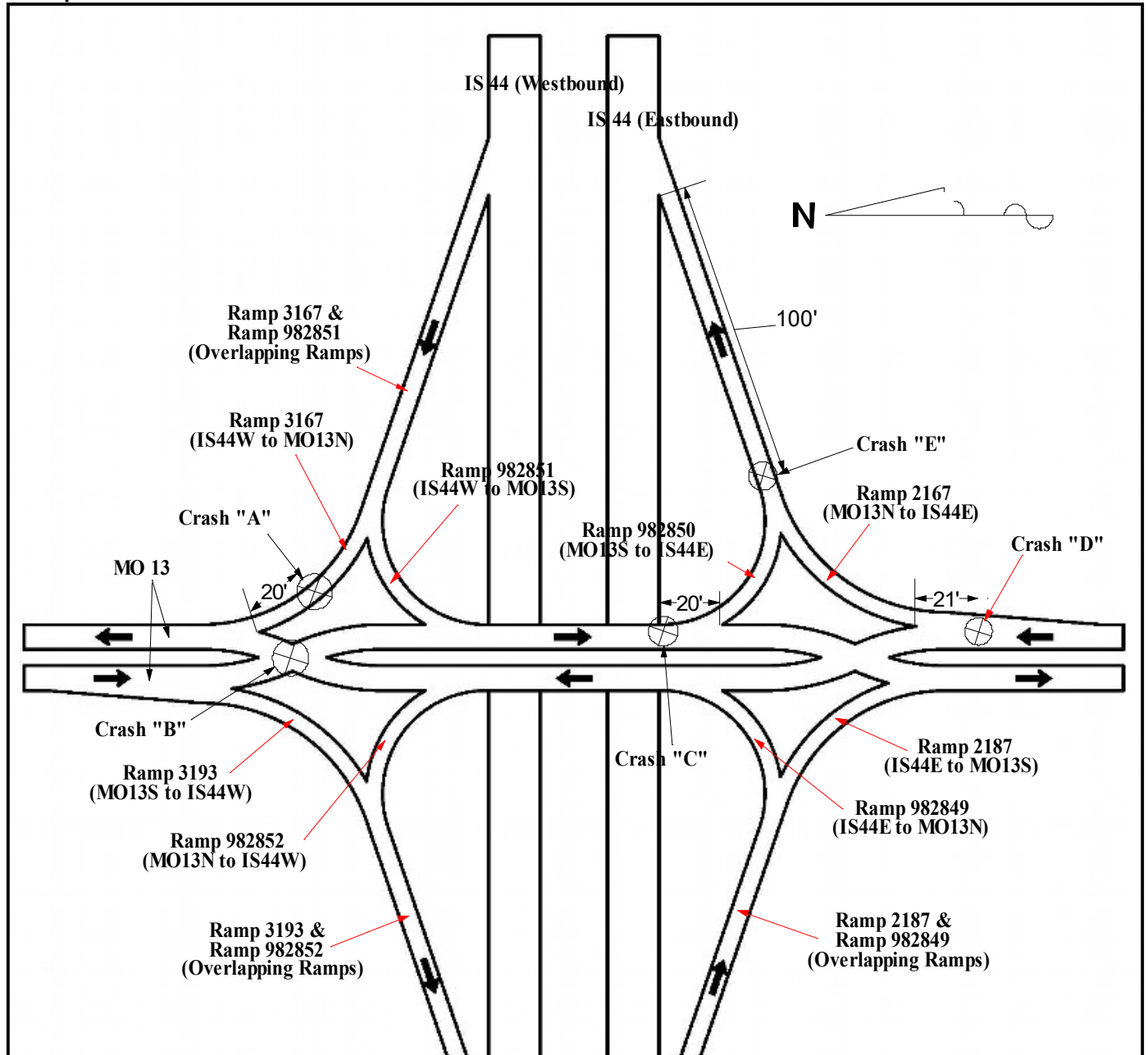

The fact that the crashes occurred within the interchange is immaterial as far as completion of the crash report is concerned. Crashes "C" and "D" can be located to the nearest roadways (including ramps) or to the beginning of the bridge structure. Crash "A" is located on the ramp and can only be measured to the nearest painted gore with MO 13. Crash "E" is located on either of the overlapping ramps and can only be measured to the painted gore with IS 44. Crash "B" is located within the intersection of MO 13 North and MO 13 South.

An example from the [MoDOT Interactive Mapping Tool](#) showing MO 13 N as it approaches, crosses, and departs IS 44 is as follows and is used in the examples for Crashes "A," "B," and "D."

<b>RP</b>	<b>2167</b>	<b>MO13N TO IS44E</b>	<b>(E)</b>	
<b>MO</b>	<b>13</b>		<b>(S)</b>	<b>(SJ)</b>
<b>CST</b>	<b>KANSAS EXPY</b>		<b>(S)</b>	<b>(11.897)</b>
<b>RP</b>	<b>982849</b>	<b>IS44E TO MO13N</b>	<b>(N)</b>	
<b>BRIDGE</b>	<b>A0443</b>	<b>IS 44</b>		
<b>IS</b>	<b>44</b>		<b>(E)</b>	
<b>IS</b>	<b>44</b>		<b>(W)</b>	
<b>RP</b>	<b>982852</b>	<b>MO13N TO IS44W</b>	<b>(W)</b>	
<b>MO</b>	<b>13</b>		<b>(S)</b>	<b>(NJ)</b>
<b>CST</b>	<b>KANSAS EXPY</b>		<b>(S)</b>	<b>(12.003)</b>
<b>RP</b>	<b>3167</b>	<b>IS44W TO MO13N</b>	<b>(N)</b>	
<b>CST</b>	<b>KANSAS EXPY</b>		<b>(N)</b>	<b>(12.021)</b>

**Crash "A":**

Crash "A" is located on Ramp 3167 (Roadway Direction - "N") and can only be measured to the nearest painted gore at the northbound lanes of MO 13 (as shown in the diagram and below).

ON RP 3167		RDWY. DIR. N	DISTANCE FROM 20 Feet Miles	LOCATION <input type="checkbox"/> After <input type="checkbox"/> NA <input checked="" type="checkbox"/> Before <input type="checkbox"/> At	INTERSECTING MO 13
SPEED LIMIT 60	ROADWAY MAINTAINED BY <input checked="" type="checkbox"/> State <input type="checkbox"/> County <input type="checkbox"/> Municipal <input type="checkbox"/> Private Property <input type="checkbox"/> Other				SPEED LIMIT NA
TRAFFICWAY <input checked="" type="checkbox"/> One-Way <input type="checkbox"/> Two-Way, Not Divided <input type="checkbox"/> Two-Way, Divided; Unprotected Median <input type="checkbox"/> Other <input type="checkbox"/> Two-Way, Not Divided, Continuous Center Turn Lane <input type="checkbox"/> Two-Way, Divided; Positive Median Barrier <input type="checkbox"/> Unknown		ROADWAY ALIGNMENT <input type="checkbox"/> Straight <input checked="" type="checkbox"/> Curve <input type="checkbox"/> Unknown (Explain)		ROADWAY PROFILE <input checked="" type="checkbox"/> Level <input type="checkbox"/> Downhill <input type="checkbox"/> Dip <input type="checkbox"/> Uphill <input type="checkbox"/> Hillcrest <input type="checkbox"/> Unknown (Explain)	
INTERSECTION TYPE <input checked="" type="checkbox"/> NA <input type="checkbox"/> PERPENDICULAR <input type="checkbox"/> Cross Intersection (4-Way) <input type="checkbox"/> T-Intersection		ANGLED / SKEWED <input type="checkbox"/> Y-Intersection <input type="checkbox"/> Five or More Legs and Not Circular		ROUNDABOUT / TRAFFIC CIRCLE <input type="checkbox"/> Roundabout <input type="checkbox"/> Other (Explain) <input type="checkbox"/> Other Circular Intersection <input type="checkbox"/> Unknown (Explain)	
Enter Codes		ROADWAY CONDITION 1	LIGHT CONDITION 1	WEATHER / ENVIRON CONDITION 1	ROADWAY SURFACE 1

**Crash "B":**

Crash "B" is located within the intersection of the northbound and southbound lanes of the MO 13 (North Junction). The crash can be shown as occurring On the northbound lanes of MO 13 (shown below) or the southbound lanes of MO 13.

ON MO 13		RDWY. DIR. N	DISTANCE FROM <input checked="" type="checkbox"/> NA Feet Miles	LOCATION <input type="checkbox"/> After <input type="checkbox"/> NA <input checked="" type="checkbox"/> Before <input type="checkbox"/> At	INTERSECTING MO 13 (NJ)
SPEED LIMIT 45	ROADWAY MAINTAINED BY <input checked="" type="checkbox"/> State <input type="checkbox"/> County <input type="checkbox"/> Municipal <input type="checkbox"/> Private Property <input type="checkbox"/> Other				SPEED LIMIT 45
TRAFFICWAY <input type="checkbox"/> One-Way <input type="checkbox"/> Two-Way, Not Divided <input checked="" type="checkbox"/> Two-Way, Divided; Unprotected Median <input type="checkbox"/> Other <input type="checkbox"/> Two-Way, Not Divided, Continuous Center Turn Lane <input type="checkbox"/> Two-Way, Divided; Positive Median Barrier <input type="checkbox"/> Unknown		ROADWAY ALIGNMENT <input type="checkbox"/> Straight <input checked="" type="checkbox"/> Curve <input type="checkbox"/> Unknown (Explain)		ROADWAY PROFILE <input checked="" type="checkbox"/> Level <input type="checkbox"/> Downhill <input type="checkbox"/> Dip <input type="checkbox"/> Uphill <input type="checkbox"/> Hillcrest <input type="checkbox"/> Unknown (Explain)	
INTERSECTION TYPE <input type="checkbox"/> NA <input checked="" type="checkbox"/> PERPENDICULAR <input type="checkbox"/> Cross Intersection (4-Way) <input type="checkbox"/> T-Intersection		ANGLED / SKEWED <input type="checkbox"/> Y-Intersection <input type="checkbox"/> Five or More Legs and Not Circular		ROUNDABOUT / TRAFFIC CIRCLE <input type="checkbox"/> Roundabout <input type="checkbox"/> Other (Explain) <input type="checkbox"/> Other Circular Intersection <input type="checkbox"/> Unknown (Explain)	
Enter Codes		ROADWAY CONDITION 1	LIGHT CONDITION 1	WEATHER / ENVIRON CONDITION 1	ROADWAY SURFACE 1

**Crash "C":**

Crash "C" is located on MO 13 (Roadway Direction - "S") and can be measured to the nearest ramp (as shown in the diagram and below), the beginning of the nearest bridge structure (not shown), the eastbound lanes of IS 44 (not shown), or the intersection of the northbound lanes of MO 13 at the South Junction (not shown).

ON MO 13		RDWY. DIR. S	DISTANCE FROM 20 Feet Miles	LOCATION <input type="checkbox"/> After <input type="checkbox"/> NA <input checked="" type="checkbox"/> Before <input type="checkbox"/> At	INTERSECTING RP 98250
SPEED LIMIT 45	ROADWAY MAINTAINED BY <input checked="" type="checkbox"/> State <input type="checkbox"/> County <input type="checkbox"/> Municipal <input type="checkbox"/> Private Property <input type="checkbox"/> Other				SPEED LIMIT NA
TRAFFICWAY <input type="checkbox"/> One-Way <input type="checkbox"/> Two-Way; Not Divided <input type="checkbox"/> Two-Way; Divided; Unprotected Median <input type="checkbox"/> Other <input type="checkbox"/> Two-Way; Not Divided; Continuous Center Turn Lane <input checked="" type="checkbox"/> Two-Way; Divided; Positive Median Barrier <input type="checkbox"/> Unknown			ROADWAY ALIGNMENT <input checked="" type="checkbox"/> Straight <input type="checkbox"/> Curve <input type="checkbox"/> Unknown (Explain)	ROADWAY PROFILE <input checked="" type="checkbox"/> Level <input type="checkbox"/> Downhill <input type="checkbox"/> Dip <input type="checkbox"/> Uphill <input type="checkbox"/> Hillcrest <input type="checkbox"/> Unknown (Explain)	
INTERSECTION TYPE <input checked="" type="checkbox"/> NA <input type="checkbox"/> Cross Intersection (4-Way) <input type="checkbox"/> T-Intersection			ANGLED / SKEWED <input type="checkbox"/> Y-Intersection <input type="checkbox"/> Five or More Legs and Not Circular	ROUNDABOUT / TRAFFIC CIRCLE <input type="checkbox"/> Roundabout <input type="checkbox"/> Other (Explain) <input type="checkbox"/> Other Circular Intersection <input type="checkbox"/> Unknown (Explain)	Enter Codes
ROADWAY CONDITION			1	ROADWAY SURFACE	1
LIGHT CONDITION			1	WEATHER / ENVIRON CONDITION	1

**Crash "D":**

Crash "D" is located on MO 13 (Roadway Direction - "N") and can be measured to the nearest ramp (as shown in the diagram and below) or the intersection of the southbound lanes of MO 13 at the South Junction (not shown).

ON MO 13		RDWY. DIR. N	DISTANCE FROM 21 Feet Miles	LOCATION <input type="checkbox"/> After <input type="checkbox"/> NA <input checked="" type="checkbox"/> Before <input type="checkbox"/> At	INTERSECTING RP 2167
SPEED LIMIT 45	ROADWAY MAINTAINED BY <input checked="" type="checkbox"/> State <input type="checkbox"/> County <input type="checkbox"/> Municipal <input type="checkbox"/> Private Property <input type="checkbox"/> Other				SPEED LIMIT NA
TRAFFICWAY <input type="checkbox"/> One-Way <input type="checkbox"/> Two-Way; Not Divided <input checked="" type="checkbox"/> Two-Way; Divided; Unprotected Median <input type="checkbox"/> Other <input type="checkbox"/> Two-Way; Not Divided; Continuous Center Turn Lane <input type="checkbox"/> Two-Way; Divided; Positive Median Barrier <input type="checkbox"/> Unknown			ROADWAY ALIGNMENT <input checked="" type="checkbox"/> Straight <input type="checkbox"/> Curve <input type="checkbox"/> Unknown (Explain)	ROADWAY PROFILE <input checked="" type="checkbox"/> Level <input type="checkbox"/> Downhill <input type="checkbox"/> Dip <input type="checkbox"/> Uphill <input type="checkbox"/> Hillcrest <input type="checkbox"/> Unknown (Explain)	
INTERSECTION TYPE <input checked="" type="checkbox"/> NA <input type="checkbox"/> Cross Intersection (4-Way) <input type="checkbox"/> T-Intersection			ANGLED / SKEWED <input type="checkbox"/> Y-Intersection <input type="checkbox"/> Five or More Legs and Not Circular	ROUNDABOUT / TRAFFIC CIRCLE <input type="checkbox"/> Roundabout <input type="checkbox"/> Other (Explain) <input type="checkbox"/> Other Circular Intersection <input type="checkbox"/> Unknown (Explain)	Enter Codes
ROADWAY CONDITION			1	ROADWAY SURFACE	1
LIGHT CONDITION			1	WEATHER / ENVIRON CONDITION	1

**Crash "E":**

Crash "E" is located either on Ramp 2167 or Ramp 982850 (because they overlap at the crash scene) and can only be measured to the nearest painted gore with IS 44 (as shown in the diagram and below).

ON RP 2167		RDWY. DIR. E	DISTANCE FROM 100 Feet Miles	LOCATION <input type="checkbox"/> After <input type="checkbox"/> NA <input checked="" type="checkbox"/> Before <input type="checkbox"/> At	INTERSECTING IS 44
SPEED LIMIT 45	ROADWAY MAINTAINED BY <input checked="" type="checkbox"/> State <input type="checkbox"/> County <input type="checkbox"/> Municipal <input type="checkbox"/> Private Property <input type="checkbox"/> Other				SPEED LIMIT NA
TRAFFICWAY <input checked="" type="checkbox"/> One-Way <input type="checkbox"/> Two-Way; Not Divided <input type="checkbox"/> Two-Way; Divided; Unprotected Median <input type="checkbox"/> Other <input type="checkbox"/> Two-Way; Not Divided; Continuous Center Turn Lane <input type="checkbox"/> Two-Way; Divided; Positive Median Barrier <input type="checkbox"/> Unknown			ROADWAY ALIGNMENT <input checked="" type="checkbox"/> Straight <input type="checkbox"/> Curve <input type="checkbox"/> Unknown (Explain)	ROADWAY PROFILE <input type="checkbox"/> Level <input checked="" type="checkbox"/> Downhill <input type="checkbox"/> Dip <input type="checkbox"/> Uphill <input type="checkbox"/> Hillcrest <input type="checkbox"/> Unknown (Explain)	
INTERSECTION TYPE <input checked="" type="checkbox"/> NA <input type="checkbox"/> Cross Intersection (4-Way) <input type="checkbox"/> T-Intersection			ANGLED / SKEWED <input type="checkbox"/> Y-Intersection <input type="checkbox"/> Five or More Legs and Not Circular	ROUNDABOUT / TRAFFIC CIRCLE <input type="checkbox"/> Roundabout <input type="checkbox"/> Other (Explain) <input type="checkbox"/> Other Circular Intersection <input type="checkbox"/> Unknown (Explain)	Enter Codes
ROADWAY CONDITION			1	ROADWAY SURFACE	1
LIGHT CONDITION			1	WEATHER / ENVIRON CONDITION	1

## Directional or Combination Interchange

Crashes are located in and around a directional interchange in the same method as any other interchange. Examples are provided due to the unique characteristics of this type of interchange. This also provides examples of locating crashes on overlapping ramps. In the case of overlapping ramps, it may be necessary to examine more than one roadway listing from the [MoDOT Interactive Mapping Tool](#) in order to determine the numbers of each ramp once they separate.

### Example #8

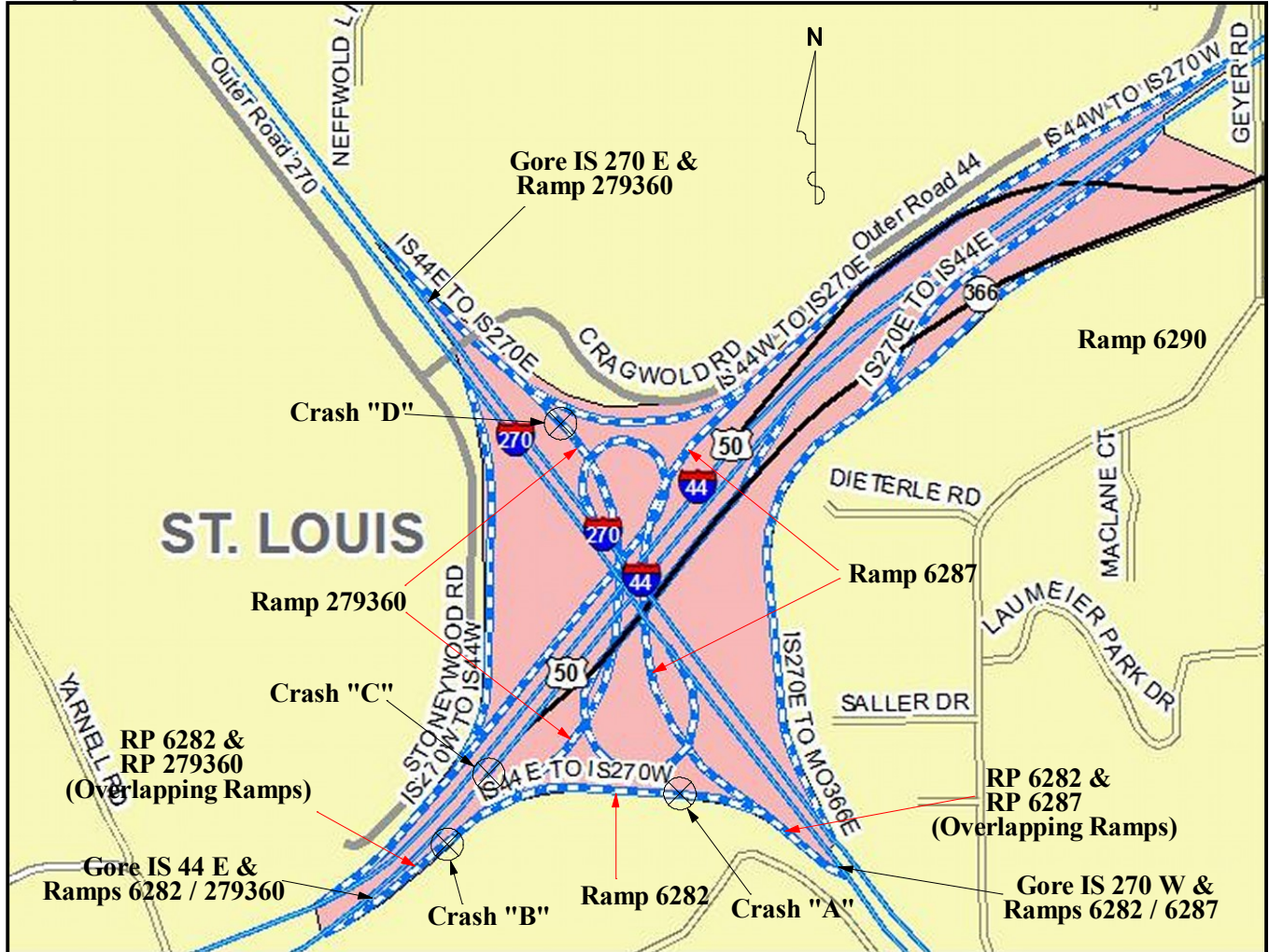

The fact that the crashes occurred within the interchange is immaterial as far as completion of the crash report is concerned. Crashes "A," "B," and "D" are located on the appropriate ramp and measured to the nearest gore with IS 44 or IS 270. Crash "C" is located on IS 44 and is measured to the nearest ramp, roadway, ERM, or to IS 270.



An example from the [MoDOT Interactive Mapping Tool](#) showing IS 44 E is as follows and is used in the following examples.

<u>RP</u>	<u>6282</u>	IS44E TO IS270W	<u>(W)</u>	
<u>RP</u>	<u>279360</u>	IS44E TO IS270E	<u>(E)</u>	<u>(WJ)</u>
<u>MO</u>	<u>366</u>		<u>(E)</u>	
<u>RP</u>	<u>279360</u>	IS44E TO IS270E	<u>(E)</u>	<u>(EJ)</u>
<u>IS</u>	<u>270</u>		<u>(W)</u>	
<u>IS</u>	<u>270</u>		<u>(E)</u>	
<u>RP</u>	<u>6287</u>	IS44W TO IS270W	<u>(W)</u>	
<u>RP</u>	<u>6292</u>	IS270W TO IS44E	<u>(E)</u>	
<u>MO</u>	<u>366</u>		<u>(W)</u>	
<u>RP</u>	<u>6290</u>	IS270E TO IS44E	<u>(E)</u>	

**Crash "A":**

Crash "A" is located On Ramp 6282 (Roadway Direction either "E" or "W") and can be measured back to the gore with IS 44 E or to the gore with IS 270 W (shown below). In the case of overlapping ramps, it may be necessary to examine more than one listing from the MoDOT Interactive Mapping Tool in order to determine the ramp number once overlapping ramps separate. In this case, Ramps 6282 and 279360 overlap for some distance and then separate prior to the location of Crash "A." Examination of the listing for either IS 270 E or IS 270 W will assist in determining that the crash occurred on Ramp 6282.

ON RP 6282		RDWY. DIR. W	DISTANCE FROM <input type="checkbox"/> NA 0.2 Miles	LOCATION <input type="checkbox"/> After <input type="checkbox"/> NA <input checked="" type="checkbox"/> Before <input type="checkbox"/> At	INTERSECTING IS 270 SPEED LIMIT INT. DIR. GEO - CODE NA W NA
SPEED LIMIT 60	ROADWAY MAINTAINED BY <input checked="" type="checkbox"/> State <input type="checkbox"/> County <input type="checkbox"/> Municipal <input type="checkbox"/> Private Property <input type="checkbox"/> Other				
TRAFFICWAY <input checked="" type="checkbox"/> One-Way <input type="checkbox"/> Two-Way, Not Divided <input type="checkbox"/> Two-Way, Divided, Unprotected Median <input type="checkbox"/> Other <input type="checkbox"/> Two-Way, Not Divided, Continuous Center Turn Lane <input type="checkbox"/> Two-Way, Divided, Positive Median Barrier <input type="checkbox"/> Unknown			ROADWAY ALIGNMENT <input type="checkbox"/> Straight <input checked="" type="checkbox"/> Curve <input type="checkbox"/> Unknown (Explain)		ROADWAY PROFILE <input checked="" type="checkbox"/> Level <input type="checkbox"/> Downhill <input type="checkbox"/> Dip <input type="checkbox"/> Uphill <input type="checkbox"/> Hillcrest <input type="checkbox"/> Unknown (Explain)
INTERSECTION TYPE PERPENDICULAR ANGLLED / SKEWED ROUNDABOUT / TRAFFIC CIRCLE <input checked="" type="checkbox"/> NA <input type="checkbox"/> Cross Intersection (4-Way) <input type="checkbox"/> Y-Intersection <input type="checkbox"/> Roundabout <input type="checkbox"/> Other (Explain) <input type="checkbox"/> T-Intersection <input type="checkbox"/> Five or More Legs and Not Circular <input type="checkbox"/> Other Circular Intersection <input type="checkbox"/> Unknown (Explain)		Enter Codes		ROADWAY CONDITION 1	ROADWAY SURFACE 1
LIGHT CONDITION 1		WEATHER / ENVIRON CONDITION 1			

**Crash "B":**

Ramps 6282 and 279360 overlap at the location of Crash "B." Consequently, Crash "B" is located On Ramp 6282 or Ramp 279360 (Roadway Direction - "E"). If shown on Ramp 6282, it can be measured back to the gore with IS 44 E (shown below) or to the gore with IS 270 W. If shown on Ramp 279360, it can be measured back to the gore with IS 44 E or to the gore with IS 270 E (shown below).

ON RP 6282		RDWY. DIR. W	DISTANCE FROM <input type="checkbox"/> NA 0.1 Miles	LOCATION <input checked="" type="checkbox"/> After <input type="checkbox"/> NA <input type="checkbox"/> Before <input type="checkbox"/> At	INTERSECTING IS 44 SPEED LIMIT INT. DIR. GEO - CODE NA E NA
SPEED LIMIT 60	ROADWAY MAINTAINED BY <input checked="" type="checkbox"/> State <input type="checkbox"/> County <input type="checkbox"/> Municipal <input type="checkbox"/> Private Property <input type="checkbox"/> Other				
TRAFFICWAY <input checked="" type="checkbox"/> One-Way <input type="checkbox"/> Two-Way, Not Divided <input type="checkbox"/> Two-Way, Divided, Unprotected Median <input type="checkbox"/> Other <input type="checkbox"/> Two-Way, Not Divided, Continuous Center Turn Lane <input type="checkbox"/> Two-Way, Divided, Positive Median Barrier <input type="checkbox"/> Unknown			ROADWAY ALIGNMENT <input type="checkbox"/> Straight <input checked="" type="checkbox"/> Curve <input type="checkbox"/> Unknown (Explain)		ROADWAY PROFILE <input checked="" type="checkbox"/> Level <input type="checkbox"/> Downhill <input type="checkbox"/> Dip <input type="checkbox"/> Uphill <input type="checkbox"/> Hillcrest <input type="checkbox"/> Unknown (Explain)
INTERSECTION TYPE PERPENDICULAR ANGLLED / SKEWED ROUNDABOUT / TRAFFIC CIRCLE <input checked="" type="checkbox"/> NA <input type="checkbox"/> Cross Intersection (4-Way) <input type="checkbox"/> Y-Intersection <input type="checkbox"/> Roundabout <input type="checkbox"/> Other (Explain) <input type="checkbox"/> T-Intersection <input type="checkbox"/> Five or More Legs and Not Circular <input type="checkbox"/> Other Circular Intersection <input type="checkbox"/> Unknown (Explain)		Enter Codes		ROADWAY CONDITION 1	ROADWAY SURFACE 1
LIGHT CONDITION 1		WEATHER / ENVIRON CONDITION 1			

ON RP 279360		RDWY. DIR. E	DISTANCE FROM <input type="checkbox"/> NA 0.5 Miles	LOCATION <input checked="" type="checkbox"/> After <input type="checkbox"/> NA <input type="checkbox"/> Before <input type="checkbox"/> At	INTERSECTING IS 270 SPEED LIMIT INT. DIR. GEO - CODE NA E NA
SPEED LIMIT 60	ROADWAY MAINTAINED BY <input checked="" type="checkbox"/> State <input type="checkbox"/> County <input type="checkbox"/> Municipal <input type="checkbox"/> Private Property <input type="checkbox"/> Other				
TRAFFICWAY <input checked="" type="checkbox"/> One-Way <input type="checkbox"/> Two-Way, Not Divided <input type="checkbox"/> Two-Way, Divided, Unprotected Median <input type="checkbox"/> Other <input type="checkbox"/> Two-Way, Not Divided, Continuous Center Turn Lane <input type="checkbox"/> Two-Way, Divided, Positive Median Barrier <input type="checkbox"/> Unknown			ROADWAY ALIGNMENT <input type="checkbox"/> Straight <input checked="" type="checkbox"/> Curve <input type="checkbox"/> Unknown (Explain)		ROADWAY PROFILE <input checked="" type="checkbox"/> Level <input type="checkbox"/> Downhill <input type="checkbox"/> Dip <input type="checkbox"/> Uphill <input type="checkbox"/> Hillcrest <input type="checkbox"/> Unknown (Explain)
INTERSECTION TYPE PERPENDICULAR ANGLLED / SKEWED ROUNDABOUT / TRAFFIC CIRCLE <input checked="" type="checkbox"/> NA <input type="checkbox"/> Cross Intersection (4-Way) <input type="checkbox"/> Y-Intersection <input type="checkbox"/> Roundabout <input type="checkbox"/> Other (Explain) <input type="checkbox"/> T-Intersection <input type="checkbox"/> Five or More Legs and Not Circular <input type="checkbox"/> Other Circular Intersection <input type="checkbox"/> Unknown (Explain)		Enter Codes		ROADWAY CONDITION 1	ROADWAY SURFACE 1
LIGHT CONDITION 1		WEATHER / ENVIRON CONDITION 1			

**Crash "C":**

Crash "C" is located On IS 44 (Roadway Direction - "E") and can be measured back to the gore with Ramp 6282 (shown below) or the west junction (WJ) of Ramp 279360 since the two ramps overlap at this location (shown below), to the gore with MO 366, to the east junction (EJ) with Ramp 279360 (where the ramp goes over IS 44 E), to IS 270 W, or to the nearest ERM.

ON IS 44		RDWY. DIR. E	DISTANCE FROM <input type="checkbox"/> NA Feet 0.2 Miles	LOCATION <input checked="" type="checkbox"/> After <input type="checkbox"/> NA <input type="checkbox"/> Before <input type="checkbox"/> At	INTERSECTING RP 6282	SPEED LIMIT NA	INT. DIR. W	GEO - CODE NA
SPEED LIMIT 60	ROAD MAINTAINED BY <input checked="" type="checkbox"/> State <input type="checkbox"/> County <input type="checkbox"/> Municipal <input type="checkbox"/> Private Property <input type="checkbox"/> Other							

ON IS 44		RDWY. DIR. E	DISTANCE FROM <input type="checkbox"/> NA Feet 0.2 Miles	LOCATION <input checked="" type="checkbox"/> After <input type="checkbox"/> NA <input type="checkbox"/> Before <input type="checkbox"/> At	INTERSECTING RP 279360 (WJ)	SPEED LIMIT NA	INT. DIR. E	GEO - CODE NA
SPEED LIMIT 60	ROAD MAINTAINED BY <input checked="" type="checkbox"/> State <input type="checkbox"/> County <input type="checkbox"/> Municipal <input type="checkbox"/> Private Property <input type="checkbox"/> Other							

**Crash "D":**

Crash "D" is located On Ramp 279360 (Roadway Direction - "E") and can be measured back to the gore with IS 44 E or to the gore with IS 270 E.

ON RP 279360		RDWY. DIR. E	DISTANCE FROM <input type="checkbox"/> NA Feet 0.5 Miles	LOCATION <input checked="" type="checkbox"/> After <input type="checkbox"/> NA <input type="checkbox"/> Before <input type="checkbox"/> At	INTERSECTING IS 44	SPEED LIMIT NA	INT. DIR. E	GEO - CODE NA
SPEED LIMIT 60	ROAD MAINTAINED BY <input checked="" type="checkbox"/> State <input type="checkbox"/> County <input type="checkbox"/> Municipal <input type="checkbox"/> Private Property <input type="checkbox"/> Other							

ON RP 279360		RDWY. DIR. E	DISTANCE FROM <input type="checkbox"/> NA Feet 0.1 Miles	LOCATION <input type="checkbox"/> After <input type="checkbox"/> NA <input checked="" type="checkbox"/> Before <input type="checkbox"/> At	INTERSECTING IS 270	SPEED LIMIT NA	INT. DIR. E	GEO - CODE NA
SPEED LIMIT 60	ROAD MAINTAINED BY <input checked="" type="checkbox"/> State <input type="checkbox"/> County <input type="checkbox"/> Municipal <input type="checkbox"/> Private Property <input type="checkbox"/> Other							

## JUNCTIONS

When two roadways with the same name intersect more than once within a county, a designation showing which junction is being referenced must be entered in the "Intersecting" field after the roadway name. The appropriate letter or numerical value as found in the [MoDOT Interactive Mapping Tool](#) must be used.

### Two or three intersections:

If two or three intersections, use the appropriate letters from the [MoDOT Interactive Mapping Tool](#). Use (NJ) - North Junction, (SJ) - South Junction, (EJ) - East Junction, (WJ) - West Junction, (MJ) - Middle Junction to indicate the junction being referenced.

<b>RT B N</b>	(7370)
BEGIN AUDRAIN	COUNTY
US 54	(E)
CRD 412	(E)
CST CHURCH ST	(E)
CST MAIN ST	(E)
CST SECOND ST	(E)
CST FIFTH ST	(E)
CST SIXTH ST	(E)
RT KK	(E) (SJ)
RT KK	(E) (NJ)
CRD 9446	(E)
CRD 448	(E)
BRIDGE T0208 W LICK CR	
RT J	(E) (SJ)
BRIDGE T0206 W LICK CR	
BRIDGE T0207 BR W LICK CR	
RT J	(E) (NJ)
CRD 472	(E)
CRD 480	(E)
BRIDGE T0205 BR LICK CR	

In the example above RT B and RT KK overlap one another between the junctions.

### Crash "A":

Crash "A" is located in the intersection of RT B and the north junction with RT KK. The crash can be located On RT B (Roadway Direction - "N") At RT KK (NJ) (as shown in the example) or On RT KK (Roadway Direction - "E") At RT B (NJ) (Not shown).

ON	RDWY. DIR.	DISTANCE FROM	LOCATION	INTERSECTING
RT B	N	<input checked="" type="checkbox"/> NA	<input type="checkbox"/> After <input type="checkbox"/> NA	RT KK (NJ)
SPEED LIMIT	ROAD MAINTAINED BY	Feet	<input type="checkbox"/> Before	SPEED LIMIT
55	<input checked="" type="checkbox"/> State <input type="checkbox"/> County <input type="checkbox"/> Municipal <input type="checkbox"/> Private Property <input type="checkbox"/> Other	Miles	<input checked="" type="checkbox"/> At	55
				INT. DIR.
				E
				GEO — CODE
				NA

### Crash "B":

Crash "B" can be located On RT B (Roadway Direction - "S"), 0.1 Mile Before the south junction with RT KK (as shown in the example) or On RT KK (Roadway Direction - "W"), 0.1 Mile Before the south junction with RT B (not shown).

ON	RDWY. DIR.	DISTANCE FROM	LOCATION	INTERSECTING
RT B	S	<input type="checkbox"/> NA	<input type="checkbox"/> After <input type="checkbox"/> NA	RT KK (SJ)
SPEED LIMIT	ROAD MAINTAINED BY	Feet	<input checked="" type="checkbox"/> Before	SPEED LIMIT
55	<input checked="" type="checkbox"/> State <input type="checkbox"/> County <input type="checkbox"/> Municipal <input type="checkbox"/> Private Property <input type="checkbox"/> Other	0.1 Miles	<input type="checkbox"/> At	55
				INT. DIR.
				W
				GEO — CODE
				NA

**Four or More Intersections:**

If four or more intersections, the [MoDOT Interactive Mapping Tool](#) MUST be used to obtain the appropriate numerical value assigned to the specific junction.

MO 21 N	(17)			BRIDGE A6487	RT BB	
WASHINGTON/JEFFERSON COUNTY LINE				RT BB		(S)
BEGIN JEFFERSON	COUNTY			BEGIN HILLSBORO		CITY LIMITS
CRD BRITTON RD	(E)	(SJ)		BEGIN HILLSBORO		CITY LIMITS
CRD BRITTON RD	(E)	(NJ)		RT A		(E)
CRD PERKINS RD	(E)			BRIDGE A6779	SANDY CR	
CRD DODSON LN	(S)			BRIDGE A6483	CRD HAYDEN RD	
CRD BIG RIVER HEIGHTS RD	(E)			CRD HAYDEN RD		(E)
CRD GRASSY LN	(E)			CRD GLADE CHAPEL RD		(E)
CRD MOTHERSHEAD RD	(E)			CRD OLD HWY 21		(S) (20.901)
CRD VINELAND RD	(E)			BRIDGE A6056	CRD KLABLE RD	
BRIDGE L0013	WHITEHEAD CR			CRD KLABLE RD		(E)
CRD BRIGGS DR	(S)			CRD OLD HWY 21		(S) (23.488)
CRD LEMBECK LAKE RD	(E)			BRIDGE A2945	CRD HEADS CREEK RD	
CST VINELAND SCHOOL RD	(E)			CRD HEADS CREEK RD		(S)
CRD YELLOW ROCK RD	(E)			BRIDGE A5529	RT M	
CRD COLLEGE HEIGHTS RD	(E)			RT M		(E)
BEGIN DE SOTO	CITY LIMITS			RT M		(W)
BRIDGE L0012	TANYARD BR			CRD WEST FOUR RIDGE RD		(S)
CST AMVETS DR	(E)			BRIDGE A2942	CRD OLD HWY 21	
BEGIN DE SOTO	CITY LIMITS			CRD OLD HWY 21		(S) (28.669)
RT H	(E)			BRIDGE A2958	ROCK CR	
CST JEFFERSON DR	(S)	(SJ)		BRIDGE A2956	CRD OLD HWY 21	
CST JEFFERSON DR	(S)	(NJ)		CRD OLD HWY 21		(S) (30.267)
CST NEW BOYD STREET RD	(E)			CRD SWALLER RD		(S)
CST BOYD ST	(E)			CRD BLECHA RD		(S)
CRD UNKNOWN	(S)			CRD ROCK CREEK RD		(E)
PVT WALMART	(E)			CRD OLD HWY 21		(S) (31.446)
BEGIN DE SOTO	CITY LIMITS			BRIDGE A3098	CRD LONEDELL RD	
RT	(E)			CRD LONEDELL RD		(E)
				W OR 21		(S)

For example, there are five junctions of CRD Old Hwy 21 with MO 21 in Jefferson County. A crash occurring within the intersection at the first junction listed would be shown in *Section 2 - Location* as follows:

ON	RDWY. DIR.	DISTANCE FROM	LOCATION	INTERSECTING
MO 21	N	<input checked="" type="checkbox"/> NA	<input type="checkbox"/> After <input type="checkbox"/> NA	CRD Old Hwy 21 (20.901)
SPEED LIMIT	ROAD MAINTAINED BY	Feet	<input type="checkbox"/> Before	SPEED LIMIT
65	<input checked="" type="checkbox"/> State <input type="checkbox"/> County <input type="checkbox"/> Municipal <input type="checkbox"/> Private Property <input type="checkbox"/> Other	Miles	<input checked="" type="checkbox"/> At	45
				INT. DIR.
				S
				GEO - CODE
				NA

## BRIDGES

When locating crashes on or referenced to a bridge, the bridge number in the [MoDOT Interactive Mapping Tool](#) identifies the beginning of the bridge structure in conjunction with the direction of the roadway. Therefore, crashes must be measured to the BEGINNING (not the middle or end) of a bridge structure as it relates to the roadway direction entered in the "Rdwy. Dir." field. The bridge structure does not include any attached guardrail or crash barriers.

### Example #1:

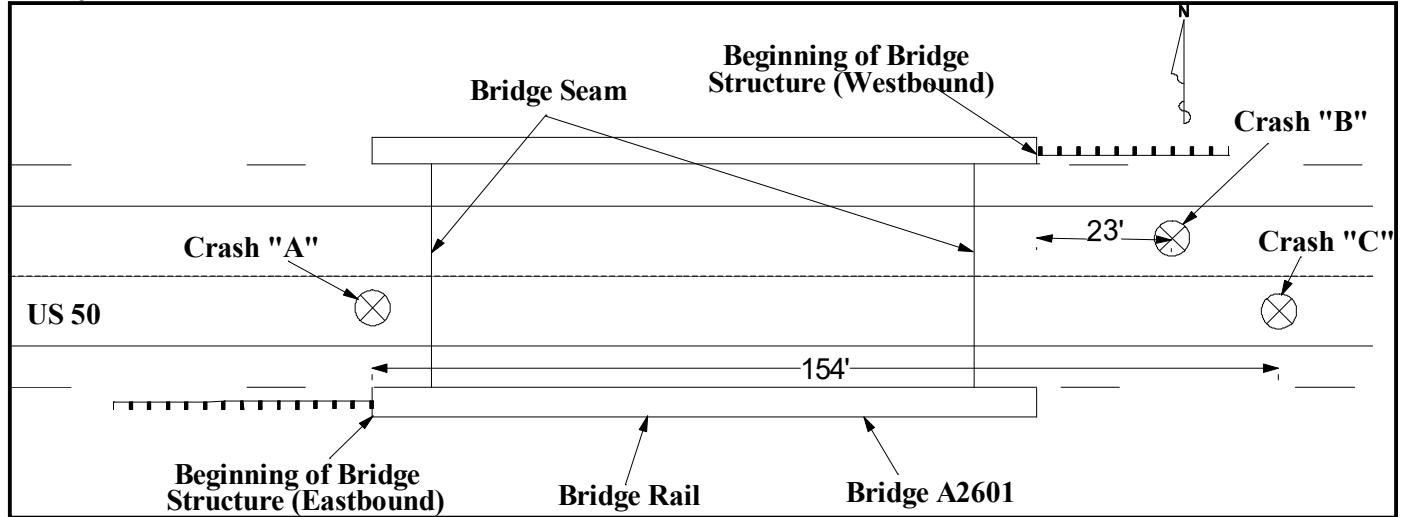

#### Crash "A":

Crash "A" occurred at the beginning of the bridge structure in the eastbound lane. The crash is located On US 50 (Roadway Direction - "E"), At BRIDGE A2601. "NA" is entered in the "Int Dir" field.

ON US 50		RDWY. DIR. E	DISTANCE FROM <input checked="" type="checkbox"/> NA Feet Miles	LOCATION <input type="checkbox"/> After <input type="checkbox"/> NA <input type="checkbox"/> Before <input checked="" type="checkbox"/> At	INTERSECTING BRIDGE A2601	SPEED LIMIT NA	INT. DIR. NA	GEO - CODE NA
SPEED LIMIT 60	ROAD MAINTAINED BY <input checked="" type="checkbox"/> State <input type="checkbox"/> County <input type="checkbox"/> Municipal <input type="checkbox"/> Private Property <input type="checkbox"/> Other							

#### Crash "B":

Crash "B" occurred in the westbound lane prior to the bridge structure. The crash is located On US 50 (Roadway Direction - "W"), 23 Feet Before BRIDGE A2601. "NA" is entered in the "Int Dir" field.

ON US 50		RDWY. DIR. W	DISTANCE FROM 23 <input type="checkbox"/> NA Feet Miles	LOCATION <input type="checkbox"/> After <input type="checkbox"/> NA <input checked="" type="checkbox"/> Before <input type="checkbox"/> At	INTERSECTING BRIDGE A2601	SPEED LIMIT NA	INT. DIR. NA	GEO - CODE NA
SPEED LIMIT 60	ROAD MAINTAINED BY <input checked="" type="checkbox"/> State <input type="checkbox"/> County <input type="checkbox"/> Municipal <input type="checkbox"/> Private Property <input type="checkbox"/> Other							

#### Crash "C":

Crash "C" occurred in the eastbound lane after the bridge structure. The crash is located On US 50 (Roadway Direction - "E"), 154 Feet After BRIDGE A2601. "NA" is entered in the "Int. Dir" field.

ON US 50		RDWY. DIR. E	DISTANCE FROM 154 <input type="checkbox"/> NA Feet Miles	LOCATION <input checked="" type="checkbox"/> After <input type="checkbox"/> NA <input type="checkbox"/> Before <input type="checkbox"/> At	INTERSECTING BRIDGE A2601	SPEED LIMIT NA	INT. DIR. NA	GEO - CODE NA
SPEED LIMIT 60	ROAD MAINTAINED BY <input checked="" type="checkbox"/> State <input type="checkbox"/> County <input type="checkbox"/> Municipal <input type="checkbox"/> Private Property <input type="checkbox"/> Other							

**REST AREAS and WEIGH STATIONS**

The method for locating crashes on weight station or rest area lots is the same. The crash location is measured to the nearest entrance into the lot or the nearest exit from the lot.

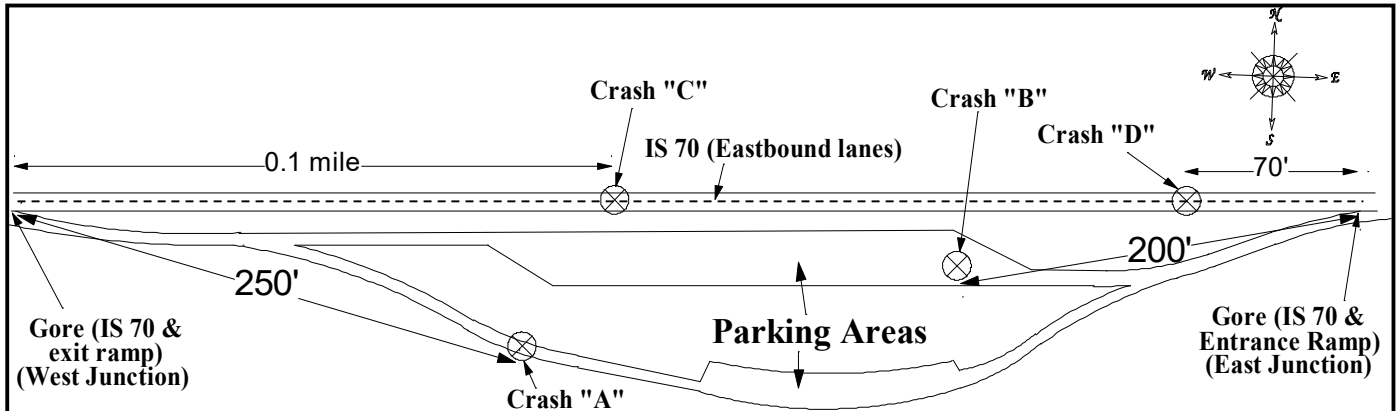

**IS 70 E (Montgomery County)**

<u>RT</u>	<u>N</u>		<u>(S)</u>
<u>RA</u>	<u>IS70E MINEOLA</u>		<u>(E)</u> <u>(WJ)</u>
<u>RA</u>	<u>IS70E MINEOLA</u>		<u>(E)</u> <u>(EJ)</u>
<u>BRIDGE</u>	<u>L0395</u>	LOUTRE RVR OVRFL	

**IS 70 E (Lafayette County)**

<u>BRIDGE</u>	<u>A0094</u>	WITCHET CR	
<u>WS</u>	<u>IS70E MAYVIEW</u>		<u>(E)</u> <u>(WJ)</u>
<u>WS</u>	<u>IS70E MAYVIEW</u>		<u>(E)</u> <u>(EJ)</u>
<u>BRIDGE</u>	<u>A0077</u>	CRD UNDERPASS RD	

**Crash "A":**

Assume Crash "A" occurred in the Mineola rest area on Interstate 70 in Montgomery County. Crash "A" is located On RA IS70E Mineola (Roadway Direction - "E"), 250 Feet After IS 70 (WJ) (shown below). The name of the rest area was obtained from the [MoDOT Interactive Mapping Tool](#) (shown above).

ON RA IS70E Mineola		RDY. DIR. E	DISTANCE FROM 250 Feet NA	LOCATION <input checked="" type="checkbox"/> After <input type="checkbox"/> Before <input type="checkbox"/> At <input type="checkbox"/> NA	INTERSECTING IS 70 (WJ)
SPEED LIMIT NA	ROADWAY MAINTAINED BY <input checked="" type="checkbox"/> State <input type="checkbox"/> County <input type="checkbox"/> Municipal <input type="checkbox"/> Private Property <input type="checkbox"/> Other				SPEED LIMIT NA
TRAFFICWAY <input checked="" type="checkbox"/> One-Way <input type="checkbox"/> Two-Way, Not Divided <input type="checkbox"/> Two-Way, Divided, Unprotected Median <input type="checkbox"/> Other <input type="checkbox"/> Two-Way, Not Divided, Continuous Center Turn Lane <input type="checkbox"/> Two-Way, Divided, Positive Median Barrier <input type="checkbox"/> Unknown		ROADWAY ALIGNMENT <input checked="" type="checkbox"/> Straight <input type="checkbox"/> Curve <input type="checkbox"/> Unknown (Explain)		ROADWAY PROFILE <input type="checkbox"/> Level <input checked="" type="checkbox"/> Downhill <input type="checkbox"/> Dip <input type="checkbox"/> Uphill <input type="checkbox"/> Hillcrest <input type="checkbox"/> Unknown (Explain)	
INTERSECTION TYPE <input checked="" type="checkbox"/> NA <input type="checkbox"/> Cross Intersection (4-Way) <input type="checkbox"/> T-Intersection		ANGLED / SKEWED <input type="checkbox"/> Y-Intersection <input type="checkbox"/> Five or More Legs and Not Circular		ROUNDABOUT / TRAFFIC CIRCLE <input type="checkbox"/> Roundabout <input type="checkbox"/> Other Circular Intersection <input type="checkbox"/> Other (Explain) <input type="checkbox"/> Unknown (Explain)	
ROADWAY CONDITION LIGHT CONDITION 1		ROADWAY SURFACE 2		WEATHER / ENVIRON CONDITION 1	

**Crash "B":**

Assume Crash "B" occurred on the Mayview weigh station lot on Interstate 70 in Lafayette County. Crash "B" is located On WS IS70E Mayview (Roadway Direction - "E"), 200 Feet Before IS 70 (EJ) (shown below). The name of the weigh station was obtained from the [MoDOT Interactive Mapping Tool](#) (shown above).

ON WS IS70E Mayview		RDWY. DIR. E	DISTANCE FROM 200 <input type="checkbox"/> NA Feet	LOCATION <input type="checkbox"/> After <input type="checkbox"/> NA <input checked="" type="checkbox"/> Before	INTERSECTING IS 70 (EJ)
SPEED LIMIT NA	ROADWAY MAINTAINED BY <input checked="" type="checkbox"/> State <input type="checkbox"/> County <input type="checkbox"/> Municipal <input type="checkbox"/> Private Property <input type="checkbox"/> Other		<input type="checkbox"/> NA Miles	<input type="checkbox"/> At	SPEED LIMIT NA
TRAFFICWAY <input checked="" type="checkbox"/> One-Way <input type="checkbox"/> Two-Way, Not Divided <input type="checkbox"/> Two-Way; Divided; Unprotected Median <input type="checkbox"/> Other <input type="checkbox"/> Two-Way; Not Divided; Continuous Center Turn Lane <input type="checkbox"/> Two-Way; Divided; Positive Median Barrier <input type="checkbox"/> Unknown			ROADWAY ALIGNMENT <input checked="" type="checkbox"/> Straight <input type="checkbox"/> Curve <input type="checkbox"/> Unknown (Explain)		ROADWAY PROFILE <input checked="" type="checkbox"/> Level <input type="checkbox"/> Downhill <input type="checkbox"/> Dip <input type="checkbox"/> Uphill <input type="checkbox"/> Hillcrest <input type="checkbox"/> Unknown (Explain)
INTERSECTION TYPE <input checked="" type="checkbox"/> NA <input type="checkbox"/> Cross Intersection (4-Way) <input type="checkbox"/> Y-Intersection <input type="checkbox"/> T-Intersection			ANGLED / SKEWED <input type="checkbox"/> Roundabout <input type="checkbox"/> Other (Explain)		ROADWAY CONDITION 1
PERPENDICULAR <input type="checkbox"/> Cross Intersection (4-Way) <input type="checkbox"/> Y-Intersection <input type="checkbox"/> T-Intersection			ROUNDABOUT / TRAFFIC CIRCLE <input type="checkbox"/> Roundabout <input type="checkbox"/> Other (Explain)		WEATHER / ENVIRON CONDITION 1
			Enter Codes		ROADWAY SURFACE 1

**Crash "C":**

Assume Crash "C" occurred adjacent to the Mineola rest area on Interstate 70 in Montgomery County. Crash "C" is located On IS 70 (Roadway Direction - "E"), 0.1 Mile After RA IS70E Mineola (WJ) (shown below). The name of the rest area was obtained from the [MoDOT Interactive Mapping Tool](#) (shown above).

ON IS 70		RDWY. DIR. E	DISTANCE FROM <input type="checkbox"/> NA 0.1 Miles	LOCATION <input checked="" type="checkbox"/> After <input type="checkbox"/> NA <input type="checkbox"/> Before	INTERSECTING RA IS70E Mineola (WJ)
SPEED LIMIT 70	ROAD MAINTAINED BY <input checked="" type="checkbox"/> State <input type="checkbox"/> County <input type="checkbox"/> Municipal <input type="checkbox"/> Private Property <input type="checkbox"/> Other		<input type="checkbox"/> NA Miles	<input type="checkbox"/> At	SPEED LIMIT NA
					INT. DIR. E
					GEO - CODE NA

**Crash "D":**

Assume Crash "D" occurred adjacent to the Mayview weigh station lot on Interstate 70 in Lafayette County. Crash "D" is located On IS 70 (Roadway Direction - "E"), 70 Feet Before WS IS70E Mayview (EJ) (shown below). The name of the weigh station was obtained from the [MoDOT Interactive Mapping Tool](#) (shown above).

ON IS 70		RDWY. DIR. E	DISTANCE FROM 70 <input type="checkbox"/> NA Feet	LOCATION <input type="checkbox"/> After <input type="checkbox"/> NA <input checked="" type="checkbox"/> Before	INTERSECTING WS IS70E Mayview (EJ)
SPEED LIMIT 70	ROAD MAINTAINED BY <input checked="" type="checkbox"/> State <input type="checkbox"/> County <input type="checkbox"/> Municipal <input type="checkbox"/> Private Property <input type="checkbox"/> Other		<input type="checkbox"/> NA Miles	<input type="checkbox"/> At	SPEED LIMIT NA
					INT. DIR. E
					GEO - CODE NA

## REVERSIBLE LANES

A reversible lane or roadway is one in which traffic may travel in either direction, depending on certain conditions. As of the publication of this preparation manual, the only reversible in Missouri is on IS-70 in the City of St. Louis. The information from the [MoDOT Interactive Mapping Tool](#) is shown below. The “Roadway Direction” on a crash occurring on the reversible will depend on the direction traffic was flowing at the time of the crash.

RV 70 W		(7836)	
IS	70	(W)	(EJ)
CST	BROADWAY	(S)	
CST	CASS AVE	(E)	
CST	N 7TH BLVD	(S)	
CST	HOWARD ST	(E)	
CST	9TH ST	(S)	
CST	MADISON ST	(E)	
PED	NORTH MARKET PL OVERPASS	(E)	
CST	ST LOUIS AVE	(E)	
CST	BRANCH ST	(E)	
MO	115	(S)	
CST	MC KINLEY BRG	(E)	
CST	ANGELICA ST	(E)	
CST	GRAND AVE	(E)	
CST	ADELAIDE AVE	(E)	
CST	CARRIE AVE	(E)	
CST	TAYLOR AVE	(E)	
CST	WEST FLORISSANT AVE	(S)	
CST	SHREVE AVE	(S)	
CST	KINGSHIGHWAY BLVD	(S)	
CST	UNION BLVD	(S)	
IS	70	(W)	(WJ)

RV 70 E		(7835)	
IS	70	(E)	(WJ)
CST	UNION BLVD	(S)	
CST	KINGSHIGHWAY BLVD	(S)	
CST	SHREVE AVE	(S)	
CST	WEST FLORISSANT AVE	(S)	
CST	TAYLOR AVE	(E)	
CST	CARRIE AVE	(E)	
CST	ADELAIDE AVE	(E)	
CST	GRAND AVE	(E)	
CST	ANGELICA ST	(E)	
CST	MC KINLEY BRG	(E)	
MO	115	(S)	
CST	BRANCH ST	(E)	
CST	ST LOUIS AVE	(E)	
PED	NORTH MARKET PL OVERPASS	(E)	
CST	MADISON ST	(E)	
CST	9TH ST	(S)	
CST	HOWARD ST	(E)	
CST	N 7TH BLVD	(S)	
CST	CASS AVE	(E)	
CST	BROADWAY	(S)	
IS	70	(E)	(EJ)

A crash that occurred on the reversible when traffic was flowing East, 0.23 Mile After Kingshighway Boulevard would be shown in *Section 2 - Location* as follows:

ON RV 70		RDWY. DIR. E	DISTANCE FROM <input type="checkbox"/> NA 0.23 Miles	LOCATION <input checked="" type="checkbox"/> After <input type="checkbox"/> NA <input type="checkbox"/> Before <input type="checkbox"/> At	INTERSECTING CST Kingshighway BLVD
SPEED LIMIT 60	ROADWAY MAINTAINED BY <input checked="" type="checkbox"/> State <input type="checkbox"/> County <input type="checkbox"/> Municipal <input type="checkbox"/> Private Property <input type="checkbox"/> Other	Feet		SPEED LIMIT INT. DIR. GEO — CODE NA S NA	
TRAFFICWAY <input checked="" type="checkbox"/> One-Way <input type="checkbox"/> Two-Way, Not Divided <input type="checkbox"/> Two-Way; Divided, Unprotected Median <input type="checkbox"/> Other <input type="checkbox"/> Two-Way; Not Divided, Continuous Center Turn Lane <input type="checkbox"/> Two-Way; Divided, Positive Median Barrier <input type="checkbox"/> Unknown			ROADWAY ALIGNMENT <input checked="" type="checkbox"/> Straight <input type="checkbox"/> Curve <input type="checkbox"/> Unknown (Explain)	ROADWAY PROFILE <input checked="" type="checkbox"/> Level <input type="checkbox"/> Downhill <input type="checkbox"/> Dip <input type="checkbox"/> Uphill <input type="checkbox"/> Hillcrest <input type="checkbox"/> Unknown (Explain)	
INTERSECTION TYPE <input checked="" type="checkbox"/> NA <input type="checkbox"/> Cross Intersection (4-Way) <input type="checkbox"/> T-Intersection		ANGLED / SKEWED <input type="checkbox"/> Y-Intersection <input type="checkbox"/> Five or More Legs and Not Circular		ROUNDABOUT / TRAFFIC CIRCLE <input type="checkbox"/> Roundabout <input type="checkbox"/> Other (Explain) <input type="checkbox"/> Other Circular Intersection <input type="checkbox"/> Unknown (Explain)	
Enter Codes		ROADWAY CONDITION LIGHT CONDITION 1	1	ROADWAY SURFACE 1	
		WEATHER / ENVIRON CONDITION			



## DRIVEWAY ACCESS

A **driveway access** is a portion of the **trafficway** at the end of a driveway providing access to property adjacent to a trafficway. A driveway access is not considered an intersection. See the **definition** and examples in the glossary on *page 13*.

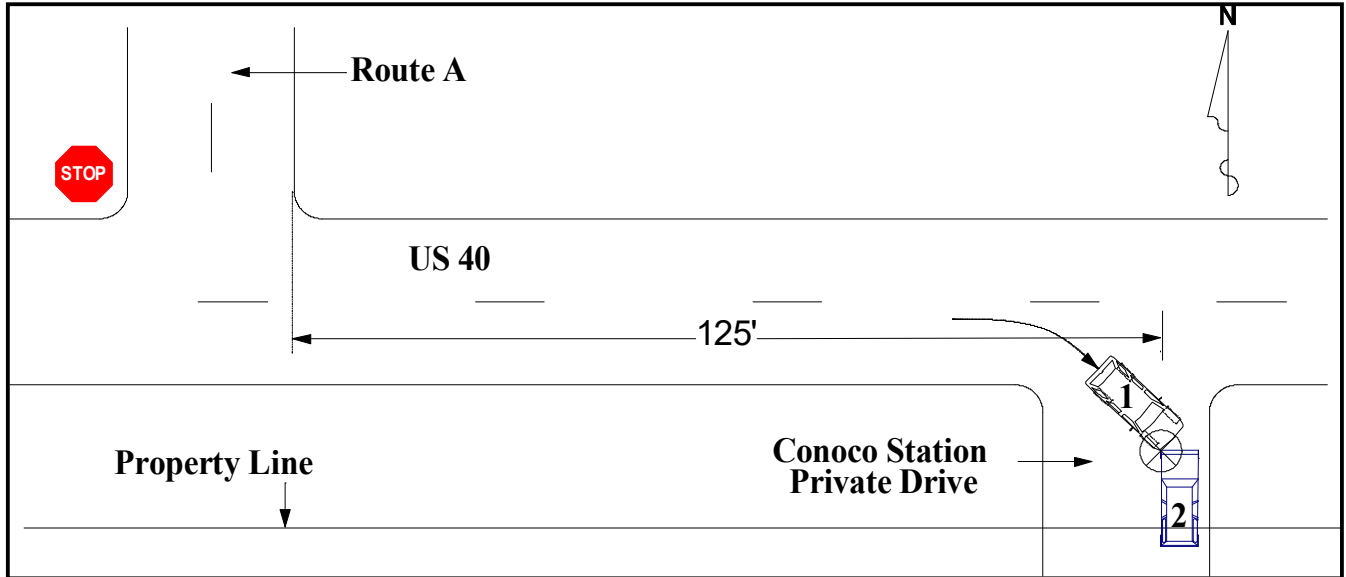

The crash above is located on US 40 because it occurred within the trafficway (right-of-way) of US 40. The private drive is not used in the "Intersecting" field because it provides access to the Conoco Station driveway. In the example, the crash is considered Off Roadway because the first harmful event was impact with a Parked Motor Vehicle (Front to Front) off of US 40.

CRASH TYPE	ROADWAY	NON-COLLISION		COLLISION INVOLVING			DIRECTIONAL ANALYSIS FOR IMPACT WITH MOTOR VEHICLE		
	<input type="checkbox"/> On Roadway <input checked="" type="checkbox"/> Off Roadway	<input type="checkbox"/> Overturning <input type="checkbox"/> Fire / Explosion <input type="checkbox"/> Immersion <input type="checkbox"/> Jackknife <input type="checkbox"/> Fell / Jumped From MV	<input type="checkbox"/> Cargo / Equip Loss / Shift <input type="checkbox"/> Other Non-Collision <input type="checkbox"/> Thrown or Falling Object	<input type="checkbox"/> Animal <input type="checkbox"/> Pedalcycle <input type="checkbox"/> Fixed Object <input type="checkbox"/> Other Object	<input type="checkbox"/> Pedestrian <input type="checkbox"/> Struck by Falling, Shifting Cargo or Anything Set in Motion by Motor Vehicle <input type="checkbox"/> Other Object	<input type="checkbox"/> Railway Vehicle <input type="checkbox"/> Motor Vehicle in Transport <input checked="" type="checkbox"/> Parked Motor Vehicle <input type="checkbox"/> Working Motor Vehicle <input type="checkbox"/> Other Non-Motorist	<input checked="" type="checkbox"/> Front to Front <input type="checkbox"/> Front to Rear <input type="checkbox"/> Rear to Rear <input type="checkbox"/> Rear to Side <input type="checkbox"/> Angle (Front to Side)	<input type="checkbox"/> Sideswipe (Same Dir.) <input type="checkbox"/> Sideswipe (Opp. Dir.) <input type="checkbox"/> Other (Explain) <input type="checkbox"/> Unknown (Explain)	

The crash is located on US 40 (Roadway Direction - "E"), 125 Feet After Route A. The direction of the intersecting roadway (Int. Dir.) is shown as "N" (northbound lane) because the location of the crash was measured to the northbound lane of Route A.

ON	RDWY. DIR.	DISTANCE FROM	LOCATION	INTERSECTING
US 40	E	125 Feet	<input checked="" type="checkbox"/> After <input type="checkbox"/> NA <input type="checkbox"/> Before <input type="checkbox"/> At	RT A
SPEED LIMIT	ROADWAY MAINTAINED BY			SPEED LIMIT
60	<input checked="" type="checkbox"/> State <input type="checkbox"/> County <input type="checkbox"/> Municipal <input type="checkbox"/> Private Property <input type="checkbox"/> Other			NA
TRAFFICWAY			ROADWAY ALIGNMENT	ROADWAY PROFILE
<input type="checkbox"/> One-Way <input checked="" type="checkbox"/> Two-Way, Not Divided <input type="checkbox"/> Two-Way, Not Divided, Continuous Center Turn Lane	<input type="checkbox"/> Two-Way, Divided, Unprotected Median <input type="checkbox"/> Two-Way, Divided, Positive Median Barrier <input type="checkbox"/> Other <input type="checkbox"/> Unknown		<input checked="" type="checkbox"/> Straight <input type="checkbox"/> Curve <input type="checkbox"/> Unknown (Explain)	<input checked="" type="checkbox"/> Level <input type="checkbox"/> Downhill <input type="checkbox"/> Dip <input type="checkbox"/> Uphill <input type="checkbox"/> Hillcrest <input type="checkbox"/> Unknown (Explain)
INTERSECTION TYPE	PERPENDICULAR	ANGLED / SKEWED	ROUNDBOUNT / TRAFFIC CIRCLE	ROADWAY CONDITION
<input checked="" type="checkbox"/> NA <input type="checkbox"/> T-Intersection	<input type="checkbox"/> Cross Intersection (4-Way) <input type="checkbox"/> T-Intersection	<input type="checkbox"/> Y-Intersection <input type="checkbox"/> Five or More Legs and Not Circular	<input type="checkbox"/> Roundabout <input type="checkbox"/> Other Circular Intersection <input type="checkbox"/> Other (Explain) <input type="checkbox"/> Unknown (Explain)	1
			Enter Codes	ROADWAY SURFACE
				1
			LIGHT CONDITION	WEATHER / ENVIRON CONDITION
			1	1

The sequence of events (*Section 7C*) for vehicle #1 is "Making Right Turn" (3) and "Collision Inv. Parked MV" (35). The sequence of events for vehicle #2 is "Stopped in Traffic" (12) and "Collision Inv. MV in Transport" (34).

Vehicle #1

7C, VEHICLE ACTION / SEQUENCE OF EVENTS CODES	
SEQUENCE OF EVENTS CODES	<input type="checkbox"/> Unknown
3 35	

Vehicle #2

7C, VEHICLE ACTION / SEQUENCE OF EVENTS CODES	
SEQUENCE OF EVENTS CODES	<input type="checkbox"/> Unknown
12 34	

## PARKING LOTS / PRIVATE ROADS

See examples of [private property crashes](#) on *page 46*.

A parking lot is an area used primarily for parking road vehicles. When paved and marked it commonly includes parking stalls, parking lot aisles, and parking lot ways.

Parking lot ways are land ways used primarily for vehicle circulation within parking lots and for vehicular access to parking lot aisles. Parking lot ways in parking lots open to the public are trafficways.

Parking lot aisles are used primarily for vehicular access to parking stalls. Parking lot aisles are not trafficways.

Parking stalls are reserved primarily for parked road vehicles. Parking stalls are not trafficways.

### Example #1

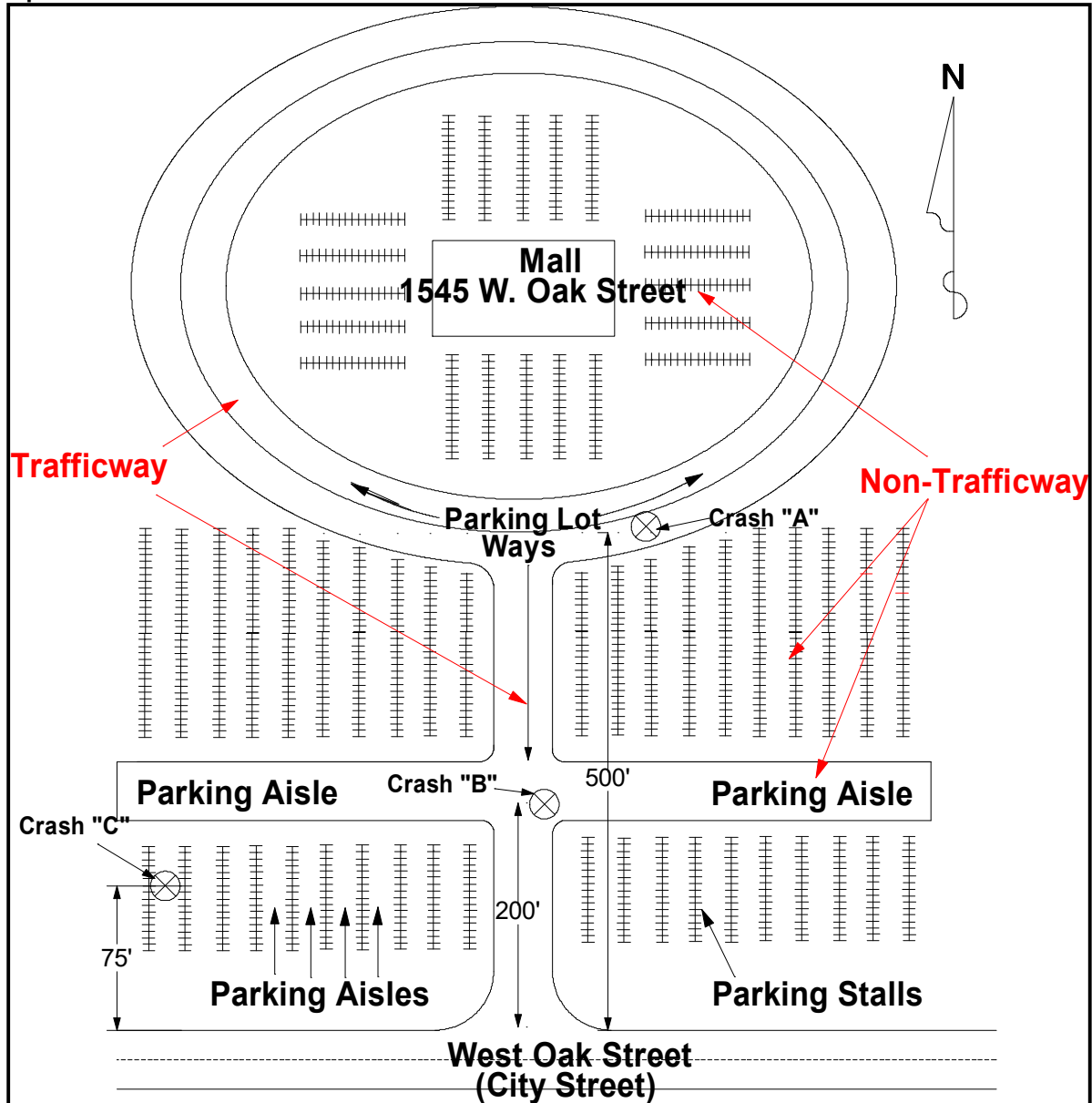

**Crash “A”:**

Crash “A” occurred on the parking lot way, which is considered a trafficway. The crash is located On PP Parking Lot at 1545 West Oak ST (Roadway Direction - “NA”), 500 Feet North of CST West Oak ST. *Location* is shown as “NA” because the crash occurred on private property.

ON PP Parking Lot At 1545 West Oak ST		RDWY. DIR. NA	DISTANCE FROM 500 Feet Miles	LOCATION <input type="checkbox"/> After <input checked="" type="checkbox"/> NA <input type="checkbox"/> Before <input type="checkbox"/> At	INTERSECTING North Of CST West Oak ST
SPEED LIMIT NA	ROADWAY MAINTAINED BY <input type="checkbox"/> Unknown <input type="checkbox"/> State <input type="checkbox"/> County <input type="checkbox"/> Municipal <input checked="" type="checkbox"/> Private Property <input type="checkbox"/> Other				SPEED LIMIT INT. DIR. GEO — CODE NA NA NA
TRAFFICWAY <input type="checkbox"/> One-Way <input checked="" type="checkbox"/> Two-Way, Not Divided <input type="checkbox"/> Two-Way, Divided; Unprotected Median <input type="checkbox"/> Other <input type="checkbox"/> Two-Way, Not Divided; Continuous Center Turn Lane <input type="checkbox"/> Two-Way, Divided; Positive Median Barrier <input type="checkbox"/> Unknown			ROADWAY ALIGNMENT <input checked="" type="checkbox"/> Straight <input type="checkbox"/> Curve <input type="checkbox"/> Unknown (Explain)	ROADWAY PROFILE <input checked="" type="checkbox"/> Level <input type="checkbox"/> Downhill <input type="checkbox"/> Dip <input type="checkbox"/> Uphill <input type="checkbox"/> Hillcrest <input type="checkbox"/> Unknown (Explain)	

**Crash “B”:**

Crash “B” occurred on the parking lot way, which is considered a trafficway. The crash is located On PP Parking Lot at 1545 West Oak ST (Roadway Direction - “NA”), 200 Feet North of CST West Oak ST. *Location* is shown as “NA” because the crash occurred on private property.

ON PP Parking Lot At 1545 West Oak ST		RDWY. DIR. NA	DISTANCE FROM 200 Feet Miles	LOCATION <input type="checkbox"/> After <input checked="" type="checkbox"/> NA <input type="checkbox"/> Before <input type="checkbox"/> At	INTERSECTING North Of CST West Oak ST
SPEED LIMIT NA	ROADWAY MAINTAINED BY <input type="checkbox"/> Unknown <input type="checkbox"/> State <input type="checkbox"/> County <input type="checkbox"/> Municipal <input checked="" type="checkbox"/> Private Property <input type="checkbox"/> Other				SPEED LIMIT INT. DIR. GEO — CODE NA NA NA
TRAFFICWAY <input type="checkbox"/> One-Way <input checked="" type="checkbox"/> Two-Way, Not Divided <input type="checkbox"/> Two-Way, Divided; Unprotected Median <input type="checkbox"/> Other <input type="checkbox"/> Two-Way, Not Divided; Continuous Center Turn Lane <input type="checkbox"/> Two-Way, Divided; Positive Median Barrier <input type="checkbox"/> Unknown			ROADWAY ALIGNMENT <input checked="" type="checkbox"/> Straight <input type="checkbox"/> Curve <input type="checkbox"/> Unknown (Explain)	ROADWAY PROFILE <input checked="" type="checkbox"/> Level <input type="checkbox"/> Downhill <input type="checkbox"/> Dip <input type="checkbox"/> Uphill <input type="checkbox"/> Hillcrest <input type="checkbox"/> Unknown (Explain)	

**Crash “C”:**

Crash “C” occurred in a parking aisle, which is not considered a trafficway. The crash is located On PP Parking Lot at 1545 West Oak ST (Roadway Direction - “NA”), 75 Feet North of CST West Oak ST. *Location* is shown as “NA” because the crash occurred on private property.

ON PP Parking Lot At 1545 West Oak ST		RDWY. DIR. NA	DISTANCE FROM 75 Feet Miles	LOCATION <input type="checkbox"/> After <input checked="" type="checkbox"/> NA <input type="checkbox"/> Before <input type="checkbox"/> At	INTERSECTING North Of CST West Oak ST
SPEED LIMIT NA	ROADWAY MAINTAINED BY <input type="checkbox"/> Unknown <input type="checkbox"/> State <input type="checkbox"/> County <input type="checkbox"/> Municipal <input checked="" type="checkbox"/> Private Property <input type="checkbox"/> Other				SPEED LIMIT INT. DIR. GEO — CODE NA NA NA
TRAFFICWAY <input type="checkbox"/> One-Way <input type="checkbox"/> Two-Way, Not Divided <input type="checkbox"/> Two-Way, Divided; Unprotected Median <input checked="" type="checkbox"/> Other <input type="checkbox"/> Two-Way, Not Divided; Continuous Center Turn Lane <input type="checkbox"/> Two-Way, Divided; Positive Median Barrier <input type="checkbox"/> Unknown			ROADWAY ALIGNMENT <input checked="" type="checkbox"/> Straight <input type="checkbox"/> Curve <input type="checkbox"/> Unknown (Explain)	ROADWAY PROFILE <input checked="" type="checkbox"/> Level <input type="checkbox"/> Downhill <input type="checkbox"/> Dip <input type="checkbox"/> Uphill <input type="checkbox"/> Hillcrest <input type="checkbox"/> Unknown (Explain)	

**Example #2:**

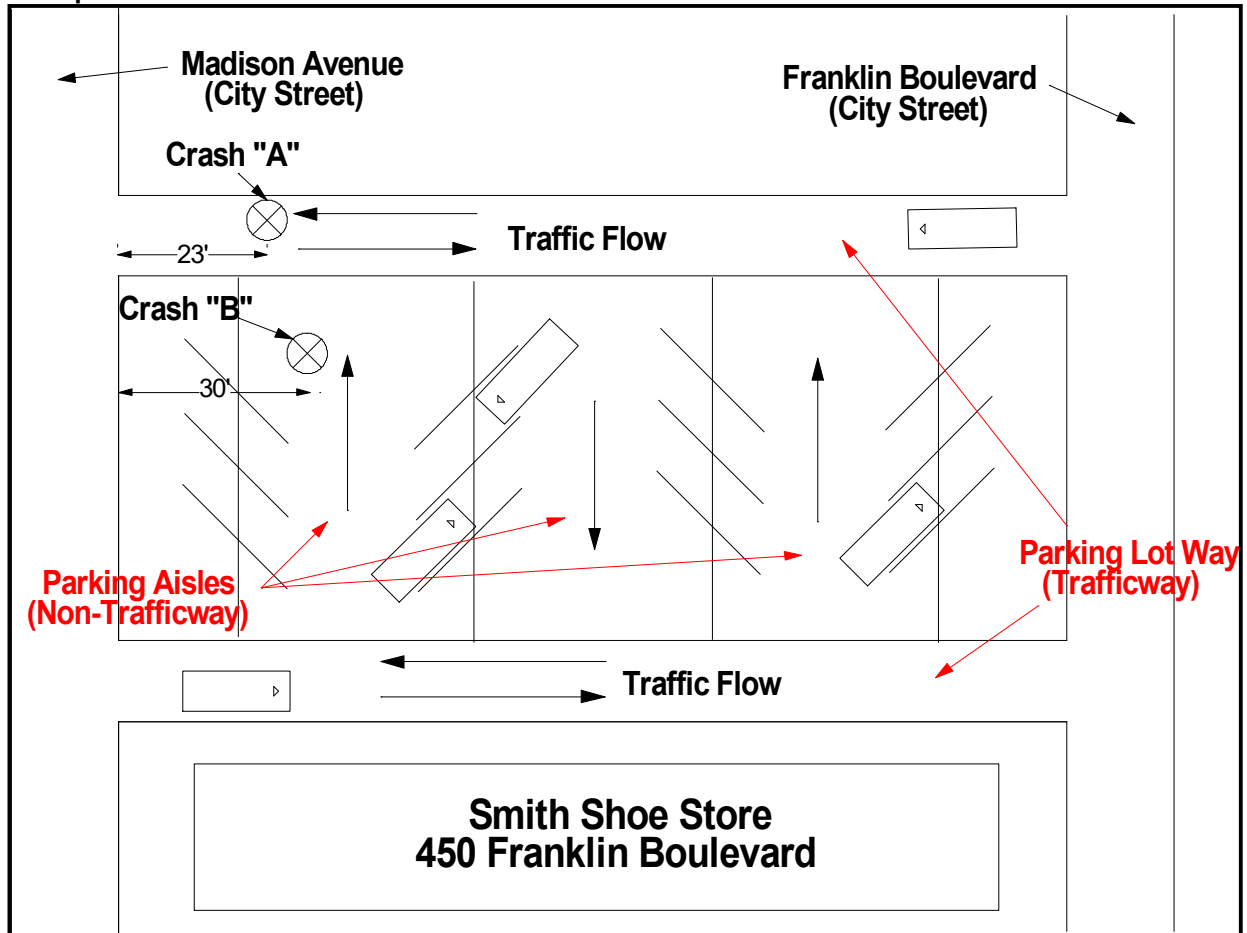

**Crash "A":**

Crash "A" occurred on a parking lot way, which is considered a trafficway. The crash is located On PP Parking Lot at 450 Franklin BLVD (Roadway Direction - "NA"), 23 Feet East of CST Madison AVE. *Location* is shown as "NA" because the crash occurred on private property.

ON PP Parking Lot At 450 Franklin BLVD		RDWY. DIR. NA	DISTANCE FROM 23 Feet Miles	LOCATION <input type="checkbox"/> After <input checked="" type="checkbox"/> NA <input type="checkbox"/> Before <input type="checkbox"/> At	INTERSECTING East Of CST Madison AVE
SPEED LIMIT NA	ROADWAY MAINTAINED BY <input type="checkbox"/> State <input type="checkbox"/> County <input type="checkbox"/> Municipal <input checked="" type="checkbox"/> Private Property <input type="checkbox"/> Other				SPEED LIMIT INT. DIR. GEO — CODE NA NA NA
TRAFFICWAY <input type="checkbox"/> One-Way <input checked="" type="checkbox"/> Two-Way; Not Divided <input type="checkbox"/> Two-Way; Divided; Unprotected Median <input type="checkbox"/> Other <input type="checkbox"/> Two-Way; Not Divided; Continuous Center Turn Lane <input type="checkbox"/> Two-Way; Divided; Positive Median Barrier <input type="checkbox"/> Unknown			ROADWAY ALIGNMENT <input checked="" type="checkbox"/> Straight <input type="checkbox"/> Curve <input type="checkbox"/> Unknown (Explain)		ROADWAY PROFILE <input checked="" type="checkbox"/> Level <input type="checkbox"/> Downhill <input type="checkbox"/> Dip <input type="checkbox"/> Uphill <input type="checkbox"/> Hillcrest <input type="checkbox"/> Unknown (Explain)

**Crash "B":**

Crash "B" occurred in the parking aisle, which is not considered a trafficway. The crash is located On PP Parking Lot at 450 Franklin BLVD (Roadway Direction - "NA"), 30 Feet East of CST Madison AVE. *Location* is shown as "NA" because the crash occurred on private property.

ON PP Parking Lot At 450 Franklin BLVD		RDWY. DIR. NA	DISTANCE FROM 30 Feet Miles	LOCATION <input type="checkbox"/> After <input checked="" type="checkbox"/> NA <input type="checkbox"/> Before <input type="checkbox"/> At	INTERSECTING East Of CST Madison AVE
SPEED LIMIT NA	ROADWAY MAINTAINED BY <input type="checkbox"/> State <input type="checkbox"/> County <input type="checkbox"/> Municipal <input checked="" type="checkbox"/> Private Property <input type="checkbox"/> Other				SPEED LIMIT INT. DIR. GEO — CODE NA NA NA
TRAFFICWAY <input type="checkbox"/> One-Way <input type="checkbox"/> Two-Way; Not Divided <input type="checkbox"/> Two-Way; Divided; Unprotected Median <input checked="" type="checkbox"/> Other <input type="checkbox"/> Two-Way; Not Divided; Continuous Center Turn Lane <input type="checkbox"/> Two-Way; Divided; Positive Median Barrier <input type="checkbox"/> Unknown			ROADWAY ALIGNMENT <input checked="" type="checkbox"/> Straight <input type="checkbox"/> Curve <input type="checkbox"/> Unknown (Explain)		ROADWAY PROFILE <input checked="" type="checkbox"/> Level <input type="checkbox"/> Downhill <input type="checkbox"/> Dip <input type="checkbox"/> Uphill <input type="checkbox"/> Hillcrest <input type="checkbox"/> Unknown (Explain)

**Example #3:**

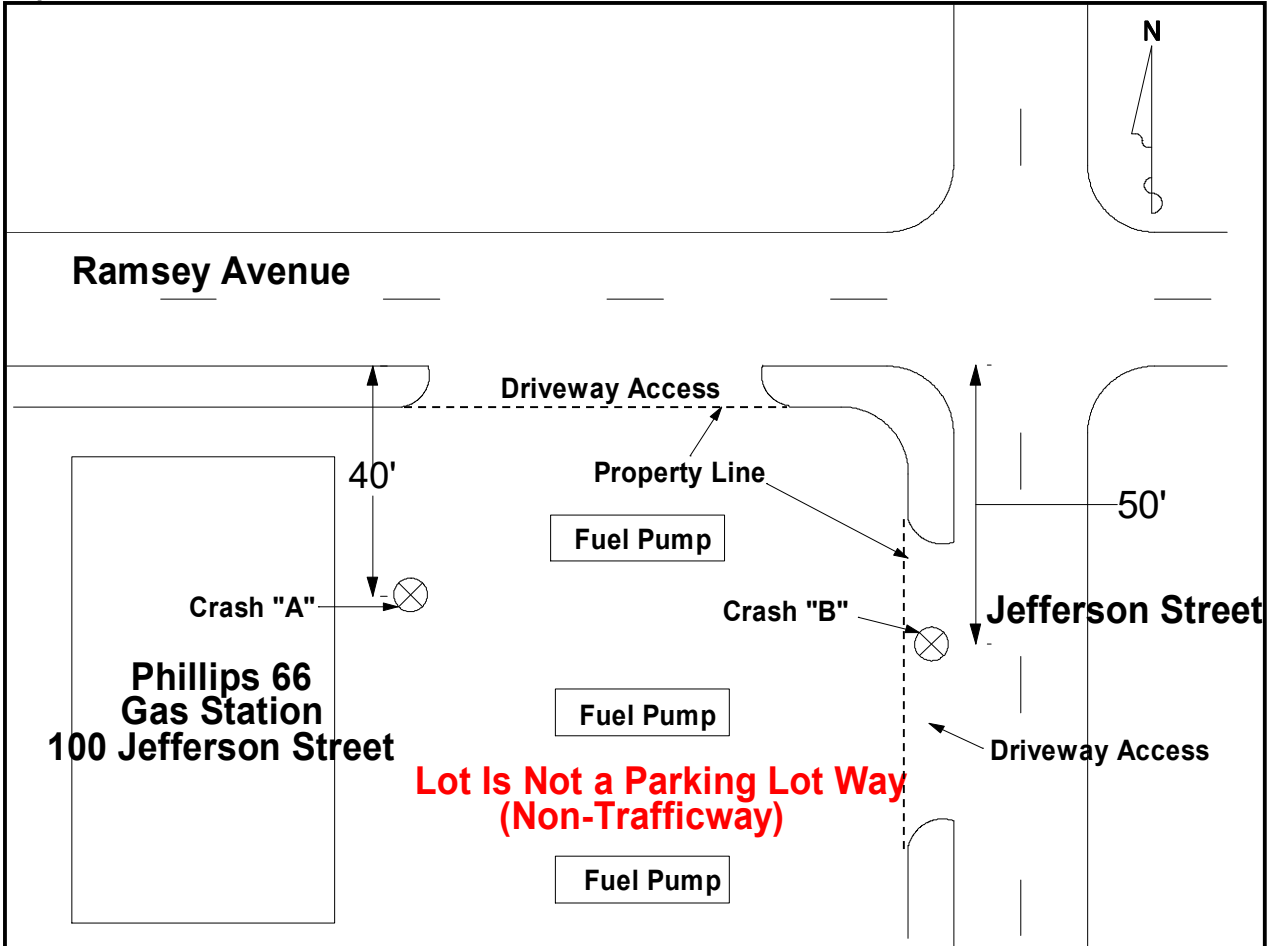

**Crash "A":**

Crash "A" occurred on the gas station parking lot, which is not considered a trafficway. The crash is located On Parking Lot at 100 Jefferson ST (Roadway Direction - "NA"), 40 Feet South of CST Ramsey AVE. Location is shown as "NA" because the crash occurred on private property.

ON PP Parking Lot At 100 Jefferson ST		RDWY. DIR. NA	DISTANCE FROM 40 <input type="checkbox"/> NA Feet	LOCATION <input type="checkbox"/> After <input checked="" type="checkbox"/> NA	INTERSECTING South Of CST Ramsey AVE
SPEED LIMIT NA	ROADWAY MAINTAINED BY <input type="checkbox"/> Unknown <input type="checkbox"/> State <input type="checkbox"/> County <input type="checkbox"/> Municipal <input checked="" type="checkbox"/> Private Property <input type="checkbox"/> Other			<input type="checkbox"/> Before	SPEED LIMIT NA
TRAFFICWAY <input type="checkbox"/> One-Way <input type="checkbox"/> Two-Way, Not Divided <input type="checkbox"/> Two-Way, Divided; Unprotected Median <input checked="" type="checkbox"/> Other <input type="checkbox"/> Two-Way, Not Divided; Continuous Center Turn Lane <input type="checkbox"/> Two-Way, Divided; Positive Median Barrier <input type="checkbox"/> Unknown				<input type="checkbox"/> At	INT. DIR. NA
				ROADWAY ALIGNMENT <input checked="" type="checkbox"/> Straight <input type="checkbox"/> Curve <input type="checkbox"/> Unknown (Explain)	GEO — CODE NA
					ROADWAY PROFILE <input checked="" type="checkbox"/> Level <input type="checkbox"/> Downhill <input type="checkbox"/> Dip <input type="checkbox"/> Uphill <input type="checkbox"/> Hillcrest <input type="checkbox"/> Unknown (Explain)

**Crash "B":**

Crash "B" occurred in the driveway access from Jefferson Street to the gas station parking lot. The driveway access is considered part of the trafficway. The crash is located On CST Jefferson ST (Roadway Direction - "S"), 50 Feet After CST Ramsey AVE. The direction of the intersecting roadway (Int. Dir.) is "E" because the location was measured to the eastbound lane of CST Ramsey AVE.

ON CST Jefferson ST		RDWY. DIR. S	DISTANCE FROM 50 <input type="checkbox"/> NA Feet	LOCATION <input checked="" type="checkbox"/> After <input type="checkbox"/> NA	INTERSECTING CST Ramsey AVE	
SPEED LIMIT 30	ROADWAY MAINTAINED BY <input type="checkbox"/> Unknown <input type="checkbox"/> State <input type="checkbox"/> County <input checked="" type="checkbox"/> Municipal <input type="checkbox"/> Private Property <input type="checkbox"/> Other			<input type="checkbox"/> Before	SPEED LIMIT NA	
TRAFFICWAY <input type="checkbox"/> One-Way <input checked="" type="checkbox"/> Two-Way, Not Divided <input type="checkbox"/> Two-Way, Divided; Unprotected Median <input type="checkbox"/> Other <input type="checkbox"/> Two-Way, Not Divided; Continuous Center Turn Lane <input type="checkbox"/> Two-Way, Divided; Positive Median Barrier <input type="checkbox"/> Unknown				<input type="checkbox"/> At	INT. DIR. E	
				ROADWAY ALIGNMENT <input checked="" type="checkbox"/> Straight <input type="checkbox"/> Curve <input type="checkbox"/> Unknown (Explain)	GEO — CODE NA	
					ROADWAY PROFILE <input checked="" type="checkbox"/> Level <input type="checkbox"/> Downhill <input type="checkbox"/> Dip <input type="checkbox"/> Uphill <input type="checkbox"/> Hillcrest <input type="checkbox"/> Unknown (Explain)	
INTERSECTION TYPE <input checked="" type="checkbox"/> NA		PERPENDICULAR <input type="checkbox"/> Cross Intersection (4-Way) <input type="checkbox"/> Y-Intersection <input type="checkbox"/> T-Intersection	ANGLED / SKEWED <input type="checkbox"/> Five or More Legs and Not Circular	ROUNDABOUT / TRAFFIC CIRCLE <input type="checkbox"/> Roundabout <input type="checkbox"/> Other Circular Intersection <input type="checkbox"/> Other (Explain) <input type="checkbox"/> Unknown (Explain)	Enter Codes	ROADWAY CONDITION 1
					LIGHT CONDITION 2	ROADWAY SURFACE 2
					WEATHER / ENVIRON CONDITION	

**Example #4:**

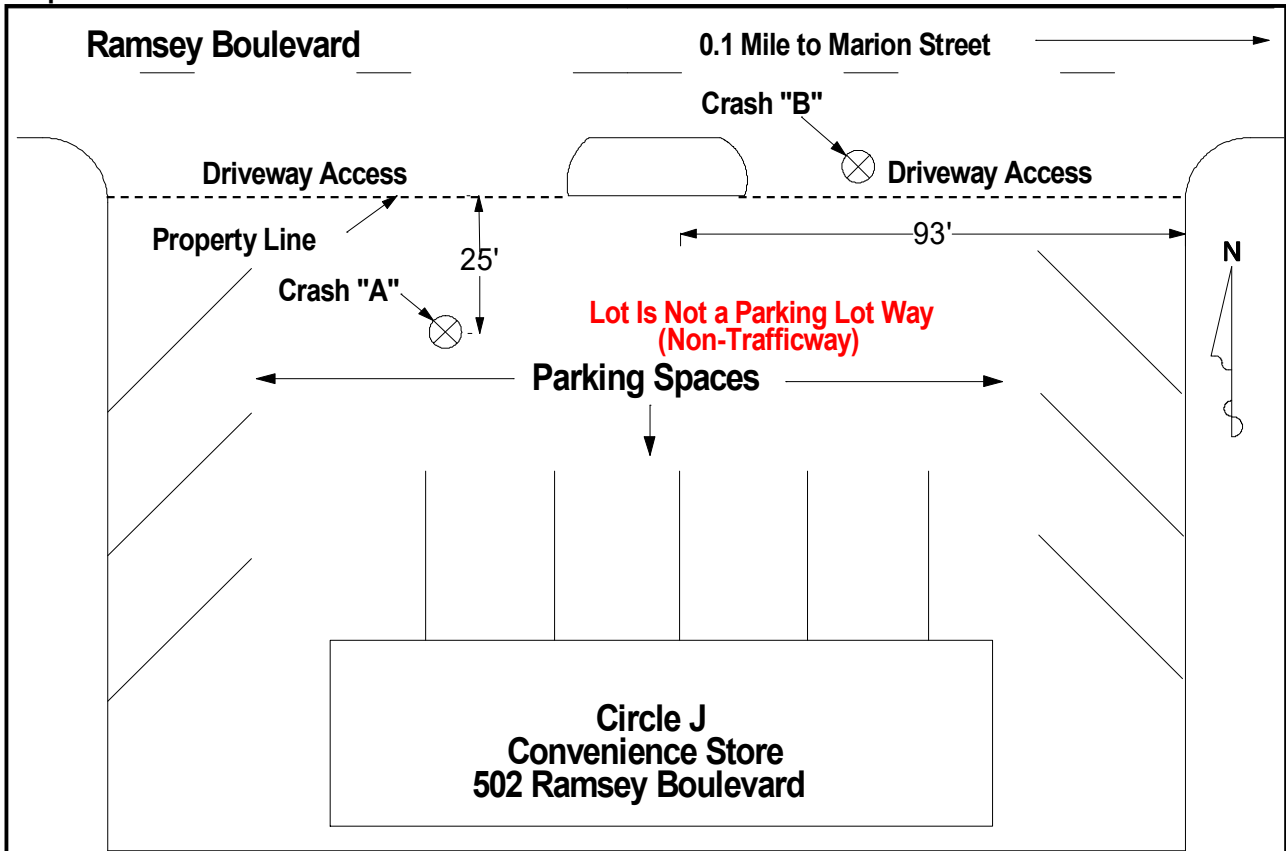

**Crash "A":**

Crash "A" occurred on the convenience store parking lot, which is not considered a trafficway. The crash is located On PP Parking Lot at 502 Ramsey BLVD (Roadway Direction - "NA"), 25 Feet South of CST Ramsey BLVD. *Location* is shown as "NA" because the crash occurred on private property.

ON PP Parking Lot At 502 Ramsey BLVD		RDWY. DIR. NA	DISTANCE FROM 25 Feet Miles	LOCATION <input type="checkbox"/> After <input checked="" type="checkbox"/> NA <input type="checkbox"/> Before <input type="checkbox"/> At	INTERSECTING South Of CST Ramsey BLVD
SPEED LIMIT NA	ROADWAY MAINTAINED BY <input type="checkbox"/> Unknown <input type="checkbox"/> State <input type="checkbox"/> County <input type="checkbox"/> Municipal <input checked="" type="checkbox"/> Private Property <input type="checkbox"/> Other				SPEED LIMIT NA
TRAFFICWAY <input type="checkbox"/> One-Way <input type="checkbox"/> Two-Way, Not Divided <input type="checkbox"/> Two-Way, Divided, Unprotected Median <input checked="" type="checkbox"/> Other <input type="checkbox"/> Two-Way, Not Divided, Continuous Center Turn Lane <input type="checkbox"/> Two-Way, Divided, Positive Median Barrier <input type="checkbox"/> Unknown		ROADWAY ALIGNMENT <input checked="" type="checkbox"/> Straight <input type="checkbox"/> Curve <input type="checkbox"/> Unknown (Explain)		ROADWAY PROFILE <input checked="" type="checkbox"/> Level <input type="checkbox"/> Downhill <input type="checkbox"/> Dip <input type="checkbox"/> Uphill <input type="checkbox"/> Hillcrest <input type="checkbox"/> Unknown (Explain)	

**Crash "B":**

Crash "B" occurred in the driveway access from Ramsey Boulevard to the convenience store parking lot. The driveway access is considered part of the trafficway. The crash is located On CST Ramsey BLVD (Roadway Direction - "E"), 0.1 Mile Before CST Marion ST. The direction of the intersecting roadway (Int. Dir.) is "S" because the location was measured to the southbound lane of CST Marion ST.

ON CST Ramsey BLVD		RDWY. DIR. E	DISTANCE FROM 0.1 Miles	LOCATION <input type="checkbox"/> After <input type="checkbox"/> NA <input checked="" type="checkbox"/> Before <input type="checkbox"/> At	INTERSECTING CST Marion ST
SPEED LIMIT 35	ROADWAY MAINTAINED BY <input type="checkbox"/> Unknown <input type="checkbox"/> State <input type="checkbox"/> County <input checked="" type="checkbox"/> Municipal <input type="checkbox"/> Private Property <input type="checkbox"/> Other				SPEED LIMIT NA
TRAFFICWAY <input type="checkbox"/> One-Way <input checked="" type="checkbox"/> Two-Way, Not Divided <input type="checkbox"/> Two-Way, Divided, Unprotected Median <input type="checkbox"/> Other <input type="checkbox"/> Two-Way, Not Divided, Continuous Center Turn Lane <input type="checkbox"/> Two-Way, Divided, Positive Median Barrier <input type="checkbox"/> Unknown		ROADWAY ALIGNMENT <input checked="" type="checkbox"/> Straight <input type="checkbox"/> Curve <input type="checkbox"/> Unknown (Explain)		ROADWAY PROFILE <input checked="" type="checkbox"/> Level <input type="checkbox"/> Downhill <input type="checkbox"/> Dip <input type="checkbox"/> Uphill <input type="checkbox"/> Hillcrest <input type="checkbox"/> Unknown (Explain)	
INTERSECTION TYPE <input checked="" type="checkbox"/> NA <input type="checkbox"/> Cross Intersection (4-Way) <input type="checkbox"/> T-Intersection		ANGLED / SKEWED <input type="checkbox"/> Y-Intersection <input type="checkbox"/> Five or More Legs and Not Circular		ROUNDABOUT / TRAFFIC CIRCLE <input type="checkbox"/> Roundabout <input type="checkbox"/> Other Circular Intersection <input type="checkbox"/> Other (Explain) <input type="checkbox"/> Unknown (Explain)	
Enter Codes		ROADWAY CONDITION 2	LIGHT CONDITION 1	WEATHER / ENVIRON CONDITION 2	ROADWAY SURFACE 2

**Example #5:**

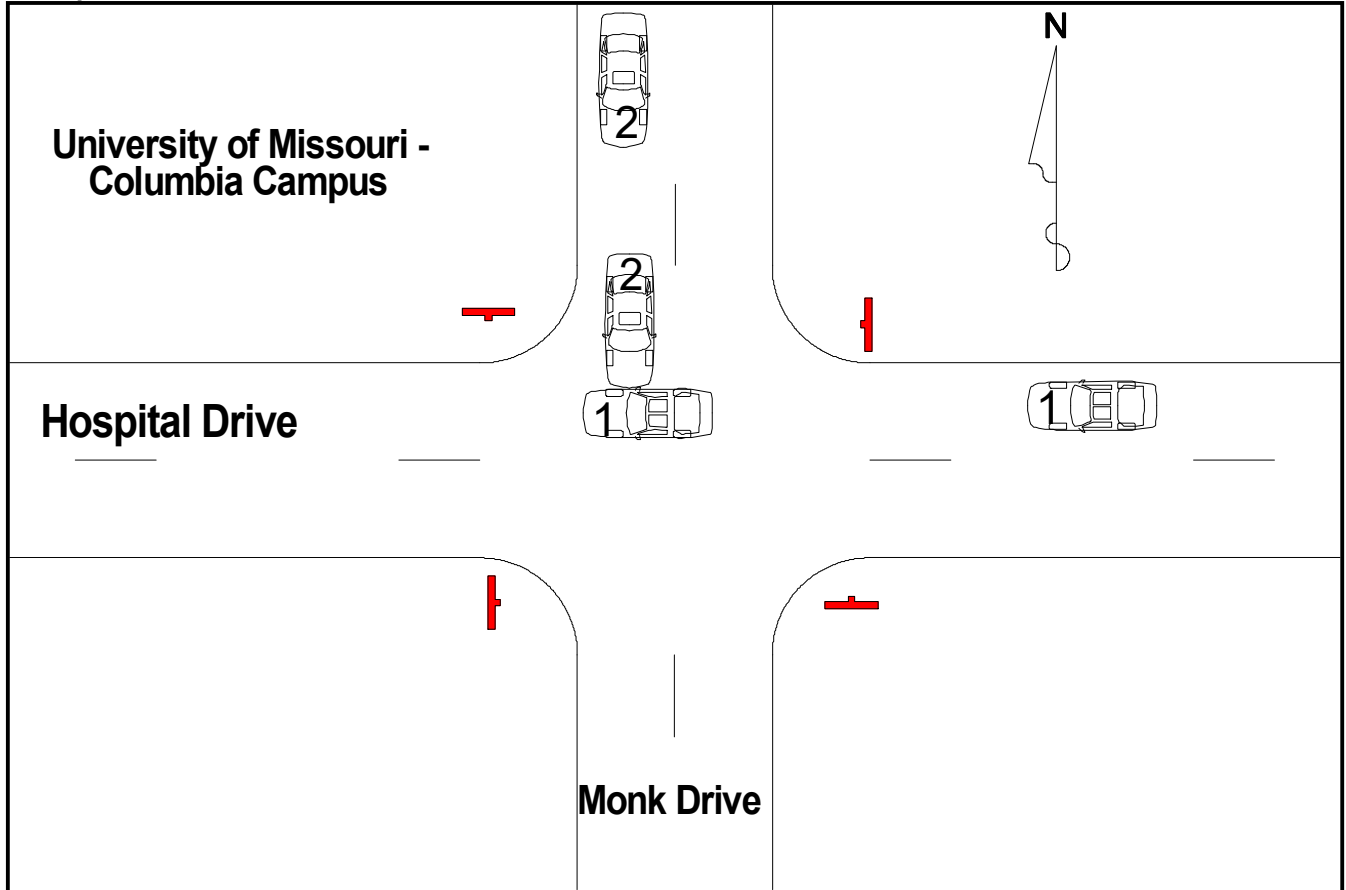

The roadways on the University of Missouri Campus are treated as private roadways even though they are maintained by the state. This occurs in several other locations such as other state college campuses, state parks, and other state-owned locations. In these cases, use the designator PVT.

The above crash is located On PVT Hospital DR (Roadway Direction - "W"), At PVT Monk DR. The direction of the intersecting roadway (Int. Dir.) can be shown either as "N" (northbound lane) or "S" (southbound lane) because it occurred within the intersection.

ON PVT Hospital DR		RDWY. DIR. W	DISTANCE FROM <input checked="" type="checkbox"/> NA Feet Miles	LOCATION <input type="checkbox"/> After <input type="checkbox"/> NA <input type="checkbox"/> Before <input checked="" type="checkbox"/> At	INTERSECTING PVT Monk DR	
SPEED LIMIT 20	ROADWAY MAINTAINED BY <input checked="" type="checkbox"/> State <input type="checkbox"/> County <input type="checkbox"/> Municipal <input type="checkbox"/> Private Property <input type="checkbox"/> Other				SPEED LIMIT 20	INT. DIR. S
TRAFFICWAY <input type="checkbox"/> One-Way <input checked="" type="checkbox"/> Two-Way; Not Divided <input type="checkbox"/> Two-Way; Divided; Unprotected Median <input type="checkbox"/> Other <input type="checkbox"/> Two-Way; Not Divided; Continuous Center Turn Lane <input type="checkbox"/> Two-Way; Divided; Positive Median Barrier <input type="checkbox"/> Unknown		ROADWAY ALIGNMENT <input checked="" type="checkbox"/> Straight <input type="checkbox"/> Curve <input type="checkbox"/> Unknown (Explain)		ROADWAY PROFILE <input checked="" type="checkbox"/> Level <input type="checkbox"/> Downhill <input type="checkbox"/> Dip <input type="checkbox"/> Uphill <input type="checkbox"/> Hillcrest <input type="checkbox"/> Unknown (Explain)		
INTERSECTION TYPE <input type="checkbox"/> NA <input checked="" type="checkbox"/> Cross Intersection (4-Way) <input type="checkbox"/> T-Intersection		ANGLED / SKEWED <input type="checkbox"/> Y-Intersection <input type="checkbox"/> Five or More Legs and Not Circular		ROUNDABOUT / TRAFFIC CIRCLE <input type="checkbox"/> Roundabout <input type="checkbox"/> Other (Explain) <input type="checkbox"/> Other Circular Intersection <input type="checkbox"/> Unknown (Explain)		Enter Codes ROADWAY CONDITION 1
LIGHT CONDITION 1		WEATHER / ENVIRON CONDITION 1		ROADWAY SURFACE 1		

# APPENDIX F

## Miscellaneous

### TIME CHART

ORDINARY TIME	MILITARY TIME	ORDINARY TIME	MILITARY TIME
1 a.m.-----	0100	1 p.m.-----	1300
2 a.m.-----	0200	2 p.m.-----	1400
3 a.m.-----	0300	3 p.m.-----	1500
4 a.m.-----	0400	4 p.m.-----	1600
5 a.m.-----	0500	5 p.m.-----	1700
6 a.m.-----	0600	6 p.m.-----	1800
7 a.m.-----	0700	7 p.m.-----	1900
8 a.m.-----	0800	8 p.m.-----	2000
9 a.m.-----	0900	9 p.m.-----	2100
10 a.m.-----	1000	10 p.m.-----	2200
11 a.m.-----	1100	11 p.m.-----	2300
Noon-----	1200	Midnight-----	0000

### ROADWAY NAME ABBREVIATIONS

Avenue	AVE
Boulevard	BLVD
Circle	CIR
Court	CT
Cutoff	CUTOFF (Not abbreviated)
Drive	DR
Expressway	EXPY
Highway	HWY
Lane	LN
Parkway	PKWY
Place	PL
Road	RD
Street	ST
Terrace	TER
Trafficway	TRFY

### ROUTE DESIGNATION ABBREVIATIONS

IS	Interstate	CO	Connector for Wye Leg
US	U.S. Highway	EOR	East Outer Road
MO	State Numbered	NOR	North Outer Road
RT	State Lettered	SOR	South Outer Road
AL	Alternate Route	WOR	West Outer Road
LP	Loop (Interstates Only)	PVT	Private Road
BU	Business Route (US or MO only)	RV	Reversible
SP	Spur	RA	Rest Area
CST	City Street	WS	Weigh Station
RP	Ramp	ALY	Alley
CRD	County Road	BRIDGE	Bridge
PP	Private Property	ERM	Emergency Reference Marker
DOD	Department of Defense	COE	Corp of Engineers
FWS	Fish and Wildlife	NFS	National Forest Service
NPS	National Park Service	PK	Park Road



## VEHICLE COLOR ABBREVIATIONS

AME	Amethyst	DBL	Dk. Blue	MUL	Multicolored	TPE	Taupe
BGE	Beige	DGR	Dk. Green	MVE	Mauve	TRQ	Turquoise
BLK	Black	GLD	Gold	ONG	Orange	WHI	White
BLU	Blue	GRN	Green	PLE	Purple	YEL	Yellow
BRO	Brown	GRY	Gray	PNK	Pink	UNK	Unknown
BRZ	Bronze	LAV	Lavender	RED	Red		Color
CAM	Camouflage	LBL	Lt. Blue	SIL	Silver /		
COM	Chrome	LGR	Lt. Green		Aluminum		
CPR	Copper	MAR	Maroon /	TAN	Tan		
CRM	Cream		Burgundy	TEA	Teal		

**DIAGRAM OF A TRAFFICWAY**

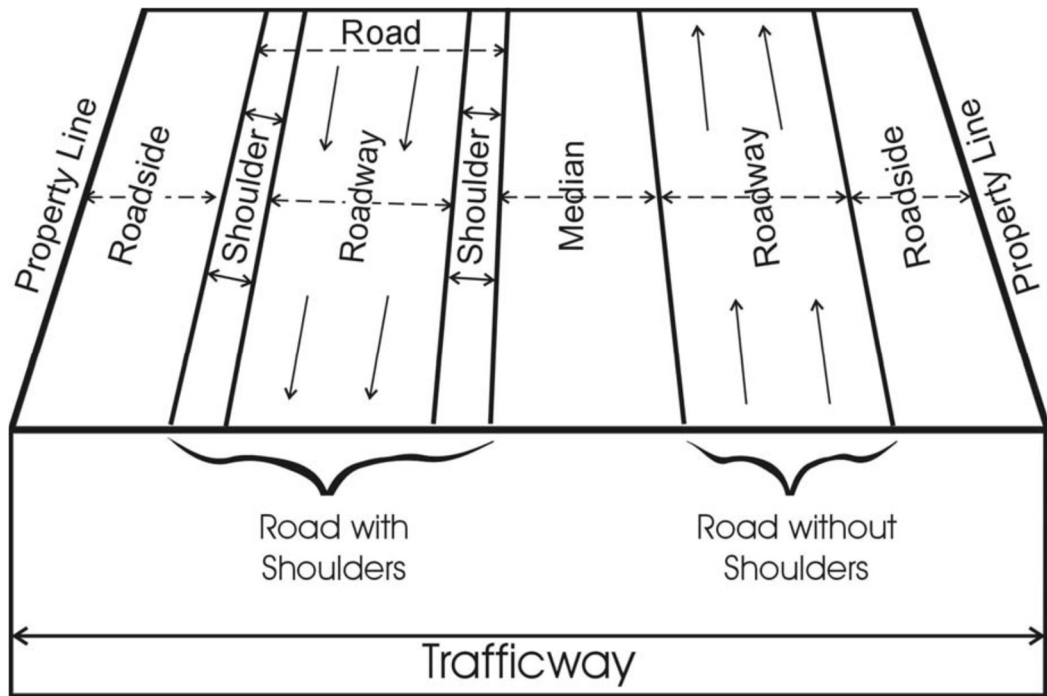

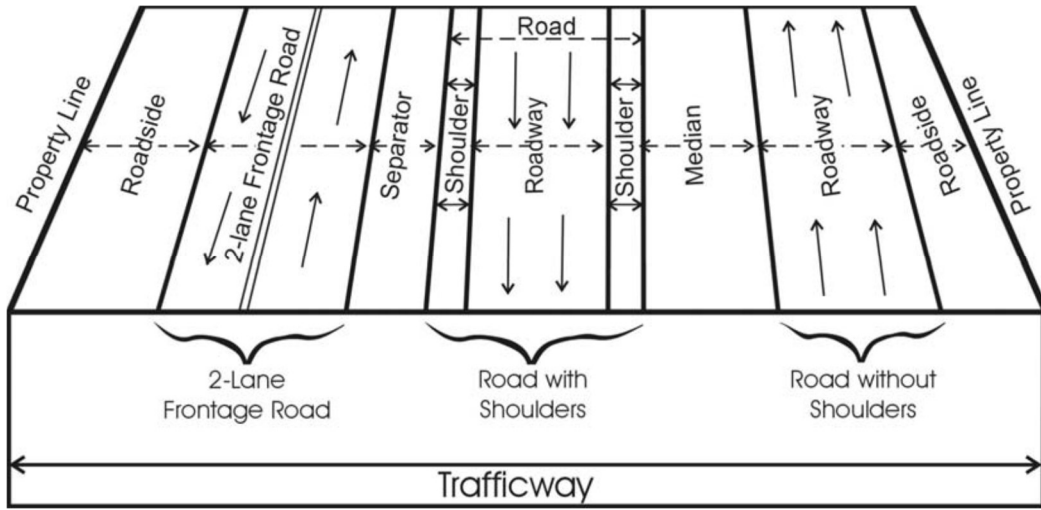

Trafficway with Frontage Road. Frontage road could be one or two-way.  
 (Source: ANSI D.16 - 2017 Manual on Classification of Motor Vehicle Crashes, 8<sup>th</sup> Edition).

## APPENDIX G

### Driver License Status and Type

Specific Situations Concerning Lic. Status and Lic. Type

	Status	Type	Endorsements
<b>Temporary Driving Permit / Privilege (Valid)</b>	Valid	(Type Issued)	
<b>Temporary Driving Permit / Privilege (Invalid)</b>	(Current Status)	(Type Issued)	
<b>Instruction Permit (Valid)</b>	Valid	Permit	
<b>Instruction Permit (Invalid)</b>	Canceled / Oth. Invalid	Permit	
<b>Limited Driving Privilege (Hardship Lic) - In Compliance with Permit</b>	Valid	(Type Issued)	
<b>Limited Driving Privilege (Hardship Lic) - Not in Compliance with Permit</b>	(Current Status)	(Type Issued)	
<b>Motorcycle Operator with valid MC permit</b>	Valid	Permit	No
<b>Motorcycle Operator with no permit or endorsement</b>	Canceled / Oth. Invalid	(Type Issued)	No
<b>Interlock Required Operator (Installed or not installed)</b>	(Current Status)	(Type Issued)	
<b>MO Resident with Out of State License</b>	(Current Status in State of Issuance)	(Current Type in State of Issuance)	
<b>Operator with an Assigned No. by DOR with Privilege Suspended, Revoked, Denied, etc.</b>	Suspended, Revoked, Denied....	Unlicensed	
<b>Operator with a license from a country other than U.S.</b>	Current status if known Unknown if cannot be determined	Type Issued if known Unknown if cannot be determined	

